

Disco 19-Inch Color Raster Video Display

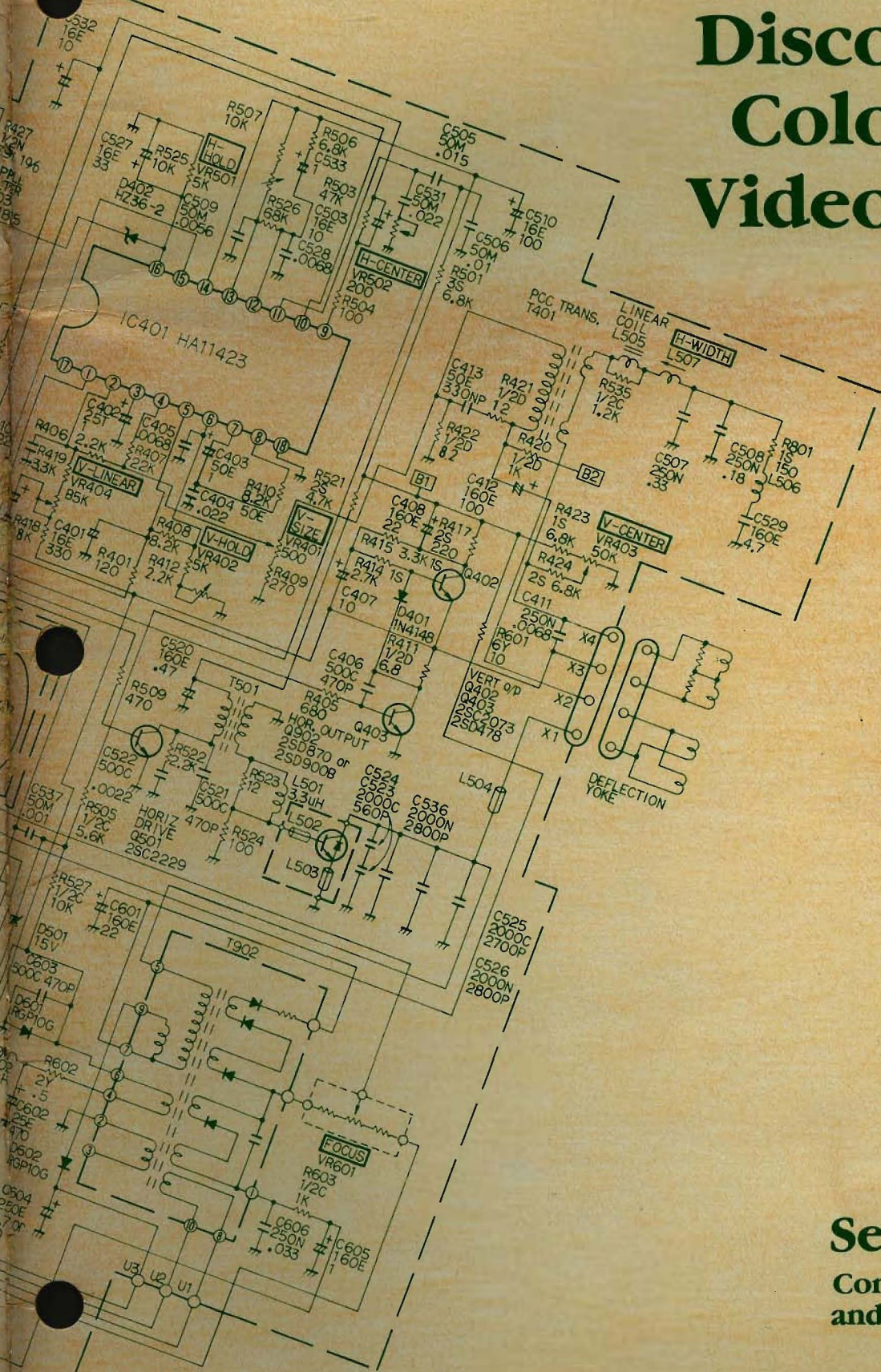

Service Manual
Complete with Schematic
and Illustrated Parts Lists

Warranty

Seller warrants that its printed-circuit boards and parts thereon are free from defects in material and workmanship under normal use and service for a period of ninety (90) days from date of shipment. Seller warrants that its video displays (in games supplied with displays) are free from defects in material and workmanship under normal use and service for a period of thirty (30) days from date of shipment. None of the Seller's other products or parts thereof are warranted.

If the products described in this manual fail to conform to this warranty, Sellers' sole liability shall be, at its option, to repair, replace, or credit Buyer's account for such products which are returned to Seller during said warranty period, provided:

- (a) Seller is promptly notified in writing upon discovery by Buyer that said products are defective;
- (b) Such products are returned prepaid to Sellers' plant; and
- (c) Seller's examination of said products discloses to Seller's satisfaction that such alleged defects existed and were not caused by accident, misuse, neglect, alteration, improper repair, installation or improper testing.

In no event shall Seller be liable for loss of profits, loss of use, incidental or consequential damages.

Except for any express warranty set forth in a written contract between Seller and Buyer which contract supersedes the terms of this order, this warranty is expressed in lieu of all other warranties expressed or implied, including the implied warranties of merchantability and fitness for a particular purpose, and of all other obligations or liabilities on the Seller's part, and it neither assumes nor authorizes any other person to assume for the Seller any other liabilities in connection with the sale of products under this order.

The use of any non-Atari parts may void your warranty, according to the terms of the warranty. The use of any non-Atari parts may also adversely affect the safety of your game and cause injury to yourself and others. Be very cautious in using non-Atari-supplied components with our games, in order to insure your safety.

Atari distributors are independent, being privately owned and operated. In their judgment they may sell parts or accessories other than Atari parts or accessories. Atari cannot be responsible for the quality, suitability or safety of any non-Atari part or any modification including labor which is performed by such distributor.

This document is and contains confidential trade secret information of Atari, Inc.

This document is loaned under confidential custody for the sole purpose of operation, maintenance or repair of Atari equipment and may not be used by or disclosed to any person for any other purpose whatever, and remains the property of Atari, Inc.

Neither it nor the information it contains may be reproduced, used, or disclosed to persons not having a need to know consistent with the purpose of the loan, without written consent of Atari, Inc.

Disco 19-Inch Color Raster Display Service Manual

Complete with Schematic and Illustrated Parts Lists

Display manufactured by
Disco Electronics Corp.
Taipei, Taiwan

© 1982 by Atari, Inc.

All rights reserved.

No part of this publication may be reproduced by any mechanical, photographic, or electronic process, or in the form of a phonographic recording, nor may it be stored in a retrieval system, transmitted, or otherwise copied for public or private use, without permission from the publisher.

This video display manual and its accompanying schematic diagrams are protected by U.S. Copyright Act of 1976.

This Act provides for increased penalties for violating federal copyright laws. Courts *can impound* infringing articles while legal action is pending. If infringers are convicted, courts can *order destruction* of the infringing articles.

In addition, the Act provides for payment of statutory damages of up to \$50,000 in certain cases. Infringers may also have to pay costs and attorneys' fees, fines up to \$25,000, and face an imprisonment of up to one year.

Atari will aggressively enforce its copyrights against any infringers. *We will use all legal means* to immediately halt any manufacture, distribution, or operation of a copy of video games made by us. Anyone who purchases such copies risks forfeiting such a game.

Published by:
ATARI, INC.
790 Sycamore Drive
P.O. Box 906
Milpitas, California 95035

Lithographed in the U.S.A. **11L**

Notice Regarding Non-ATARI Parts

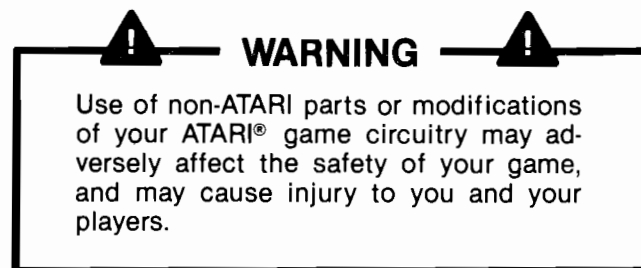

You may void the game warranty (printed on the inside back cover of this manual) if you do any of the following:

- substitute non-ATARI parts in the game
- modify or alter any circuits in the game by using kits or parts *not* supplied by Atari.

Table of Contents

1	Warnings and Cautions	
	A. Before You Start	1
	B. Safety Measures	2
	C. Cathode-Ray Tube Handling	2
	D. Replace with Proper Components	2
	E. Final Testing Before Reinstalling Display	2
2	Specifications	
	A. Power Input and Consumption	3
	B. Temperature and Humidity	3
	C. Current and Voltages	3
	D. CRT Specifications	3
	E. Connectors	4
	F. Monitor Input Signals	4
	G. Pattern Size	4
3	Control Adjustments	
	A. Brightness	5
	B. Horizontal Hold	5
	C. Vertical Hold	5
	D. Horizontal Positioning	5
	E. Vertical Positioning	5
	F. Horizontal Size	5
	G. Vertical Size	5
	H. Focus	5
4	Signal Test Points	
	A. RGB Signals	8
	B. Sync Signal	8
5	Details of Operation	
	A. Sync Separator	9
	B. Vertical and Horizontal Amplifiers	9
	C. Z Amplifiers (Red, Green, and Blue)	9
	D. Blanking	9
	E. High Voltage	10
	F. Line Input and Degaussing	10
	G. +115-Volt Regulated Supply	10

6	Repair	
	A. Cathode-Ray Tube Replacement	14
	B. Yoke Replacement	14
	C. Flyback Transformer Replacement	14
	D. CRT PCB Replacement	15
	E. Main PCB Replacement	15
7	Adjustments and Testing	
	A. Video B + Adjustment	16
	B. Purity Adjustments	16
	C. Convergence Adjustments	18
	D. Tracking Adjustments	19
8	Illustrated Parts Lists	
	Illustrations and Parts Lists Begin on Page	20
Appendices		
	Appendix A Waveforms	A-1
	Appendix B Glossary of Terms	B-1

List of Illustrations

Figure 1	Overview of Disco 19-Inch Color Raster Display	1
Figure 2	RGB Video Input Signals	4
Figure 3	Display Pattern Sizes	4
Figure 4	Adjustable Controls on CRT PCB	6
Figure 5	Adjustable Controls and Test Points on Main PCB	7
Figure 6	Block Diagram of the Disco 19-Inch Color Raster Display	11
Figure 7	Disco Display Schematic Diagram	12
Figure 8	Locations of Video B + Adjustment VR001 and Test Point A1	16
Figure 9	Purity and Convergence Adjustments	17
Figure 10	Locations of Tracking Adjustments on the CRT PCB	19
Figure 11	Main PCB Assembly	20
Figure 12	CRT PCB Assembly	27
Figure 13	Display Assembly	29

1 Warnings and Cautions

A. Before You Start

This color raster display has been built to Atari specifications by Disco Electronics Corp. This display is contained within a separate chassis inside the game cabinet. The Main printed-circuit board (PCB) is mounted to the display chassis under the cathode-ray tube (CRT). The CRT PCB is attached to the neck pins of the CRT.

Input signals for the display are supplied through a 6-pin harness connector on the Main PCB.

Never attempt to work on a display until you are familiar with servicing precautions and procedures necessary for high-voltage equipment. Remember, any video display has at least three sources of possible danger:

- Strong electrical shock, due to high voltage or AC line voltage
- X-ray radiation (if the display is out of adjustment)
- Implosion

Therefore, never modify any circuit in this display.

Perform servicing on a video display only after you are thoroughly familiar with all warnings and safety measures given in this chapter.

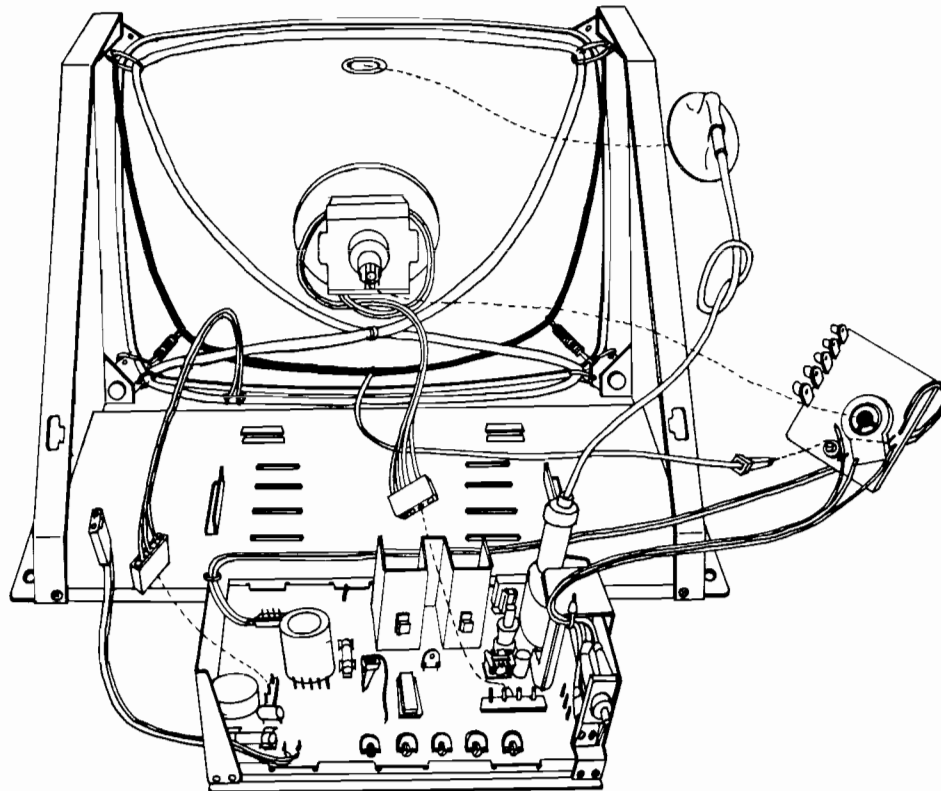

Figure 1 Overview of Disco 19-Inch Color Raster Display

⚠ WARNINGS ⚠

High Voltage

This display contains high voltages capable of delivering lethal quantities of energy. To avoid danger, do not attempt to service the chassis until you have observed all precautions necessary for working on high-voltage equipment.

X-Radiation

This chassis has been designed for minimum X-radiation hazard. However, to avoid possible exposure to soft X-radiation, it is imperative that you never modify the high-voltage circuitry.

Implosion Hazard

If you drop the display and the cathode-ray tube breaks, it will implode! Shattered glass and the yoke assembly can fly 6 feet or more from the implosion. Use care when replacing any display.

B. Safety Measures

Good safety habits will allow you to automatically take the proper precautions, even if you are rushed. Whenever you work on a display, always ground the chassis first. Also, use only one hand. This avoids the possibility of carelessly putting one hand on the chassis or ground and the other on an electrical connection. Doing so could cause a severe electrical shock.

If you service the Disco 19-Inch Color Raster Display on a test bench, use an isolation transformer or the power supply that came with the game. (Refer to the Power Supply Assembly parts list in the game manual for the Atari part number of the isolation transformer.) Do not use line voltage or a power supply from a black-and-white game, because the voltages produced by those sources will damage this display.

To prevent fire or shock hazard, never expose this display to moisture.

Periodically check for frayed insulation on the wires within the display. If frayed wires are found, replace them with the same gauge, insulation type, and thickness, length, and rating of wire. Always observe the original routing and length of harness wires.

Use extra precaution in the high-voltage circuitry areas of the display. If a short circuit occurs, replace any components that indicate they may have overheated.

C. Cathode-Ray Tube Handling

Wear safety goggles and heavy gloves for protection whenever you handle a cathode-ray tube (CRT). Keep other people away if they are not wearing safety goggles. Never lift the CRT by the neck; the neck should only be used to guide the lifting process.

Use extreme care when handling the CRT! Rough handling may cause it to implode. Do not nick or scratch the glass or subject any undue pressure upon the tube at any time.

If servicing the CRT, discharge the high voltage on the anode connection to chassis ground—not to the cabinet or other mounting parts. When discharging the anode, go from ground to the anode connection with a well-insulated 18-gauge jumper wire. Allow two minutes to pass and discharge the anode again.

D. Replace with Proper Components

Maintain the specified values of all components within the display. Failure to do so could cause a rise in the high voltage.

The cathode-ray tube of this display employs integral implosion protection. For continued safety, replace it only with a tube of the same type number. Refer to the parts lists in Chapter 8 of this manual. For continued product safety, use only exact replacement parts, especially for those parts identified in the parts lists with the ▲ symbol and on the schematic diagram with shading.

E. Final Testing Before Reinstalling Display

Before reinstalling this color display into the game, you must check the following:

1. Inspect all harness wiring within the display area. Be sure no wires or cables are pinched between the cabinet and other parts in the display.
2. Replace all protective devices such as insulating fishpaper, compartment covers, and shields.

2 Specifications

A. Power Input and Consumption

Line Voltage	120 VAC, within +10% and - 15%
Line Frequency	47-63 Hz
Power Consumption	150 W maximum

B. Temperature and Humidity

Ambient Air Temperature	0° to +55°C (+32° to +151°F)
Environmental Humidity	10-90%, noncondensing

C. Current and Voltages

CRT Anode Current (Average)	Less than 700 μ A
High Voltage	27-29 kV
B1	+115 V, within \pm 0.5 V (adjustable)
B2	+18 V, within \pm 2.0 V

D. CRT Specifications

Convergence Tolerance:

At Screen Center	0.010 inch (0.4 mm) maximum misconvergence
At Screen Edges	0.020 inch (0.7 mm) maximum misconvergence

Color Purity:

Practically uniform throughout the screen area after degaussing with a hand-held degaussing coil.

Scan Rates:

Horizontal	15.750 kHz, within \pm 500 Hz
Vertical	60 Hz, within \pm 5 Hz

CRT Type:

#19VKUP22, 19-inch, 90°

Tilt of Deflection Yoke:

Declination of a horizontal line is within 0.10 inch (2.54 mm) of CRT center markers.

E. Connectors

6-Pin Connector for Video Signals:

Pin 1	Not used
Pin 2	Sync (negative composite)
Pin 3	Ground
Pin 4	Blue input
Pin 5	Green input
Pin 6	Red input

2-Pin Connector for Power:

Pin 1	120 VAC
Pin 2	120 VAC

F. Monitor Input Signals

RGB Video Input Signals The red, green, and blue input signals are at test points 7A, 7B, and 7C of the cathode-ray tube (CRT) PCB. Wave shape and polarity are as shown in Figure 2.

Sync Signal The composite synchronization (sync) signal of horizontal and vertical pulses is at pin 10 of IC401 (on the Main PCB). Sync amplitude is 2.4 volts peak-to-peak with a negative polarity. Pulse width is 3–5 μ s horizontally and over 190.5 μ s vertically.



Figure 2 RGB Video Input Signals

G. Pattern Size

You should be able to reproduce the patterns as shown in Figure 3.

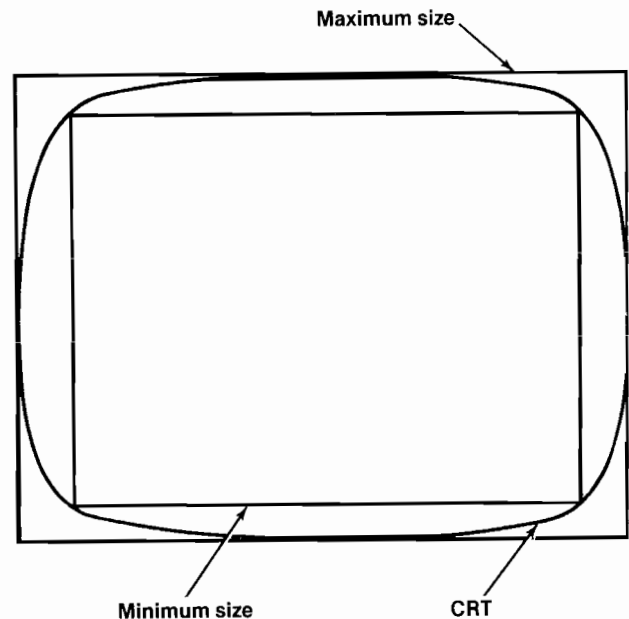

Figure 3 Display Pattern Sizes

3 Control Adjustments

WARNING

Remember to observe the precautions regarding high voltages when making adjustments to this display!

NOTE

Before making any of the following adjustments, turn on the display and allow it to warm up for at least 5 minutes.

A. Brightness

The SCREEN control, VR707, should be adjusted if the picture image is either too bright or too dark. Figure 4 shows the location of the SCREEN control on the CRT printed-circuit board (PCB).

1. Place the game in the attract or play mode.
2. Using the SCREEN control shown in Figure 4, adjust the display for a pleasing level of brightness.

NOTE

Too high a brightness level will cause the retrace lines to show; too low a level will cause the entire screen to be dark and obscure.

B. Horizontal Hold

The H-HOLD control should be adjusted if the picture is tearing sideways across the screen. Figure 5 shows the location of H-HOLD control VR501 on the Main PCB. Adjust this control until the black lines no longer slant sideways and you obtain a normal screen image.

C. Vertical Hold

The V-HOLD control should be adjusted if the picture drifts straight up or down on the screen. Figure 5 shows the location of V-HOLD control VR402 on the Main PCB. Adjust this control until the picture no longer drifts up or down on the screen.

D. Horizontal Positioning

The H-CENTER control should be adjusted if the picture is not centered across the screen, as indicated by a black area at either the left or the right edge of the

screen. Figure 5 shows the location of H-CENTER control VR502 on the Main PCB. Adjust this control until you obtain a normal screen image.

E. Vertical Positioning

The V-CENTER control should be adjusted if the picture is not vertically centered on the screen. Figure 5 shows the location of the V-CENTER control VR403 on the Main PCB. Adjust this control until you obtain a normal screen image.

F. Horizontal Size

The H-WIDTH coil should be adjusted if the screen raster is either too wide or narrow. Figure 5 shows the location of H-WIDTH control L507 on the Main PCB. Adjust the H-WIDTH control as follows:

1. Set the game for the self-test diagnostic pattern that displays the convergence grid and dots. (Refer to the game manual for detailed procedures on selecting the self-test patterns.)
2. Use only a non-metallic Allen wrench (commonly called a "tweaking tool") to adjust the H-WIDTH coil until the right and left grid lines run along the edges of the screen. These grid lines should not be positioned off the screen, which would indicate overscanning.

G. Vertical Size

The V-SIZE control should be adjusted if the screen image is either not filling the screen vertically, or if it is overscanning the screen vertically. Figure 5 shows the location of V-SIZE control VR401 on the Main PCB. Adjust the V-SIZE control as follows:

1. Set the game for the self-test diagnostic pattern that displays the convergence grid and dots. (Refer to the game manual for detailed procedures on selecting the self-test patterns.)
2. Slowly adjust V-SIZE control VR401 until the top and bottom grid lines are along the top and bottom edges of the screen. These grid lines should not disappear off the edges of the screen, which would indicate overscanning.

H. Focus

The FOCUS control should be adjusted if the CRT screen image is not sharply defined. The FOCUS control VR601 is mounted at the rear corner of the Main PCB, as shown in Figure 5. Turn this control until you get optimum screen sharpness.

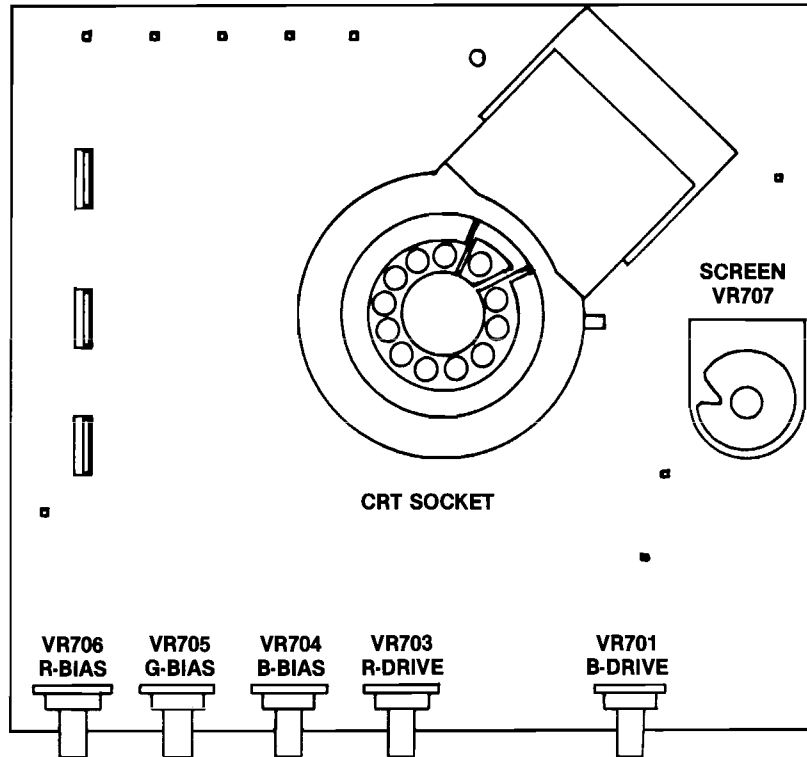

Figure 4 Adjustable Controls on CRT PCB

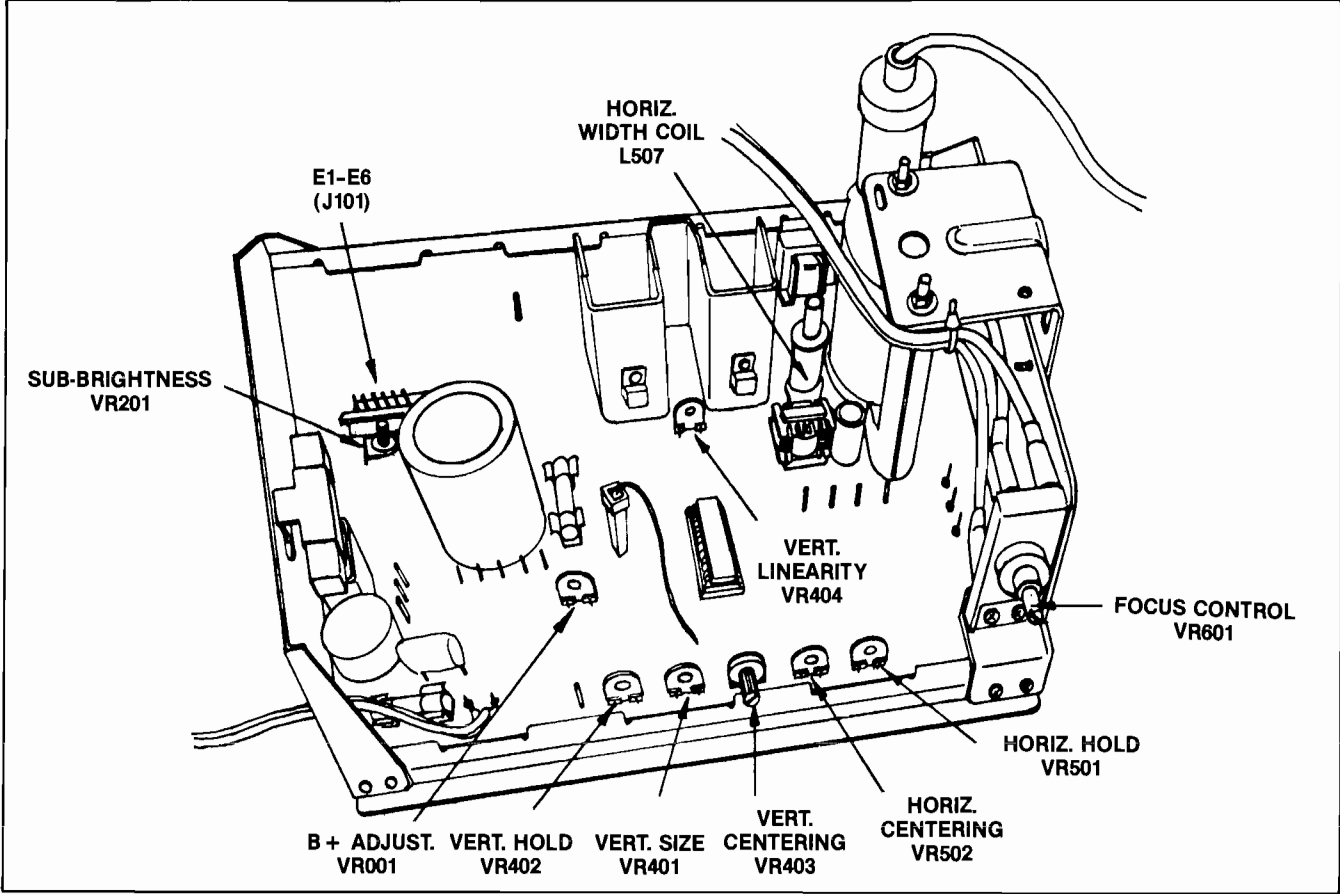

Figure 5 Adjustable Controls and Test Points on Main PCB

4 Signal Test Points

For illustrations of 22 waveforms, see Appendix A in this manual.

A. RGB Signals

The red, green, and blue signals can be checked at the input connector from the game. This connector is on the Main PCB at connector E1–E6. The red, green, and blue signals are on the pins labeled E1, E2, and E3 respectively (*see Figure 5 of this manual*).

You may also test for the presence of these three signals at pins 7A, 7B, and 7C near the edge of the CRT PCB. The waveforms of the red, green, and blue input signals are illustrated in Figure 2.

B. Sync Signal

The negative composite synchronization (sync) signal can be checked at the same connector E1–E6 on the Main PCB. Pin E5 receives the sync signal from the game harness. You may also test for the presence of this sync signal at pin 10 of IC401.

The amplitude is 2.4 V peak-to-peak with a negative polarity at pin 10 of IC401. The amplitude is 5 V peak-to-peak at pin E5. Pulse width for the horizontal sync component is 3 to 5 μs ; pulse width for the vertical sync component is more than 190.5 μs .

5 Details of Operation

A basic block diagram of the circuitry within this display is shown in Figure 6. Refer to this figure and the schematic diagram given in Figure 7 throughout the following discussion. In addition, refer to Appendix A for illustrations of 22 waveforms.

A. Sync Separator

The synchronization (sync) signal at J101, pin 2 or E5 of the 6-pin connector, is a negative composite signal from the game circuitry. This signal contains both the vertical and horizontal synchronization pulses for the display. The sync signal is applied through R508 to the sync separator at pin 10 of IC401.

B. Vertical and Horizontal Amplifiers

The composite video signal from the sync separator at pin 8 of IC401 is developed into the vertical deflection signal. This signal is passed through integrator R410-C404-C403 to the input of the vertical oscillator (pin 7 of IC401). V-HOLD control VR402 sets the DC operating level for the vertical oscillator. The output signal from the vertical oscillator (pin 4 of IC401) is modified with the vertical size information from V-SIZE VR407 and V-LINEAR VR404 and then applied to the Vertical Drive Amplifier at pin 2 of IC401. Final amplification for the vertical deflection signal is provided by Q402-Q403. From here the signal is applied to the deflection yoke of the CRT.

The horizontal deflection signal is also developed from the output signal of the sync separator. This signal is applied to the phase detector within IC401. After processing, the output signal from the phase detector (pin 12 of IC401) is applied across R526 to the horizontal oscillator at pin 13 of IC401. H-HOLD control VR501 sets the DC operating level for the horizontal oscillator. The output signal from the horizontal oscillator is applied through the horizontal output amplifier of IC401 to pin 15 of IC401. This signal is then applied across R509 to the base of horizontal drive transistor Q501, which provides drive to the primary of transformer T501. The horizontal signal is coupled into the secondary of T501 and applied across divider network R523-R524 and coils L501-L502 to the base of Q902. After final amplification by Q902, the horizontal deflection signal is applied to the deflection yoke of the CRT.

C. Z Amplifiers (Red, Green, and Blue)

NOTE

Because the red, green, and blue amplifiers are similar in operation, only the blue will be discussed here.

The blue intensity signal from the game circuitry is applied from pin 4 of J101 through R101 to the base of blue intensity buffer transistor Q101. From here the blue intensity signal is applied to pin 7A of the CRT PCB and then to the base of common-emitter transistor Q701. Variable resistor VR201, the SUB-BRIGHT control and DC level regulator Q201 set the DC operating level for the input transistors of all three Z amplifiers. Transistor Q202 is the blanking transistor for all three Z amplifiers. From the collector of Q701, the blue intensity signal is applied across R716 through pin 11 of the CRT base socket to the blue cathode gun. B-BIAS adjustment VR704 sets the cutoff characteristics of Q701. B-DRIVE adjustment VR701 sets the gain of Q701.

D. Blanking

The vertical deflection signal from the vertical drive output at pin 2 of IC401 also contains a negative-going vertical blanking signal. This negative-going blanking signal is applied through R205-C202-R209-D201-R210 to the base of Q202. During horizontal retrace, blanking transistor Q202 turns off, which turns off the blue intensity buffer (Q101).

The horizontal deflection signal is derived from the fly-back pulse at pin 6 of T902. During vertical retrace, blanking transistor Q202 turns off, which turns off the blue intensity buffer (Q101).

The vertical blanking pulses applied to the base of Q202 turns off buffers Q101-Q102-Q103 and blank the CRT during the horizontal retrace. The horizontal blanking pulses applied to the base of Q202 turn off buffers Q101-Q102-Q103 and blank the CRT during the vertical retrace.

E. High Voltage

The high-voltage signals are developed across flyback transformer T902. The horizontal deflection signal is applied across the primary of T902 to induce a 15.734-kHz signal into the secondary. The voltage induced into the secondary is stepped up to about +26 kV before it is applied to the anode of the CRT. The FOCUS and SCREEN adjustments are made in the secondary circuit of T902.

F. Line Input and Degaussing

Line voltage of 120 VAC is applied through AC fuse F001 and line-filter components L001-C007 to both the degaussing network and the rectifier. When cool, POS001 permits current to flow through the degaussing coil. However, after POS001 heats up, current is removed from the degaussing coil, rendering it inoperative.

The full-wave rectifier is composed of D007 through D010. This rectifier converts the AC input voltage into an unfiltered DC voltage. Capacitor C004 and ripple filter Q003 filter out AC ripple.

G. +115-Volt Regulated Supply

The +115-volt regulated supply provides operating power to circuitry throughout the display. The regulator for the +115-volt regulated supply is a feedback amplifier system that operates between ground and the rectified DC voltage. Current to the load is delivered by power regulator Q901. The supply voltage is established by the voltage drop across resistive-divider network R012-R013-VR001-R014 at the base of error amplifier Q002.

Feedback at the base of Q002 is coupled through regulator drive Q001 to Q901. Any variation in the supply output voltage (due to changing load requirements) causes Q002 to modify the biasing current of Q901. This nullifies the change in the supply output voltage.

DC fuse F002 provides circuit protection in the event of an overload or regulator malfunction.

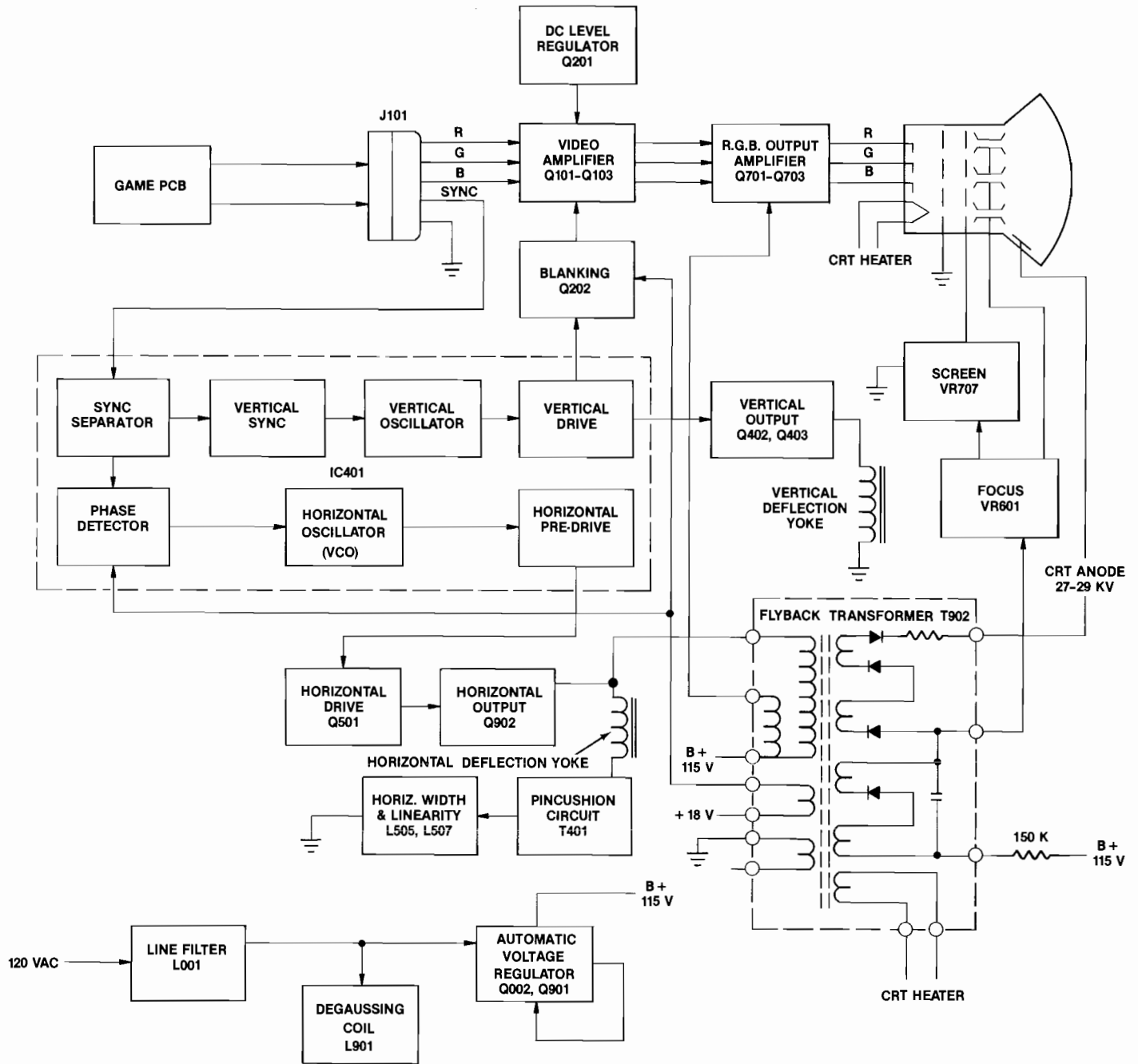
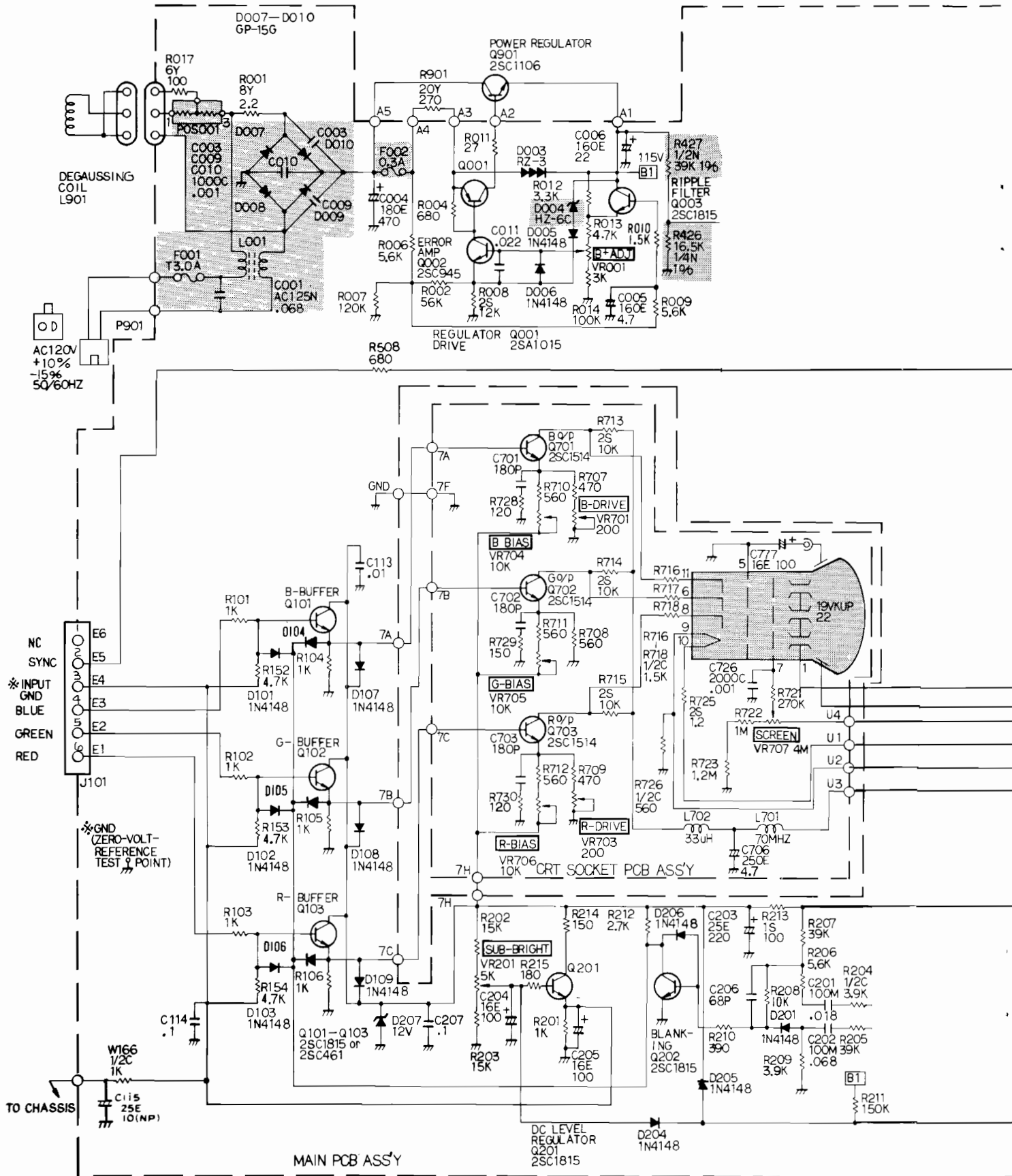
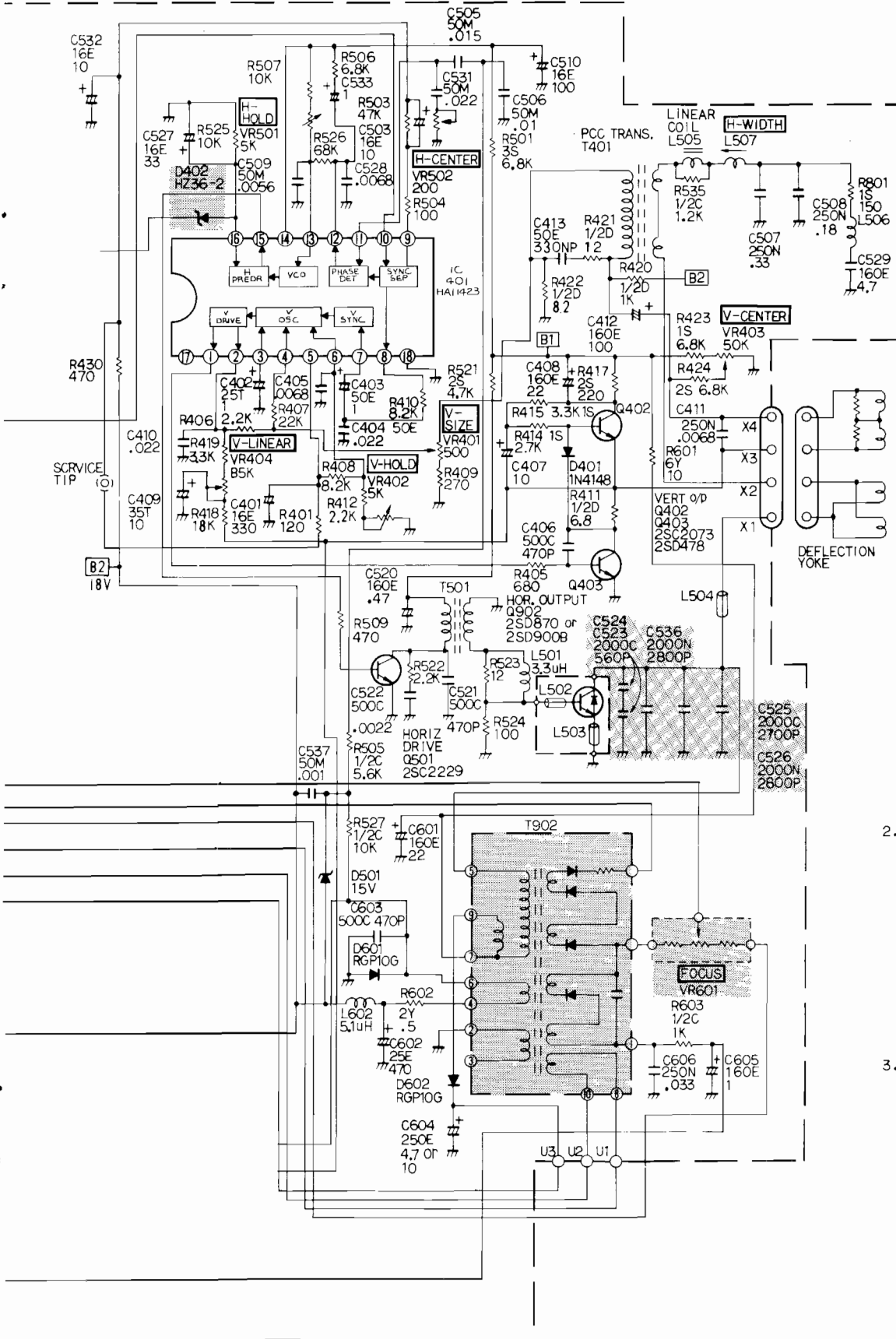

Figure 6 Block Diagram of the Disco 19-Inch Color Raster Display



- NOTE:**
1. The input GND (E4) is not at the same potential as the ground of the display. When making measurements and testing, take the GND test point as ground (0-volt reference).
 2. The frame, chassis and CRT coating are at the same potential as input GND (E4).



PRODUCT SAFETY NOTICE

The shaded areas of this schematic designate components whose values are of special significance to product safety. Should any component in the shaded areas need to be replaced, use only the value given in the parts list. Do not deviate from the resistance, wattage, and voltage values shown.

1. TRANSISTOR BASE INFORMATION.

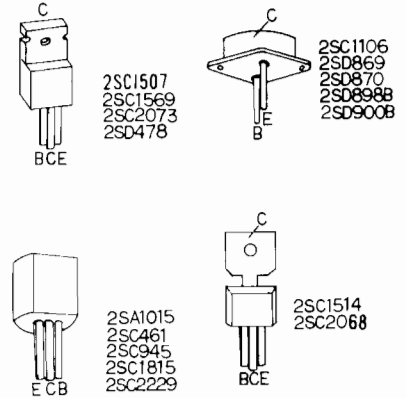

2. RESISTOR, CAPACITOR INFORMATION.

- RESISTOR-INFORMATION.
 - RESISTOR VALUE IN OHM. TYPE.
 - POWER RATING.
 - AS TO 1/4W D TYPE RESISTORS RESISTANCE VALUES ALONE ARE GIVEN.
- CAPACITOR-INFORMATION
 - EXPRESSED IN P WHEN THE UNIT IS PF, OTHERWISE OMITTED. TYPE.
 - RATING VOLTAGE (THE UNIT "V" OR "WV" IS OMITTED.) IS ONLY GIVEN.

- 3. RESISTOR TYPE**
- D: FIXED CARBON FILM RESISTOR.
 - S: FIXED METAL OXIDE FILM RESISTOR.
 - N: FIXED METAL FILM RESISTOR.
 - Y: FIXED WIRE WOUND FIXED RESISTOR.
 - C: FIXED CARBON COMPOSITION RESISTOR.

- CAPACITOR TYPE**
- C: FIXED CERAMIC CAPACITOR.
 - E: ALUMINUM ELECTROLYTIC CAPACITOR.
 - M: POLYESTER FILM CAPACITOR.
 - N: POLYPROPYLENE FILM CAPACITOR.
 - T: TANTALUM CAPACITOR.
 - (NP): NON-POLAR ALUMINUM ELECTROLYTIC CAPACITOR.

Figure 7 Disco Display Schematic Diagram

6 Repair

WARNING

Before removing or installing any component of this display, always disconnect the power source! Observe the precautions regarding high voltages and cathode-ray tube handling when servicing this display.

Tools required to replace these assemblies: ¼-inch hex socket wrench, 10-mm hex socket wrench (or an open wrench or pliers), Phillips-head screwdriver, and a soldering iron.

A. Cathode-Ray Tube Replacement

NOTE

You must readjust the brightness and perform the purity and convergence adjustment procedures whenever the cathode-ray tube is replaced.

1. Disconnect the 6-pin video-signal connector from the Main printed-circuit board (PCB). Disconnect the 2-pin power connector in the harness near the display.
2. Remove the Disco display assembly from the game as described in the game manual.
3. Discharge the high voltage from the cathode-ray tube (CRT) as follows:
 - a. Attach one end of a large, well-insulated, 18-gauge jumper wire to ground.
 - b. Momentarily touch the free end of the grounded jumper to the anode by sliding it under the anode cap.
 - c. Wait two minutes.
 - d. Discharge the anode again.
 - e. **Carefully** remove the large high-voltage anode connector from the CRT.
4. Unplug the CRT PCB from the rear of the cathode-ray tube.
5. Unplug the 4-wire connector attaching the yoke wires to the Main PCB.
6. Use a 10-mm hex socket wrench to remove the four screws holding the CRT to the steel chassis.

7. **Carefully** remove the CRT by easing it out the front of the chassis.
8. Place the cathode-ray tube on a soft mat in a protected location.
9. To install a CRT, reverse the order of this procedure.

B. Yoke Replacement

NOTE

You must reconverge the picture and readjust the color purity whenever the yoke is replaced.

1. Disconnect the 6-pin video-signal connector from the Main PCB.
2. Remove the Disco display assembly from the game as described in the game manual.
3. Discharge the high voltage from the CRT using the procedure given in step 3 under *A. Cathode-Ray Tube Replacement*.
4. Unplug the CRT PCB from the neck pins of the CRT.
5. Remove the cloth tapes securing the three rubber wedges beneath the yoke collar.
6. Use a thin knife or a single-edged razor blade to carefully loosen the three rubber wedges from the CRT surface.
7. Use a Phillips-head screwdriver and your fingers to loosen the screws that secure the two neck clamps around the CRT.
8. Slide the magnet assembly and the yoke assembly off the end of the CRT.
9. To replace a yoke assembly, reverse the order of this procedure.

C. Flyback Transformer Replacement

1. Disconnect the 6-pin video-signal connector from the Main PCB.
2. Remove the Disco display assembly from the cabinet as described in the game manual.
3. Discharge the high voltage from the CRT as described in step 3 under *A. Cathode-Ray Tube Replacement*. Unplug the red anode wire from the CRT.

4. Unplug both 4-pin connectors on the Main PCB.
5. Remove the Main PCB from the display chassis by removing the two screws at the rear edge of the PCB.
6. Slide back the rubber cap on the beige wire connected to the focus assembly above the Main PCB. Note: You may have to use a flat tool (such as a thin screwdriver) to loosen the rubber cap, since the cap is held by glue inside. Unsolder this wire from the focus assembly.
7. Using a ¼-inch hex socket wrench, remove the two screws that secure the flyback transformer to the metal bracket. Then remove the four screws on the side of this bracket. Tilt the bracket away from the flyback transformer.
8. Unsolder the ten transformer connections on the bottom side of the Main PCB. Lift the transformer off the Main PCB.
9. Replace the transformer by reversing this procedure. Be sure to check the picture for sharpness after the transformer is replaced. If appropriate, readjust the FOCUS.

D. CRT PCB Replacement

1. Disconnect the 6-pin video-signal connector from the Main PCB. Disconnect the 2-pin power connector in the harness near the display.
2. Remove the Disco display assembly from the cabinet as described in the game manual.
3. Discharge the high voltage from the CRT as described in step 3 under *A. Cathode-Ray Tube Replacement*.
4. Unplug the 1-pin connector (ground) on the CRT PCB. Gently pull the CRT PCB from the neck pins of the CRT.
5. Remove the twist-and-tie connectors on the edges of the CRT PCB.
6. Unsolder the 9 wires connected to this PCB. Pry off the white square cap on the CRT PCB.
7. Unsolder the large black wire that is attached to the white connector.
8. To replace the CRT PCB, reverse the order of this procedure.

E. Main PCB Replacement

1. Disconnect the 6-pin video-signal connector from the Video Amplifier PCB. Disconnect the 2-pin power connector in the harness near the display.
2. Remove the Disco display assembly from the cabinet as described in the game manual.
3. Discharge the high voltage from the CRT as described in step 3 under *A. Cathode-Ray Tube Replacement*. Unplug the red anode wire from the CRT.
4. Gently pull the CRT PCB from the neck pins of the CRT.
5. Unplug both 4-pin connectors on the Main PCB.
6. Use a Phillips-head screwdriver to remove the two screws securing the Main PCB to the chassis.
7. Unsolder all 18 wires on the Main PCB that would prevent the PCB from being removed from its metal frame.
8. Remove the four screws at the left front and rear edges of the Main PCB. Remove the two hex nuts on top of the flyback transformer.
9. Slide back the rubber cap on the beige wire connected to the focus assembly above the Main PCB. Note: You may have to use a flat tool (such as a thin screwdriver) to loosen the rubber cap, since the cap is held by glue inside. Unsolder this wire from the focus assembly.
10. Gently pull the Main PCB out the left side of its metal frame.
11. To replace the Main PCB, reverse the order of this procedure.

7 Adjustments and Testing

WARNING
Remember to observe the precautions regarding high voltages when making adjustments on this display!

B. Purity Adjustments

NOTE
The convergence adjustments must be performed after completion of the purity adjustments.

Before adjusting the display, remove the display assembly from the game using the procedure given in the game manual. Leave connected all cables between the display assembly and other parts of the game.

A. Video B + Adjustment

1. Set SCREEN control VR707 on the CRT PCB for maximum brightness. Refer to Figure 4 for the location of the SCREEN control.
2. Remove power from the display.
3. Set a DC voltmeter to the 0-volt to +150-volt range.
4. Connect the plus lead of the voltmeter to test point A1, which is shown in Figure 8.
5. Apply power to the display.
6. Adjust VR001 on the Main PCB, shown in Figure 8, for a voltmeter reading of +115 volts.
7. Return SCREEN control VR707 to its normal setting.

1. Set up the display for the purity adjustments as follows:
 - a. Remove power from the display.
 - b. Loosen the screws that are used to tighten the deflection yoke and convergence-magnet assembly clamps to the neck of the cathode-ray tube (CRT).
 - c. Remove any glue that may be holding the purity magnets in place.
 - d. Remove the cloth tapes securing the three rubber wedges beneath the deflection yoke of the CRT. Use a razor blade or thin knife to loosen any glue holding the rubber wedges to the CRT surface. Remove these wedges.
 - e. Position the display so that the CRT faces either north or south. Degauss the CRT with a hand-held degaussing coil.
 - f. Apply power to the display.

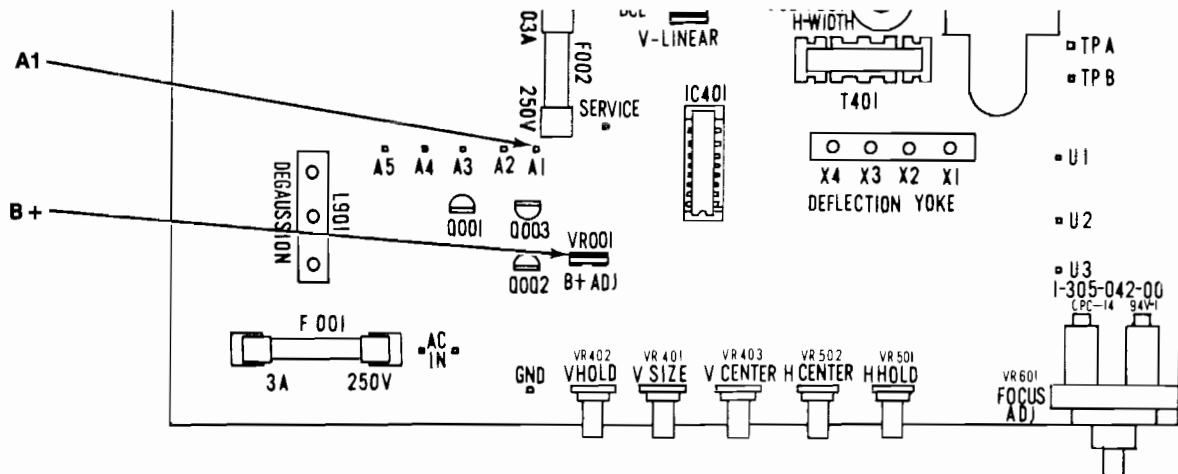

Figure 8 Locations of Video B + Adjustment VR001 and Test Point A1

2. Position the convergence-magnet assembly so that the purity rings shown in Figure 9 are positioned directly over the gap in the cathode-ray tube gun assembly. This is about two inches forward from the start of the neck glass.
3. Secure the convergence-magnet assembly in position by tightening the neck-clamp mounting screw.
4. Set the game to display the self-test diagnostic pattern that shows a vertical and horizontal crosshatch with all three colors. This may appear as a white crosshatch pattern on the screen. (Refer to the Self-Test Procedure in the game manual for the details on selecting self-test diagnostic patterns.)
5. Preset the convergence magnets to superimpose the red, blue, and green lines at the center of the screen.
6. Set the game so it displays only the green crosshatch diagnostic pattern. If the game does not produce a green-only crosshatch pattern, turn off R-DRIVE VR703 and B-DRIVE VR701 of the display CRT PCB. Refer to Figure 10 for the locations of the Drive controls.
7. Slide the deflection yoke toward the magnet assembly to produce a vertical green band within the center of the crosshatch pattern.
8. Adjust the purity rings of the magnet assembly shown in Figure 9 to center the green band horizontally on the face of the CRT.

NOTE

The purity rings must only affect the horizontal centering of the display. If they have a vertical or a diagonal centering effect, rotate the entire magnet assembly so that the purity rings affect *only* the horizontal centering.

9. Slowly slide the deflection yoke forward until the crosshatch pattern is all green. Tighten the yoke-mounting screw.
10. Set the game to display the self-test diagnostic pattern that shows a crosshatch pattern of all three colors. If you turned off the R-DRIVE and B-DRIVE controls of the display, return them to their normal settings.
11. Check the display for good overall purity.
12. Perform the convergence adjustments.

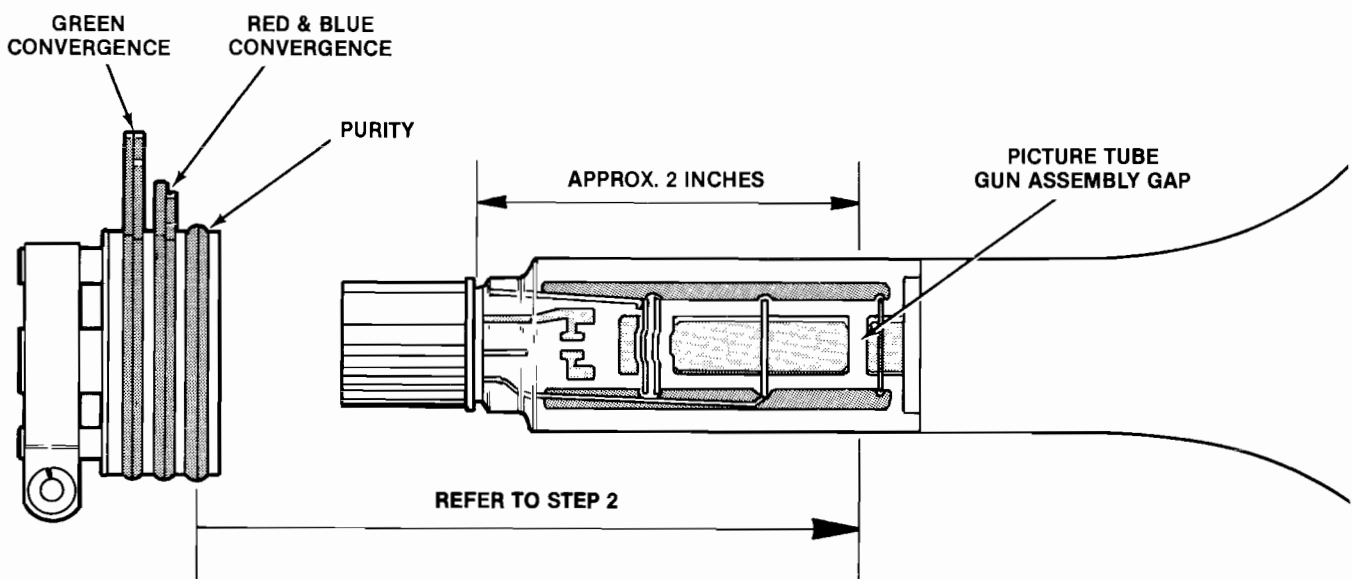

Figure 9 Purity and Convergence Adjustments

C. Convergence Adjustments

NOTE

If the purity adjustments have been performed, you must also perform the entire convergence adjustments procedure.

1. Adjust for static convergence, which aligns the registration of all three colors over the entire screen area, as follows:
 - a. Set the game to display the self-test diagnostic pattern that shows a crosshatch of all three colors. This may appear as a white crosshatch pattern. (Refer to the Self-Test Procedure in the game manual for the details on selecting self-test diagnostic patterns.)
 - b. Adjust the angle of the tabs of the red and blue convergence magnets to superimpose the red and blue vertical lines in the center of the screen area. This will produce magenta vertical lines at screen center. These magnets are shown in Figure 9.

NOTE

Do not attempt to adjust the convergence of the outer areas of the screen at this time.

- c. Keeping their angles the same, rotate both tabs of these magnets to superimpose the red horizontal lines on the blue horizontal lines in the center of the screen area. This produces magenta horizontal lines at screen center.
 - d. Adjust the angle between the tabs of the green convergence magnets to superimpose the green vertical lines on the magenta vertical lines already converged in the center of the screen.
 - e. Keeping the tab angles the same, rotate these rings to superimpose the green horizontal lines on the magenta horizontal lines already converged in the center of the screen.
2. Adjust for dynamic convergence, which aligns the registration of all three colors at the outer areas of the screen, as follows:
 - a. If not already done as part of the purity adjustments, loosen the screw securing the deflection yoke assembly to the neck of the cathode-ray tube. Remove the cloth tapes holding the three rubber wedges beneath the

yoke. Use a razor blade or thin knife to loosen any glue securing the three rubber wedges to the CRT. Remove these wedges.

- b. Tilt the deflection yoke in a vertical direction to superimpose the red horizontal lines on the blue and green horizontal lines at the 3 o'clock and 9 o'clock positions of the screen. This produces white horizontal lines.
 - c. While maintaining the vertical position of the yoke, tilt it in a horizontal direction to superimpose the red crosshatch on the blue and green crosshatch patterns at the 6 o'clock and 12 o'clock positions of the screen. This produces a white crosshatch pattern.
 - d. Install the three rubber wedges firmly beneath the yoke collar to hold the yoke in position. Recheck the convergence of the display. If necessary, repeat parts b and c of this step and the static convergence adjustments of step 1.
3. Secure the rings of the convergence-magnet assembly and the rubber yoke wedges with white glue. Replace the cloth tapes over the rubber wedges.
4. Tighten the deflection-yoke mounting screw.

D. Tracking Adjustments

1. Remove power from both the game and the display.
2. Unplug the 6-pin video-signal connector, which is wired to the Main PCB.
3. On the CRT PCB, set the R-DRIVE, B-DRIVE, and the R-, G-, and B-BIAS controls to their mechanical centers. Turn the SCREEN control VR707 to minimum (fully counterclockwise). Figure 10 shows the location of all the tracking adjustments on the CRT PCB.
4. On the Main PCB, set the SUB-BRIGHTNESS control VR201 to its mechanical center.
5. Apply power to the display.
6. Slowly adjust SCREEN control VR707 until the CRT screen shows the first hint of color. Do not adjust the bias control for the color which first appeared on the CRT screen. Slowly adjust the bias controls for the other two colors until the CRT screen is a faint grey. Now reduce the SCREEN setting until the color just disappears.
7. Remove power from the display. Reconnect the 6-pin video-signal connector between the game and the display.
8. Reapply power to both the game and the display.
9. Set the game to display the self-test diagnostic pattern that shows a white crosshatch. (Refer to the Self-Test Procedure in the game manual for detailed procedures on selecting the self-test diagnostic patterns.)
10. Adjust R-DRIVE and B-DRIVE for a neutral white crosshatch pattern. If necessary, readjust the SCREEN control on the CRT PCB for a proper black level.

WARNING
Be careful of high voltage present on this PCB.

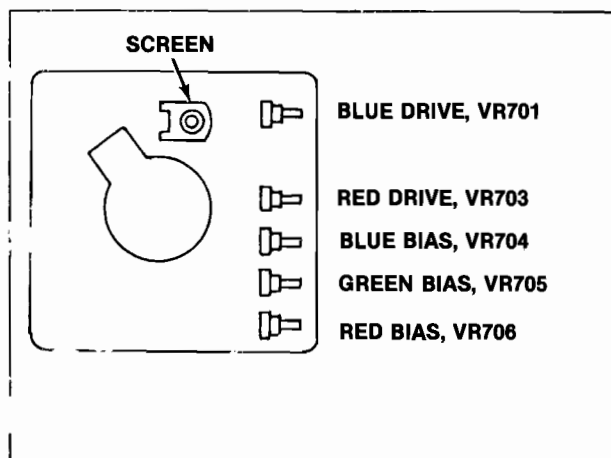

Figure 10 Locations of Tracking Adjustments on the CRT PCB

8 Illustrated Parts Lists

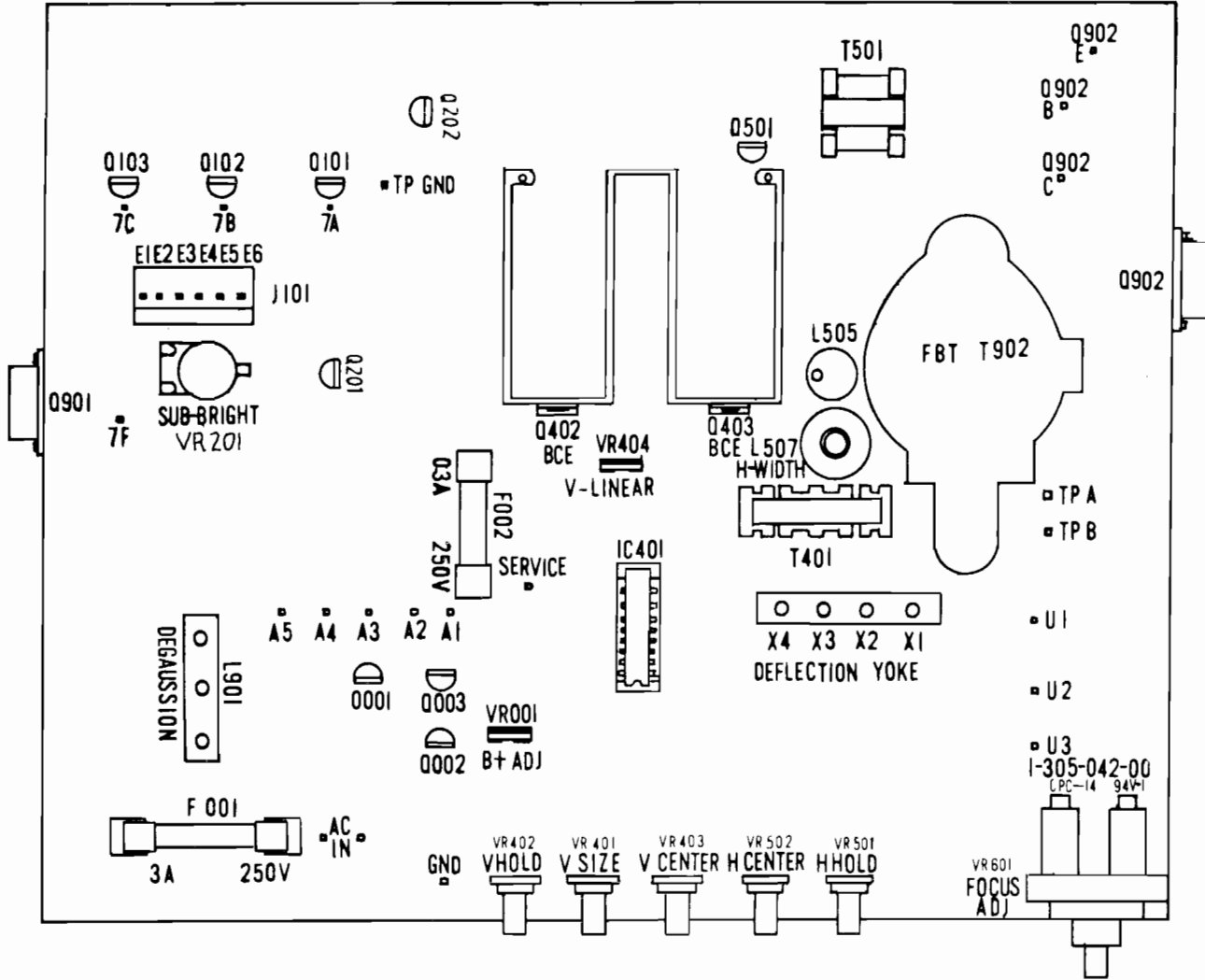
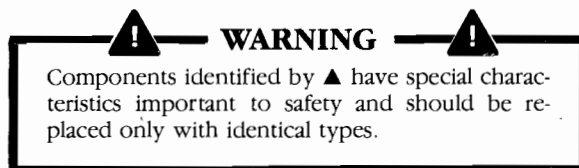

Figure 11 Main PCB Assembly
99-170161 A

Main PCB Assembly, continued Parts List



Designator	Description	Part No.
Capacitors		
C001	▲ 0.068 μ F, \pm 10%, AC125V, Poly-Film Capacitor ▲ <i>Acceptable substitute is 0.068 μF, \pm 20 %, AC125V, Poly-Film Capacitor, part no. 99-170111</i>	99-170110
C003	1000 pF, \pm 10%, 1KV, Ceramic Capacitor	99-170096
C004	470 μ F, 180V, Electrolytic Capacitor	99-170089
C005	4.7 μ F, 160V, Electrolytic Capacitor	99-170086
C006	22 μ F, 160V, Electrolytic Capacitor	99-170087
C009	1000 pF, \pm 10%, 1KV, Ceramic Capacitor	99-170096
C010	1000 pF, \pm 10%, 1KV, Ceramic Capacitor	99-170096
C011	0.022 μ F, \pm 5%, 50V, Poly-Film Capacitor	99-170108
C113	0.01 μ F, 50V, Ceramic Capacitor	99-170016
C114	0.1 μ F, \pm 10%, 50V, Ceramic Capacitor	99-170092
C201	0.018 μ F, \pm 10%, 100V, Poly-Film Capacitor	99-170100
C202	0.068 μ F, \pm 10%, 100V, Poly-Film Capacitor	99-170101
C203	220 μ F, 25V, Electrolytic Capacitor	99-170079
C204	100 μ F, 16V, Electrolytic Capacitor	99-170077
C205	100 μ F, 16V, Electrolytic Capacitor	99-170077
C206	68 pF, \pm 5%, 50V, Ceramic Capacitor	99-170093
C207	0.1 μ F, \pm 10%, 50V, Ceramic Capacitor	99-170092
C208	1 μ F, 160V, Electrolytic Capacitor	99-170085
C401	330 μ F, 16V, Electrolytic Capacitor	99-170078
C402	1 μ F, \pm 10%, 15V, Tantalum Capacitor <i>Acceptable substitute is 1 μF, \pm 10 %, 25V, ALSICON Capacitor, part no. 99-170113</i>	99-170112
C403	1 μ F, 50V, Electrolytic Capacitor	99-170081
C404	0.022 μ F, \pm 5%, 50V, Poly-Film Capacitor	99-170108
C405	0.0068 μ F, \pm 5%, 50V, Poly-Film Capacitor	99-170106
C406	470 pF, \pm 10%, 500V, Ceramic Capacitor	99-170094
C407	10 μ F, 50V, Electrolytic Capacitor	99-170082
C408	22 μ F, 160V, Electrolytic Capacitor	99-170087
C409	10 μ F, \pm 10%, 35V, Tantalum Capacitor	99-170114
C410	0.022 μ F, \pm 5%, 50V, Poly-Film Capacitor	99-170108
C411	0.0068 μ F, \pm 10%, 200V, Poly-Film Capacitor	99-170102
C412	100 μ F, 160V, Electrolytic Capacitor	99-170088
C413	330 μ F, 50V, Electrolytic Non-Polar Capacitor	99-170083
C503	10 μ F, 16V, Electrolytic Capacitor	99-170075
C505	0.015 μ F, \pm 5%, 50V, Poly-Film Capacitor	99-170107
C506	0.01 μ F, \pm 5%, 50V, Poly-Film Capacitor	99-170109

Continued on next page

Main PCB Assembly, continued Parts List

Designator	Description	Part No.
C507	0.33 μ F, \pm 5%, 250V, Poly-Film Capacitor	99-170104
C508	0.18 μ F, \pm 5%, 250V, Poly-Film Capacitor	99-170103
C509	0.0056 μ F, \pm 5%, 50V, Poly-Film Capacitor	99-170098
C510	100 μ F, 16V, Electrolytic Capacitor	99-170077
C520	0.47 μ F, 160V, Electrolytic Capacitor	99-170084
C521	470 pF, \pm 10%, 500V, Ceramic Capacitor	99-170094
C522	2200 pF, \pm 10%, 500V, Ceramic Capacitor	99-170095
C523	▲ 560 pF, \pm 10%, 2KV, Ceramic Capacitor	99-170097
C524	▲ 560 pF, \pm 10%, 2KV, Ceramic Capacitor	99-170097
C525	▲ 2700 pF, \pm 10%, 2KV, Ceramic Capacitor	99-170098
C526	2800 pF, \pm 5%, 2KV, Poly-Film Capacitor	99-170105
C527	33 μ F, 16V, Electrolytic Capacitor	99-170076
C528	0.0068 μ F, \pm 5%, 50V, Poly-Film Capacitor	99-170106
C529	4.7 μ F, 160V, Electrolytic Capacitor	99-170086
C531	0.022 μ F, \pm 5%, 50V, Poly-Film Capacitor	99-170108
C532	10 μ F, 16V, Electrolytic Capacitor	99-170075
C533	1 μ F, 50V, Electrolytic Capacitor	99-170081
C536	2800 pF, \pm 5%, 2KV, Poly-Film Capacitor	99-170105
C537	0.001 μ F, \pm 5%, 50V, Poly-Film Capacitor	99-170115
C601	22 μ F, 160V, Electrolytic Capacitor	99-170087
C602	470 μ F, 25V, Electrolytic Capacitor	99-170080
C603	470 pF, \pm 10%, 500V, Ceramic Capacitor	99-170094
C604	4.7 μ F, 250V, Electrolytic Capacitor <i>Acceptable substitute is 10 μF, 250V, Electrolytic Capacitor, part no. 99-170091</i>	99-170090
C605	1 μ F, 160V, Electrolytic Capacitor	99-170085
C611	1 μ F, 50V, Electrolytic Capacitor	99-170081
Coils and Ferrite Lead Beads		
L001	▲ Line Filter	99-170139
L501	3.3 μ H Inductor	99-170140
L504	0.2 μ H Ferrite Bead	99-170141
L505	Linearity Coil	99-170143
L506	3.3 μ H, 75 MHz Series Resonant Frequency Choke	99-170145
L507	Horizontal Width Coil	99-170142
L602	5.1 μ H Filter Coil	99-170144
Connectors and Miscellaneous Hardware		
J101	6-Pin Base <i>Acceptable substitutes are part no. 99-170153 and 99-170154</i>	99-170155
P901	2-Pin Power Connector	99-170151
VR601	High-Voltage Bushing	99-170156
	CRT Ground Spring	99-170157
	1-Pin Connector Assembly	99-170149
	Plastic Wire Tie	99-170158
	GT Pin	99-170150
	Square Pin	99-170163
	3 x 8 Screw	99-170159
	1-Pin Connector	99-170152

Continued on next page

Main PCB Assembly, continued Parts List

<i>Designator</i>	<i>Description</i>	<i>Part No.</i>
Diodes		
D003	Type-RZ3 Diode	99-170124
D004	▲ Type-HZ6C Zener Diode	99-170129
D004	▲ Type-EQA01-06SB Zener Diode	99-170130
D005	Type-1S2473 Diode <i>Acceptable substitutes are: Type-1N4148 Diode, part no. 99-170125 and Type-1S1555 Diode, part no. 99-170126</i>	99-170127
D006	Type-1N4148 Diode <i>Acceptable substitute is Type-1S1555 Diode, part no. 99-170126</i>	99-170125
D006	Type-1S2473 Diode	99-170127
D007-D010	▲ Type-GP15G Diode	99-170123
D101-D109	Type-1S1555 Diode <i>Acceptable substitute is Type-1N4148 Diode, part no. 99-170125</i>	99-170126
D101-D109	Type-1S2473 Diode	99-170127
D201	Type-1N4148 Diode <i>Acceptable substitutes are Type-1S1555 Diode, part no. 99-170126, and Type-1S2473 Diode, part no. 99-170127</i>	99-170125
D204-D206	Type-1S1555 Diode <i>Acceptable substitutes are Type-1N4148 Diode, part no. 99-170125, and Type-1S2473 Diode, part no. 99-170127</i>	99-170126
D207	Type-BZX85C12 Zener Diode	99-170133
D402	▲ Type-HZ36-2 Zener Diode	99-170132
D501	Type-EQA01-15S Zener Diode	99-170131
D601	Type-RGP10G Diode	99-170128
D602	Type-RGP10G Diode	99-170128
Fuses and Fuse Holders		
(F001)	Fuse Holder	99-170165
F001	▲ Slow-Blow 3 A Fuse	99-170160
F002	▲ 0.3 A Fuse	99-170164
(F002)	Fuse Holder	99-170165
Integrated Circuits and Sockets		
(IC401)	20-Pin IC Socket	99-170162
IC401	Type-HA11423 Integrated Circuit	99-170117
Resistors		
POS001	Type-PTH451B02 Posistor	99-170058
R001	2.2 Ω , $\pm 5\%$, 8W, Wire-Wound Resistor	99-170057
R004	680 Ω , $\pm 5\%$, $\frac{1}{4}$ W, Carbon-Deposit Resistor	99-170011
R005	56 k Ω , $\pm 5\%$, $\frac{1}{4}$ W, Carbon-Deposit Resistor	99-170028
R006	5.6 k Ω , $\pm 5\%$, $\frac{1}{4}$ W, Carbon-Deposit Resistor	99-170019
R007	120 k Ω , $\pm 5\%$, $\frac{1}{4}$ W, Carbon-Deposit Resistor	99-170031
R008	12 k Ω , $\pm 5\%$, 2W, Metal-Oxide Resistor	99-170051
R009	5.6 k Ω , $\pm 5\%$, $\frac{1}{4}$ W, Carbon-Deposit Resistor	99-170019

Continued on next page

Main PCB Assembly, continued Parts List

<i>Designator</i>	<i>Description</i>	<i>Part No.</i>
R010	1.5 k Ω , \pm 5%, ¼ W, Carbon-Deposit Resistor	99-170013
R011	27 Ω , \pm 5%, ¼ W, Carbon-Deposit Resistor	99-170002
R012	3.3 k Ω , \pm 5%, ¼ W, Carbon-Deposit Resistor	99-170016
R013	4.7 k Ω , \pm 5%, ¼ W, Carbon-Deposit Resistor	99-170018
R014	100 k Ω , \pm 5%, ¼ W, Carbon-Deposit Resistor	99-170030
R017	100 Ω , \pm 5%, 6W, Wire-Wound Resistor	99-170056
R101-R106	1K Ω , \pm 5%, ¼ W, Carbon-Deposit Resistor	99-170012
R118	4.7 k Ω , \pm 5%, ¼ W, Carbon-Deposit Resistor	99-170018
R122	1K Ω , \pm 5%, ¼ W, Carbon-Deposit Resistor	99-170012
R152-R154	4.7 k Ω , \pm 5%, ¼ W, Carbon-Deposit Resistor	99-170018
R166	1 k Ω , \pm 10%, ½ W, Carbon-Composition Resistor	99-170037
R201	1K Ω , \pm 5%, ¼ W, Carbon-Deposit Resistor	99-170012
R202	15 k Ω , \pm 5%, ¼ W, Carbon-Deposit Resistor	99-170023
R203	15 k Ω , \pm 5%, ¼ W, Carbon-Deposit Resistor	99-170023
R204	3.9 k Ω , \pm 10%, ½ W, Carbon-Composition Resistor	99-170039
R205	39 k Ω , \pm 5%, ¼ W, Carbon-Deposit Resistor	99-170026
R206	5.6 k Ω , \pm 5%, ¼ W, Carbon-Deposit Resistor	99-170019
R207	39 k Ω , \pm 5%, ¼ W, Carbon-Deposit Resistor	99-170026
R209	3.9 k Ω , \pm 5%, ¼ W, Carbon-Deposit Resistor	99-170017
R210	390 Ω , \pm 5%, ¼ W, Carbon-Deposit Resistor	99-170009
R211	150 k Ω , \pm 5%, ¼ W, Carbon-Deposit Resistor	99-170032
R212	2.7 k Ω , \pm 5%, ¼ W, Carbon-Deposit Resistor	99-170015
R213	100 Ω , \pm 5%, 1W, Metal-Oxide Resistor	99-170044
R214	150 Ω , \pm 5%, ¼ W, Carbon-Deposit Resistor	99-170005
R215	180 Ω , \pm 5%, ¼ W, Carbon-Deposit Resistor	99-170006
R401	120 Ω , \pm 5%, ¼ W, Carbon-Deposit Resistor	99-170004
R405	680 Ω , \pm 5%, ¼ W, Carbon-Deposit Resistor	99-170011
R406	2.2 k Ω , \pm 5%, ¼ W, Carbon-Deposit Resistor	99-170014
R407	22 k Ω , \pm 5%, ¼ W, Carbon-Deposit Resistor	99-170025
R408	8.2 k Ω , \pm 5%, ¼ W, Carbon-Deposit Resistor	99-170021
R409	270 Ω , \pm 5%, ¼ W, Carbon-Deposit Resistor	99-170007
R410	8.2 k Ω , \pm 5%, ¼ W, Carbon-Deposit Resistor	99-170021
R411	6.8 Ω , \pm 5%, ½ W, Carbon-Deposit Resistor	99-170033
R412	2.2 k Ω , \pm 5%, ¼ W, Carbon-Deposit Resistor	99-170014
R414	2.7 k Ω , \pm 5%, 1W, Metal-Oxide Resistor	99-170046
R415	3.3 k Ω , \pm 5%, 1W, Metal-Oxide Resistor	99-170047
R417	220 Ω , \pm 5%, 2W, Wire-Wound Resistor	99-170054
R418	18 k Ω , \pm 5%, ¼ W, Carbon-Deposit Resistor	99-170024
R419	3.3 k Ω , \pm 5%, ¼ W, Carbon-Deposit Resistor	99-170016
R420	1 k Ω , \pm 5%, ½ W, Carbon-Deposit Resistor	99-170036
R421	12 Ω , \pm 5%, ½ W, Carbon-Deposit Resistor	99-170035
R422	8.2 Ω , \pm 5%, ½ W, Carbon-Deposit Resistor	99-170034
R423	6.8 k Ω , \pm 5%, 1W, Metal-Oxide Resistor	99-170048
R424	6.8 k Ω , \pm 5%, 2W, Metal-Oxide Resistor	99-170050

Continued on next page

Main PCB Assembly, continued Parts List

<i>Designator</i>	<i>Description</i>	<i>Part No.</i>
R426	▲ 16.5 k Ω , \pm 1%, ¼ W, Metal-Film Resistor	99-170042
R427	▲ 39 k Ω , \pm 1%, ½ W, Metal-Film Resistor	99-170043
R430	470 Ω , \pm 5%, ¼ W, Carbon-Deposit Resistor	99-170010
R501	6.8 k Ω , \pm 5%, 3W, Metal-Oxide Resistor	99-170052
R503	47 k Ω , \pm 5%, ¼ W, Carbon-Deposit Resistor	99-170027
R504	100 Ω , \pm 5%, ¼ W, Carbon-Deposit Resistor	99-170003
R505	5.6 k Ω , \pm 10%, ½ W, Carbon-Composition Resistor	99-170040
R506	6.8 k Ω , \pm 5%, ¼ W, Carbon-Deposit Resistor	99-170020
R507	10 k Ω , \pm 5%, ¼ W, Carbon-Deposit Resistor	99-170022
R508	680 Ω , \pm 5%, ¼ W, Carbon-Deposit Resistor	99-170011
R509	470 Ω , \pm 5%, ¼ W, Carbon-Deposit Resistor	99-170010
R521	4.7 k Ω , \pm 5%, 2W, Metal-Oxide Resistor	99-170049
R522	2.2 k Ω , \pm 5%, ¼ W, Carbon-Deposit Resistor	99-170014
R523	12 Ω , \pm 5%, ¼ W, Carbon-Deposit Resistor	99-170001
R524	100 Ω , \pm 5%, ¼ W, Carbon-Deposit Resistor	99-170003
R525	10 k Ω , \pm 5%, ¼ W, Carbon-Deposit Resistor	99-170022
R526	68 k Ω , \pm 5%, ¼ W, Carbon-Deposit Resistor	99-170029
R527	10 k Ω , \pm 10%, ½ W, Carbon-Composition Resistor	99-170041
R535	1.2 k Ω , \pm 10%, ½ W, Carbon-Composition Resistor	99-170038
R601	10 Ω , \pm 5%, 6W, Wire-Wound Resistor	99-170055
R602	0.5 Ω , \pm 5%, 2W, Wire-Wound Resistor	99-170053
R603	1 k Ω , \pm 5%, ½ W, Carbon-Deposit Resistor	99-170036
R801	150 Ω , \pm 5%, 1W, Metal-Oxide Resistor	99-170045
VR001	3 k Ω , B + Adjustment Variable Resistor	99-170073
VR201	5 k Ω , Sub-Bright Variable Resistor	99-170074
VR401	500 Ω , V-Size, Variable Resistor <i>Acceptable substitutes are part no. 99-170061 and 99-170059</i>	99-170060
VR402	5 k Ω , V-Hold, Variable Resistor <i>Acceptable substitutes are part no. 99-170064 and 99-170063</i>	99-170062
VR403	50 k Ω , V-Center, Variable Resistor <i>Acceptable substitutes are part no. 99-170067 and 99-170065</i>	99-170066
VR404	5 k Ω , V-Linearity, Variable Resistor <i>Acceptable substitute is part no. 99-170071</i>	99-170072
VR501	5 k Ω , H-Hold, Variable Resistor <i>Acceptable substitutes are part no. 99-170062 and 99-170064</i>	99-170063
VR502	200 Ω , H-Center, Variable Resistor <i>Acceptable substitutes are part no. 99-170070 and 99-170068</i>	99-170069
Transformers		
T401	Side Pincushion-Correction Transformer	99-170146
T501	Horizontal-Drive Transformer	99-170147
T902	▲ Flyback Transformer	99-170148

Continued on next page

Main PCB Assembly, continued Parts List

<i>Designator</i>	<i>Description</i>	<i>Part No.</i>
<i>Transistors</i>		
Q001	Type-2SA1015Y Transistor	99-170121
Q002	Type-2SC945P Transistor	99-170120
Q003	Type-2SC945P Transistor	99-170120
Q101-Q103	Type-2SC461C Transistor <i>Acceptable substitute is Type-2SC1815Y Transistor, part no. 99-170119</i>	99-170118
Q201	Type-2SC1213A C/D Transistor	99-170136
Q202	Type-BF422 Transistor <i>Acceptable substitute is Type-2SC454 Transistor, part no. 99-170137</i>	99-170138
Q402	Type-2SD478C/D Transistor <i>Acceptable substitute is Type-2SC2073T Transistor, part no. 99-170134</i>	99-170135
Q403	Type-2SC2073T Transistor <i>Acceptable substitute is Type-2SD478C/D Transistor, part no. 99-170135</i>	99-170134
Q501	Type-2SC2229M Transistor	99-170122

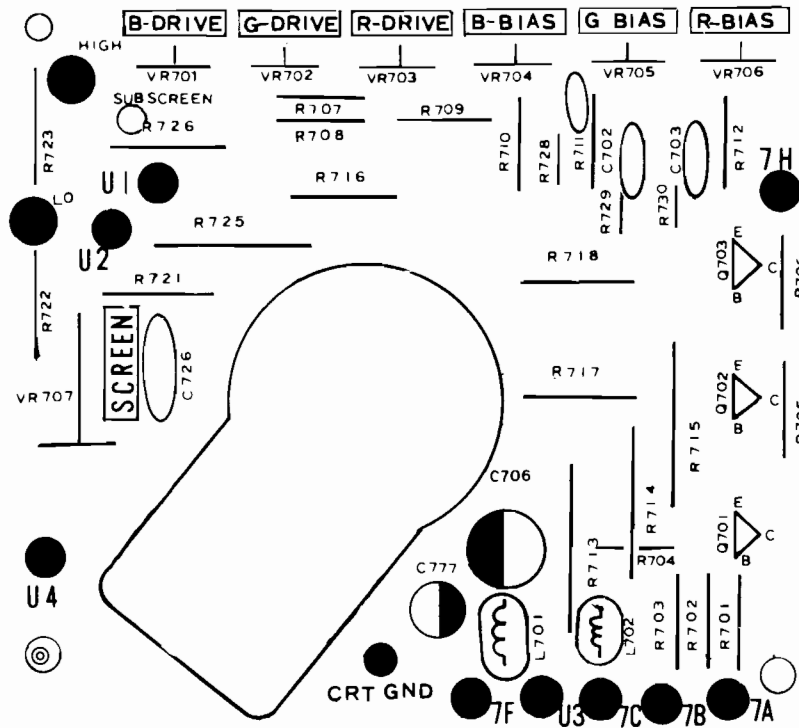

**Figure 12 CRT PCB Assembly
99-170190 A
Parts List**

▲ WARNING ▲

Components identified by ▲ have special characteristics important to safety and should be replaced only with identical types.

<i>Designator</i>	<i>Description</i>	<i>Part No.</i>
Capacitors		
C701-C703	180 pF, ± 5%, 50V, Ceramic Capacitor	99-170182
C706	4.7 μF, 250V, Electrolytic Capacitor	99-170090
C726	1000 pF, ± 10%, 2KV, Ceramic Capacitor	99-170183
C777	100 μF, 16V, Electrolytic Capacitor	99-170077

Continued on next page

CRT PCB Assembly, continued Parts List

<i>Designator</i>	<i>Description</i>	<i>Part No.</i>
Coils		
L701	70 MHz, Series Resonant Frequency Filter Coil	99-170188
L702	33 μ H Peaking Coil	99-170189
Resistors		
R707	470 Ω , $\pm 5\%$, $\frac{1}{4}$ W, Carbon-Deposit Resistor	99-170010
R708	560 Ω , $\pm 5\%$, $\frac{1}{4}$ W, Carbon-Deposit Resistor	99-170166
R709	470 Ω , $\pm 5\%$, $\frac{1}{4}$ W, Carbon-Deposit Resistor	99-170010
R710	560 Ω , $\pm 5\%$, $\frac{1}{4}$ W, Carbon-Deposit Resistor	99-170166
R711	560 Ω , $\pm 5\%$, $\frac{1}{4}$ W, Carbon-Deposit Resistor	99-170166
R712	560 Ω , $\pm 5\%$, $\frac{1}{4}$ W, Carbon-Deposit Resistor	99-170166
R713-R715	10 k Ω , $\pm 5\%$, 2W, Metal-Oxide Resistor	99-170172
R716-R718	1.5 k Ω , $\pm 10\%$, $\frac{1}{2}$ W, Carbon-Deposit Resistor	99-170170
R721	270 Ω , $\pm 10\%$, $\frac{1}{2}$ W, Carbon-Deposit Resistor	99-170171
R722	1 M Ω , $\pm 10\%$, $\frac{1}{4}$ W, Carbon-Deposit Resistor	99-170167
R723	1.2 M Ω , $\pm 10\%$, $\frac{1}{2}$ W, Carbon-Deposit Resistor	99-170168
R725	1.2 Ω , $\pm 5\%$, 2W, Metal-Oxide Resistor	99-170173
R726	560 Ω , $\pm 5\%$, $\frac{1}{2}$ W, Carbon-Deposit Resistor	99-170169
R728	120 Ω , $\pm 5\%$, $\frac{1}{4}$ W, Carbon-Deposit Resistor	99-170004
R729	150 Ω , $\pm 5\%$, $\frac{1}{4}$ W, Carbon-Deposit Resistor	99-170005
R730	120 Ω , $\pm 5\%$, $\frac{1}{4}$ W, Carbon-Deposit Resistor	99-170004
VR701	200 Ω Video-Drive Variable Resistor <i>Acceptable substitutes are part no. 99-170069 and 99-170179</i>	99-170180
VR703	200 Ω Video-Drive Variable Resistor <i>Acceptable substitutes are part no. 99-170069 and 99-170180</i>	99-170179
VR704	10 k Ω Blue-Bias Variable Resistor <i>Acceptable substitutes are part no. 99-170176 and 99-170178</i>	99-170174
VR705	10 k Ω Green-Bias Variable Resistor <i>Acceptable substitutes are part no. 99-170175 and 99-170177</i>	99-170174
VR706	10 k Ω Red-Bias Variable Resistor <i>Acceptable substitutes are part no. 99-170175 and 99-170176</i>	99-170174
VR707	4 M Ω Screen Variable Resistor	99-170181
Sockets		
	▲ CRT Socket	99-170191
Transistors		
Q701-Q703	Type-2SC1514 Transistor <i>Acceptable substitutes are Type-2SC1569 Transistor, part no. 99-170185; Type-2SC2068 Transistor, part no. 99-170186; and Type-2SC1057K/L Transistor, part no. 99-170187</i>	99-170184

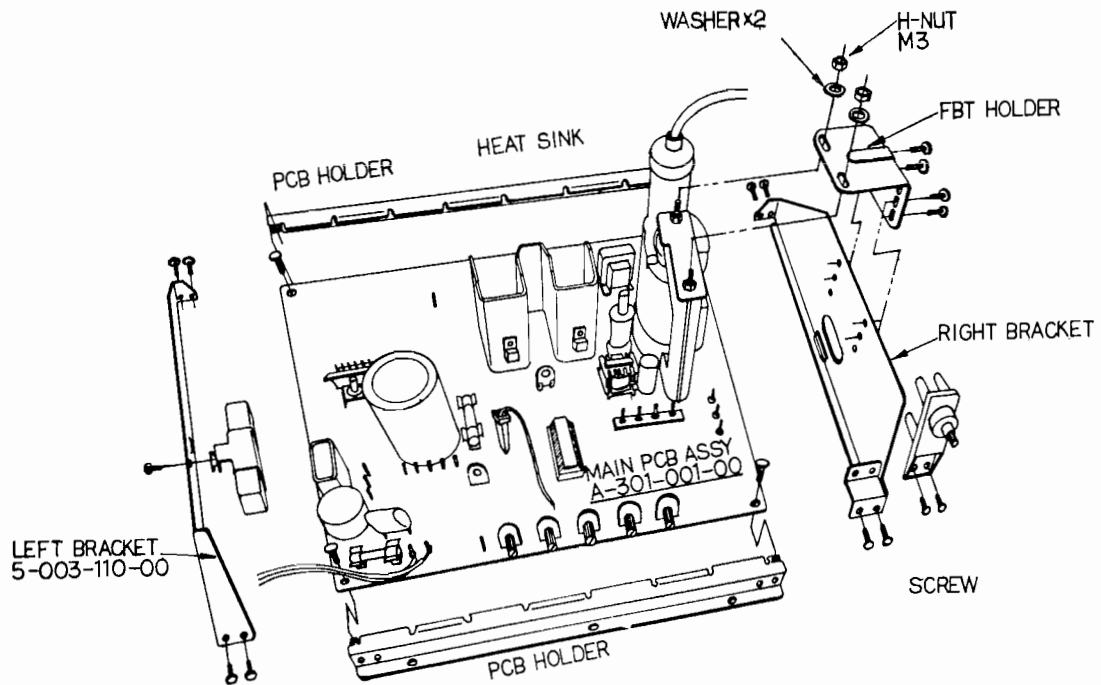
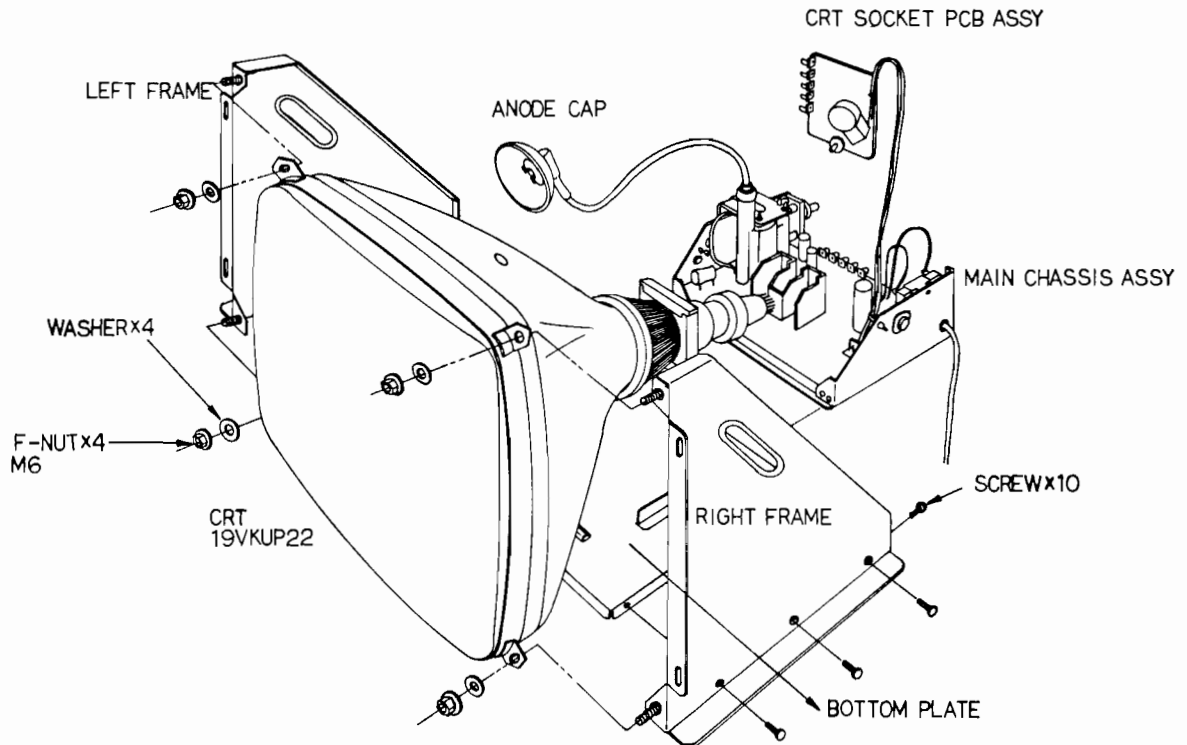

**Figure 13 Display Assembly
139003-1006 A**

Display Assembly Parts List

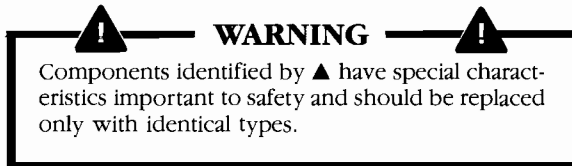

<i>Designator</i>	<i>Description</i>	<i>Part No.</i>
	Main Printed-Circuit Board— <i>see Figure 11</i>	99-170161
	CRT Printed-Circuit Board— <i>see Figure 12</i>	99-170190
Resistors		
R901	270 Ω , $\pm 10\%$, 20W, Power Resistor	99-170202
VR601	Type-MHF008-06 Focus Variable Resistor <i>Acceptable substitute is Type-MFR529 Focus Variable Resistor, part no. 99-170201</i>	99-170200
Transistors		
Q901	Type-2SC1106 Transistor	99-170194
Q902	Type-2SD870 Transistor <i>Acceptable substitutes are Type-2SD869 Transistor, part no. 99-170196; Type-2SD900B Transistor, part no. 99-170197; and Type-2SD898B Transistor, part no. 99-170198</i>	99-170195
Miscellaneous Hardware		
L901	0.2 μ H Ferrite Core	99-170199
	▲ Type-19VKUP22 Cathode-Ray Tube	99-170193
	Degaussing Coil	99-170192
	Left Frame	99-170203
	Right Frame	99-170204
	Bottom Plate	99-170205
(Q901)	Left Bracket	99-170206
(Q902)	Right Bracket	99-170207
	PCB Holder	99-170208
	Flyback-Transformer Holder	99-170209
(Q402)	Heat Sink	99-170210
(Q403)	Heat Sink	99-170210
	AC Cord Bushing	99-170211
	Handle Bushing	99-170212
	6.4 x 20 x 1.6t Washer	99-170217
	3.5 x 10 x 0.8t Washer	99-170218
	CBTA-3 x 8, Self-Tapping Screw	99-170219
	CBTA-4 x 8, Self-Tapping Screw	99-170220
	M6 Nut (F)	99-170221
	M3 Nut (H)	99-170222

Appendix A

Waveforms

NOTE

All waveforms were taken using a crosshatch-pattern generator signal.

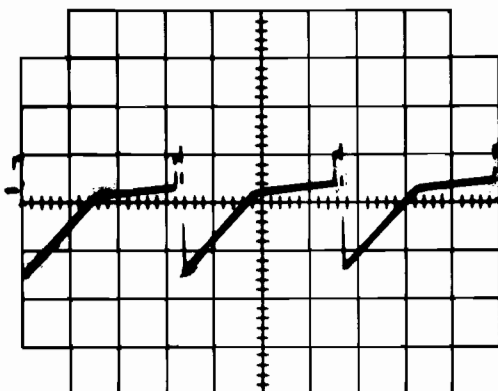

1. VERTICAL DRIVE
At pin 1 of IC401. H: 5 ms/cm.
V: 1 V/cm.

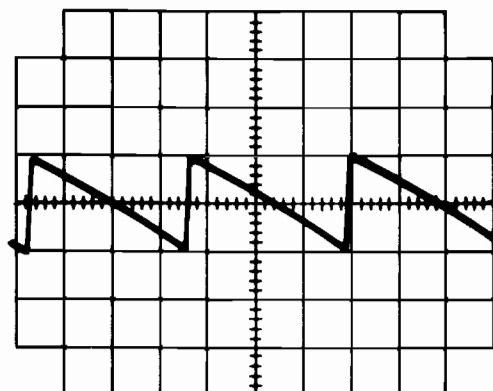

2. VERTICAL FEEDBACK
At pin 2 of IC401. H: 5 ms/cm.
V: 1 V/cm.

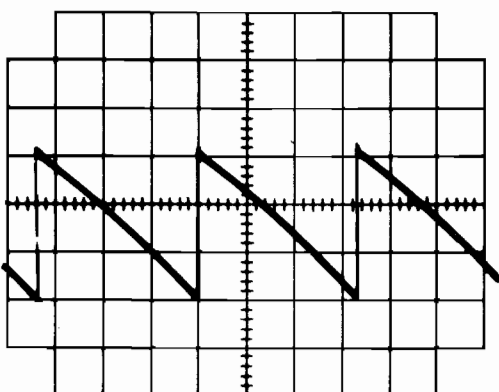

3. VERTICAL OSC 1
At pin 3 of IC401. H: 5 ms/cm.
V: 1 V/cm.

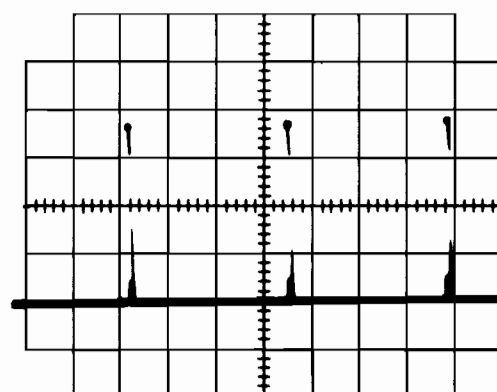

4. VERTICAL OSC 2
At pin 6 of IC401. H: 5 ms/cm.
V: 1 V/cm.

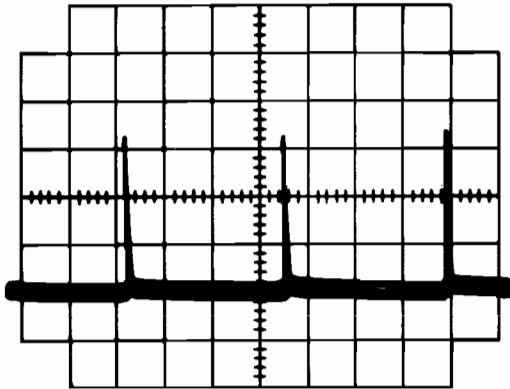

5. VERTICAL TRIGGER
At pin 7 of IC401. H: 5 ms/cm.
V: 1 V/cm.

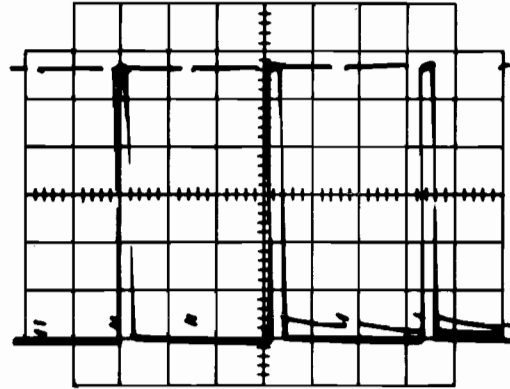

6. SYNC OUTPUT
At pin 8 of IC401. H: 20 μ s/cm.
V: 2 V/cm.

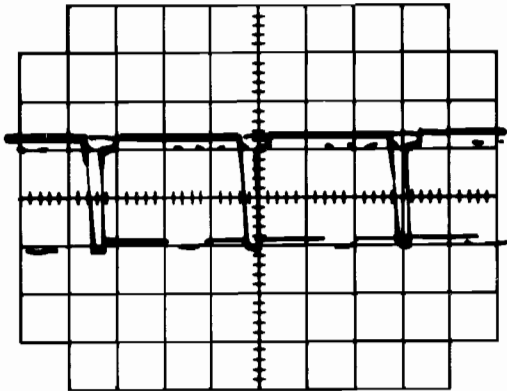

7. SYNC INPUT
At pin 10 of IC401. H: 20 μ s/cm.
V: 1 V/cm.

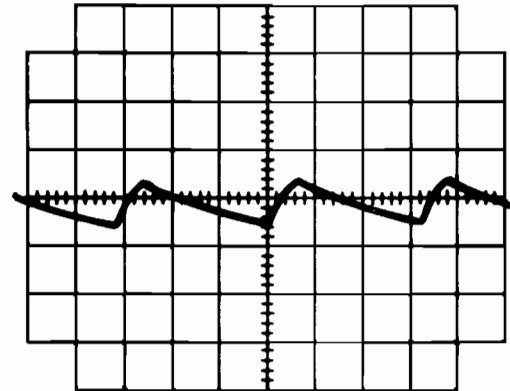

8. FLYBACK INPUT
At pin 11 of IC401. H: 20 μ s/cm.
V: 0.5 V/cm.

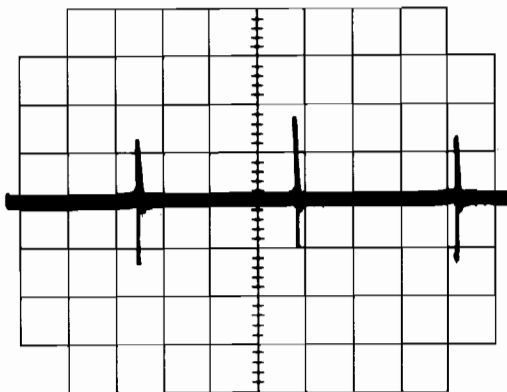

9. AFC FILTER
At pin 12 of IC401. H: 5 ms/cm.
V: 1 V/cm.

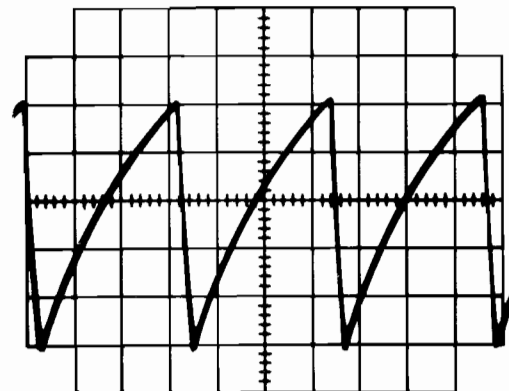

10. HORIZONTAL OSC
At pin 13 of IC401. H: 20 μ s/cm.
V: 1 V/cm.

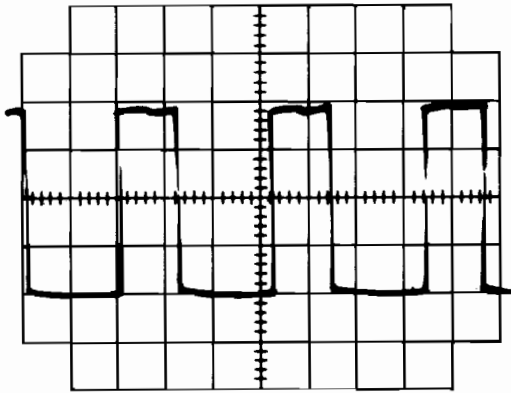

11. HORIZONTAL PRE-DRIVE
OUTPUT
At pin 15 of IC401. H: 20 μ s/cm.
V: 1 V/cm.

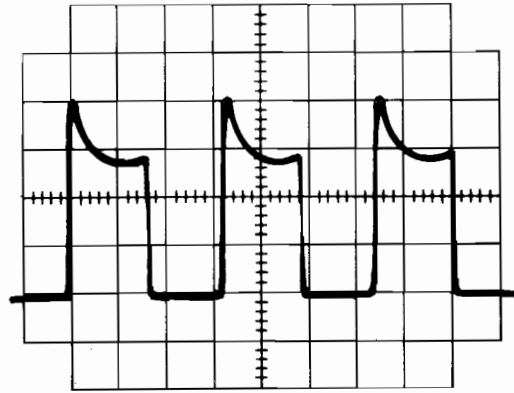

12. HORIZONTAL PRIMARY DRIVE
At collector of Q501. H: 20 μ s/cm.
V: 20 V/cm.

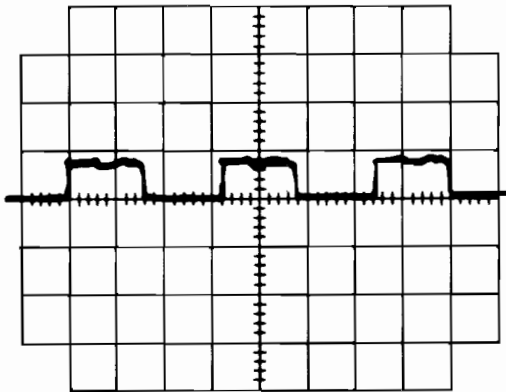

13. HORIZONTAL PRE-DRIVE INPUT
At base of Q501. H: 20 μ s/cm.
V: 1 V/cm.

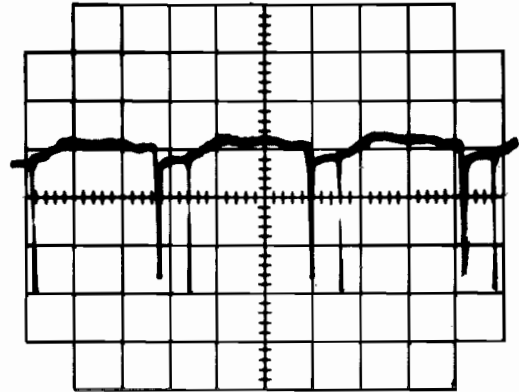

14. HORIZONTAL SECONDARY DRIVE
At base of Q902. H: 20 μ s/cm.
V: 5 V/cm.

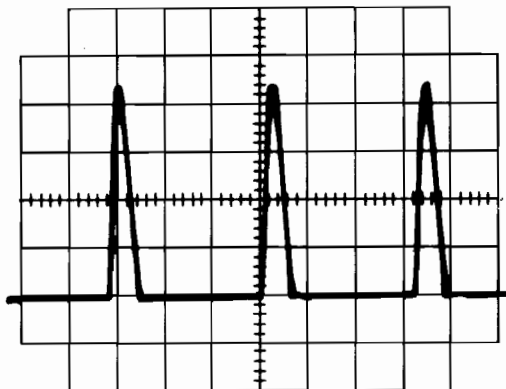

15. HORIZONTAL OUTPUT
At collector of Q902. H: 20 μ s/cm.
V: 200 V/cm.

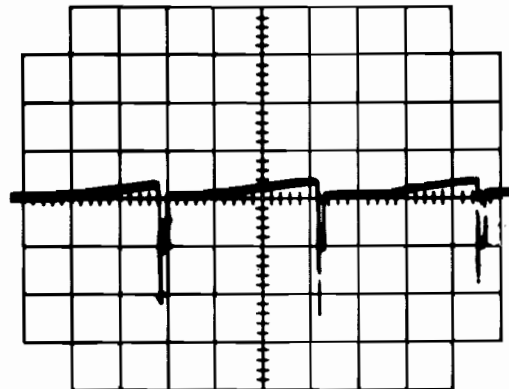

16. VERTICAL DRIVE INPUT-1
At base of Q403. H: 5 ms/cm.
V: 0.5 V/cm.

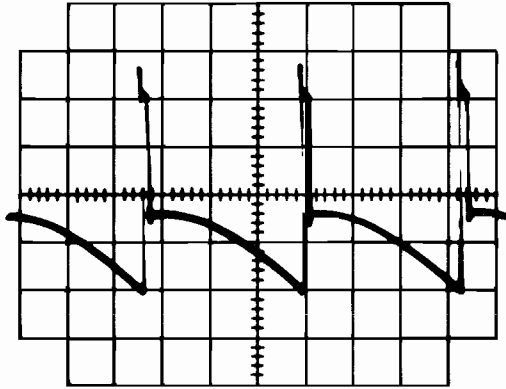

17. VERTICAL OUTPUT-1
At collector of Q403. H: 5 ms/cm.
V: 20 V/cm.

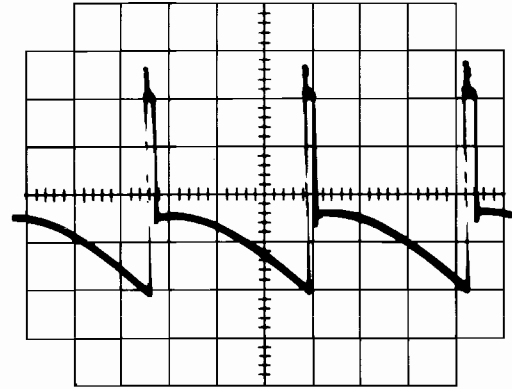

18. VERTICAL OUTPUT-2
At emitter of Q402. H: 5 ms/cm.
V: 20 V/cm.

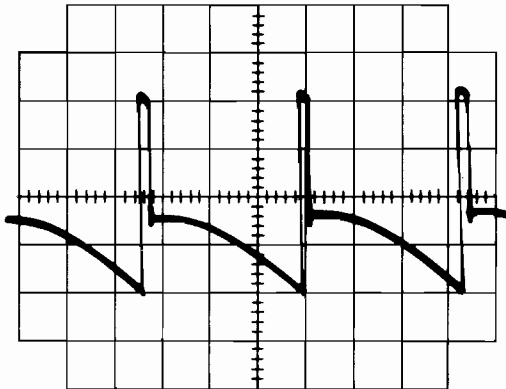

19. VERTICAL DRIVE INPUT-2
At base of Q402. H: 5 ms/cm.
V: 20 V/cm.

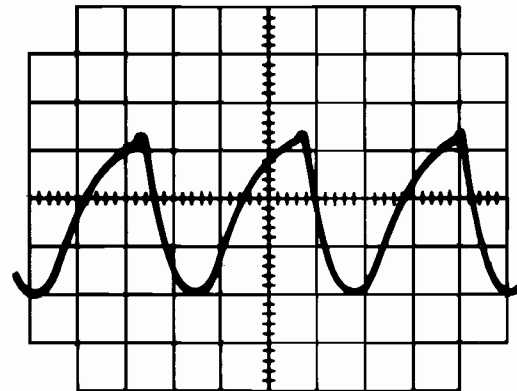

20. VERTICAL B+
At collector of Q402. H: 5 ms/cm.
V: 5 V/cm.

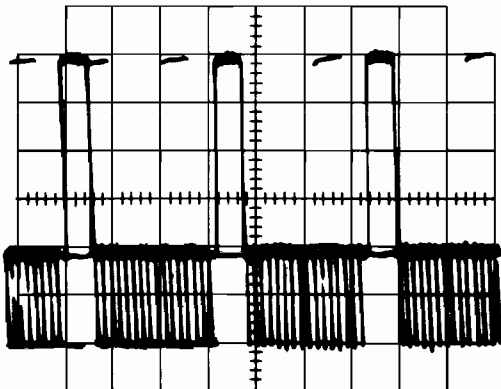

21. R.G.B. OUTPUT
At collector of Q701-Q703. H: 20 μ s/cm.
V: 20 V/cm.

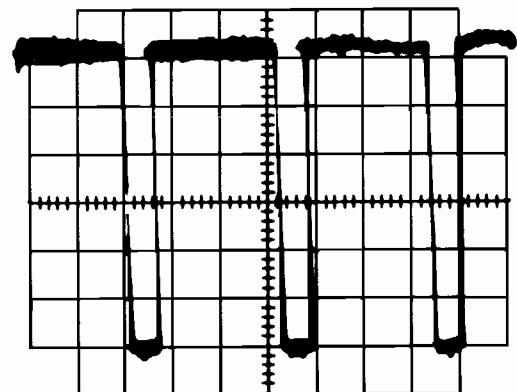

22. BLANKING OUTPUT
At collector of Q202. H: 20 μ s/cm.
V: 1 V/cm.

Appendix B

AC

Alternating current; from zero it rises to a maximum positive level, then passes through zero again to a maximum negative level.

ACTIVE STATE

The true state of a signal. For example: The active state for START is low.

ADDRESS

A value that identifies a specific location of data in memory; normally expressed in hexadecimal notation.

ANALOG

Measurable in an absolute quantity (as opposed to on or off). Analog devices are volume controls, light dimmers, stereo amplifiers, etc.

ANODE

The positive (arrow) end of a diode.

AMPLIFIER

A device used to increase the strength of an applied signal.

AMPLITUDE

The maximum instantaneous value of a waveform pulse from zero.

ASTABLE

Having no normal state. An astable device will free-run or oscillate as long as operating voltage is applied. The oscillation frequency is usually controlled by external circuitry.

AUXILIARY COIN SWITCH

A momentary-contact pushbutton switch with a black cap located on the utility panel. The auxiliary coin switch adds credits to the game without activating the coin counter.

BEZEL

A cut, formed, or machined retention device, such as the conical device used to mount a pushbutton switch to a control panel, or the formed device used to frame the video display screen.

BIDIRECTIONAL

Able to send or receive data on the same line (e.g., the data bus of a microprocessor).

BINARY

A number system that expresses all values by using two digits (0 and 1).

BIT

A binary digit; expressed as a 1 or a 0.

BLANKING

Turning off the beam on a cathode-ray tube during retrace.

BLOCK DIAGRAM

A drawing in which functional circuitry units are represented by blocks. Very useful during initial troubleshooting.

BUFFER

1. An isolating circuit designed to eliminate the reaction of a driven circuit on the circuits driving it (e.g., a buffer amplifier).

2. A device used to supply additional drive capability.

BUS

An electrical path over which information is transferred from any of several sources to any of several destinations.

CAPACITOR

A device capable of storing electrical energy. A capacitor blocks the flow of DC current while allowing AC current to pass.

CATHODE

The negative end of a diode.

CHIP

An integrated circuit comprising many circuits on a single wafer slice.

CLOCK

A repetitive timing signal for synchronizing system functions.

COINCIDENCE

Occurring at the same time.

COIN COUNTER

A 6-digit electro-mechanical device that counts the coins inserted in the coin mechanism(s).

COIN MECHANISM

A device on the inside of the coin door that inspects the coin to determine if the correct coin has been inserted.

COMPLEMENTARY

Having opposite states, such as the outputs of a flip-flop.

COMPOSITE SYNC

Horizontal and vertical synchronization pulses that are bused together into a single signal. This signal provides the timing necessary to keep the display in synchronization with the game circuitry.

COMPOSITE VIDEO

Complete video signal from the game system to drive the display circuitry, usually comprising H SYNC, V SYNC, and the video.

Glossary

CREDIT

One play for one person based on the game switch settings.

CRT

Cathode-ray tube.

DATA

General term for the numbers, letters, and symbols that serve as input for device processing.

DARLINGTON

A two-transistor amplifier that provides extremely high gain.

DC

Direct current, meaning current flowing in one direction and of a fixed value.

DEFLECTION YOKE

Electro-magnetic coils around the neck of a cathode-ray tube. One set of coils deflects the electron beam horizontally and the other set deflects the beam vertically.

DIAGNOSTICS

A programmed routine for checking circuitry. For example: the self-test is a diagnostic routine.

DIODE

A semiconductor device that conducts in only one direction.

DISCRETE

Non-integrated components, such as resistors, capacitors, and transistors.

DMA

Direct memory access. DMA is a process of accessing memory that bypasses the microprocessor logic. DMA is normally used for transferring data between the input/output ports and memory.

DOWN TIME

The period during which a game is malfunctioning or not operating correctly due to machine failure.

EAROM

Electrically alterable read-only memory (see ROM). The EAROM is a memory that can be changed by the application of high voltage.

FLYBACK

A step-up transformer used in a display to provide the high voltage.

GATE

1. A circuit with one output that responds when and only when a certain combination of pulses is present at the inputs.

2. A circuit in which one signal switches another signal on and off.
3. To control the passage of a pulse or signal.

HARNESS

A prefabricated assembly of insulated wires and terminals ready to be attached to a piece of equipment.

HEXADECIMAL

A number system using the equivalent of the decimal number 16 as a base. The symbols 0-9 and A-F are usually used.

IMPLODE

To burst inward; the inward collapse of a vacuum tube.

I/O

Input/Output.

IRQ

Interrupt request. IRQ is a control signal to the microprocessor that is generated by external logic. This signal tells the microprocessor that external logic needs attention. Depending on the program, the processor may or may not respond.

LED

The abbreviation for a light-emitting diode.

LOCKOUT COIL

Directs coins into the coin return box when there is no power to the game.

LOGIC STATE

The binary (1 or 0) value at the node of a logic element or integrated circuit during a particular time. Also called the logic level. The list below shows the voltage levels corresponding to the logic states (levels) in a TTL system.

Logic 0, Low = 0 VDC to +0.8 VDC
Grey Area (Tri-State Level) = +0.8 VDC to +2.4 VDC
Logic 1, High = +2.4 VDC to +5 VDC

MULTIPLEXER

A device that takes several low-speed inputs and combines them into one high-speed data stream for simultaneous transmission on a single line.

NMI

Non-maskable interrupt. NMI is a request for service by the microprocessor from external logic. The microprocessor cannot ignore this interrupt request.

PAGE

A subsection of memory. A read-only memory device (see ROM) is broken into discrete blocks of data. These blocks are called pages. Each block has X number of bytes.

PCB

The abbreviation for a printed-circuit board.

PHOTOTRANSISTOR

A transistor that is activated by an external light source.

POTENTIOMETER

1. A resistor that has a continuously moving contact which is generally mounted on a moving shaft. Used chiefly as a voltage divider. Also called a *pot* (slang).
2. An instrument for measuring a voltage by balancing it against a known voltage.

RAM

Random-access memory. A device for the temporary storage of data.

RASTER-SCAN DISPLAY

A display system whereby images are displayed by continuously scanning the cathode-ray tube horizontally and vertically with an electron beam. The display system controls the intensity of the electron beam.

RETRACE

In a raster-scan display, retrace is the time during which the cathode-ray tube electron beam is resetting either from right to left or from bottom to top.

RESISTOR

A device designed to have a definite amount of resistance. Used in circuits to limit current flow or to provide a voltage drop.

ROM

Read-only memory. A device for the permanent storage of data.

SIGNATURE ANALYSIS

A process of isolating digital logic faults at the component level by means of special test equipment called signature analyzers. Basically, signature analyzers (e.g., the ATARI® CAT Box) convert lengthy bit streams into four-digit hexadecimal signatures. The signature read by the analyzer at each circuit node is then compared with the known good signature for that node. This process continues until a fault is located.

TROUBLESHOOT

The process of locating and repairing a fault.

VECTOR

A line segment drawn between specific X and Y coordinates on a cathode-ray tube.

WATCHDOG

A counter circuit designed to protect the microprocessor from self-destruction if a program malfunction occurs. If

a malfunction does occur, the counter applies continuous pulses to the reset line of the microprocessor, which causes the microprocessor to keep re-setting.

X-Y DISPLAY

A display system whereby images are displayed with vectors.

ZENER DIODE

A special diode used as a regulator. Its main characteristic is breaking down at a specified reverse-bias (Zener) voltage.

YOUR COMMENTS, PLEASE!

Your comments will assist Atari in improving our publications. The comments are an important part of preparing for revisions of game manuals. Please write in the space below. No postage stamp is necessary if mailed in the U.S.A.

If you have any technical questions about certain ATARI games products, or are requesting additional publications, we will immediately forward your note to the appropriate person.

Page: Comments:

Fill in if you wish a reply:

Name _____

Firm _____

Address _____

City _____ State _____ Zip _____

Area Code _____ Phone _____

Distributor

Operator

Other _____

First fold



No Postage
Necessary
if mailed in
the United States

BUSINESS REPLY MAIL
FIRST CLASS PERMIT NO. 1004 SUNNYVALE, CA

POSTAGE WILL BE PAID BY ADDRESSEE

Atari, Inc.
Attn.: Field Service/Coin-Op Division
P. O. Box 427
Sunnyvale, California 94086



Second fold

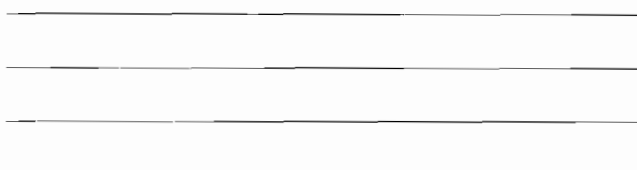

From:

Tape this edge

NOTES

NOTES

NOTES



NOTES

If reading through this manual does not lead to solving a certain maintenance problem, call TELEHELP® at the Atari Customer Service office in your geographical area, as shown below.

WEST and CENTRAL U.S.A.

Parts and Service

Atari, Inc.
California Customer Service Office
1105 N. Fair Oaks Avenue
P. O. Box 427, Sunnyvale, CA 94086
Telex 17-1103
(Monday-Friday, 7:30-4:00 pm Pacific Time)

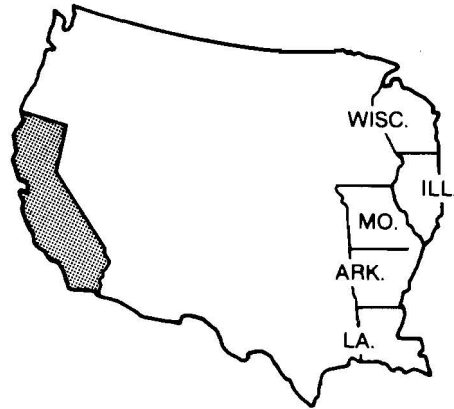

-  From California, Alaska, or Hawaii
(408) 745-2900
-  Service from anywhere in the area shown in white
toll-free (800) 538-1611



EAST U.S.A.

Service only

Atari, Inc.
New Jersey Customer Service Office
12A World's Fair Drive, Somerset, NJ 08873
Telex 37-9347
(Monday-Friday, 7:30-4:00 pm Eastern time)

-  From New Jersey
(201) 469-5993
-  From anywhere else in this area
toll-free (800) 526-3849



EUROPE

Parts and Service

Atari Ireland Limited
European Customer Service Office
Tipperary Town, Ireland
Telex 28165
(Monday-Friday, 9:00-6:00 pm GMT)

-  062-52155

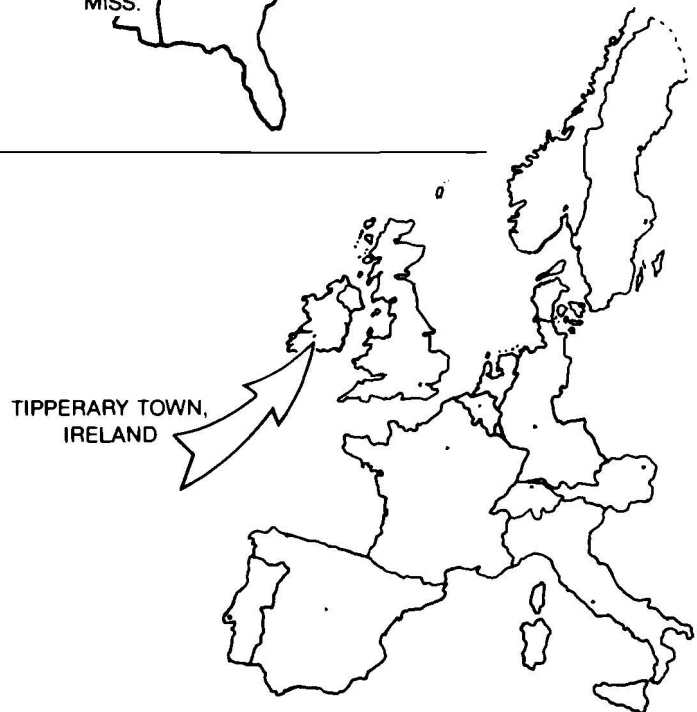



ATARI, INC.
790 SYCAMORE DRIVE
P.O. BOX 906
MILPITAS, CALIFORNIA 95035
408/942-3100 • TELEX 35-7488

Warner Communications Company

