

**BALLY SENTE MAINFRAME
Master Cable Modification Notice**

The Master Cable Assembly in your Bally Sente Mainframe Unit (Sac 1, Sac 1A, Sac 1B, Sac-Man or C.T. Mainframe) may have (as shown in its wiring diagram):

1. One wire connected between jack connector J14 (to coin door) & jack connector P19 (to power supply).
2. One wire connected between jack connector J20 (to control panel) & jack connector P19 (to power supply).

If not, then Master Cable Assembly must be modified (using Master Cable Kit) as follows:

- A. Cut green or green-white (G-W) wire at location K of cable connector P7 (22-position).
- B. Connect green-white (G-W) wire from kit to cable connector P19 at pin 10 (to power supply). Connect other end of wire, using wire nut, to cut wire going to coin door jack connector J14 at pins 5 & 8 (Sac 1, Sac 1A, & Sac 1B); pin 3 (C.T. mainframe) or loose wire going to two "12V" positions on J14 (Sac-Man).
- C. Cut green or green-red (G-R) wire at location L of cable connector P7.
- D. Connect green-red (G-R) wire from kit to cable connector P19 at pin 11 (to power supply). Connect other end of wire, using wire nut, to cut wire going to control panel jack connectors J16 at pin 5 and J20 at pin 5.

NAME THAT TUNE

OPTION SWITCH SETTINGS - DIP SWITCH "H1"

//////////////////////////////////// COINS PER CREDIT //////////////////////////////////////

VARIOUS CREDIT OPTIONS

SW#1 SW#2 SW#3 SW#4 SW#5 SW#6 SW#7 SW#8

FREE PLAY	OFF	OFF	OFF	OFF	OFF	OFF	OFF	OFF
* 1 COIN / 1 CREDIT	ON	ON						
1 COIN / 2 CREDITS	OFF	ON						
2 COINS / 1 CREDIT	ON	OFF						
3 COINS / 1 CREDIT	OFF	OFF						

//////////////////////////////////// COINS ADD BONUS COINS //////////////////////////////////////

* NO BONUS COINS			ON	ON	ON			
2 COINS ADDS 1 BONUS COIN			OFF	ON	ON			
3 COINS ADDS 1 BONUS COIN			ON	OFF	ON			
4 COINS ADDS 1 BONUS COIN			OFF	OFF	ON			
4 COINS ADDS 2 BONUS COINS			ON	ON	OFF			
5 COINS ADDS 1 BONUS COIN			OFF	ON	OFF			
5 COINS ADDS 2 BONUS COINS			ON	OFF	OFF			
5 COINS ADDS 3 BONUS COINS			OFF	OFF	OFF			

//////////////////////////////////// COIN MECH MULTIPLIER //////////////////////////////////////

* LEFT COIN MECH X 1							ON	
LEFT COIN MECH X 2							OFF	
* RIGHT COIN MECH X 1								ON
RIGHT COIN MECH X 4								OFF
RIGHT COIN MECH X 5								ON
RIGHT COIN MECH X 6								OFF

* INDICATED FACTORY RECOMMENDED SETTINGS	PART NO. M051-00E54-A007
--	--------------------------

NAME THAT TUNE

OPTION SWITCH SETTINGS - DIP SWITCH "G1"

//////////////////// VARIOUS GAME PLAY OPTIONS //////////////////////

	<u>SW#1</u>	<u>SW#2</u>	<u>SW#3</u>	<u>SW#4</u>	<u>SW#5</u>	<u>SW#6</u>	<u>SW#7</u>	<u>SW#8</u>
* BEST 3 OF 5 WINS ROUND BEST 4 OF 7 WINS ROUND	OFF ON					XX XX		
* 18,000 FOR BONUS ROUND 21,000 FOR BONUS ROUND 15,000 FOR BONUS ROUND ALWAYS PLAY BONUS ROUND		OFF ON	OFF OFF					
* SHOW CORRECT ANSWER DO NOT SHOW CORRECT ANSWER					OFF ON			
* DOES NOT RESET AVAILABLE SONGS RESET ALL SONGS AT GAME START					OFF ON			
* 1 PLAYER PER CREDIT 1 OR 2 PLAYERS PER CREDIT							OFF ON	
* NO SOUNDS IN ATTRACT * SOUNDS IN ATTRACT								OFF ON
* INDICATED FACTORY RECOMMENDED SETTINGS	PART NO. M051-00E54-A007							

Name That Tune game review

Please disregard Self-Test and Attract Mode information shown on page 6 of Bally-Sente Field Conversion Kit Manual (M051-00C47-A019). Refer to information on this page instead.

Self Test

Due to the tremendous amount of data in this game, no Self Test is available.

Attract Mode

- When game is first powered on, a blank screen with the message, "Please stand by..." appears for approximately 10 seconds while the sound board is being initialized. When the message begins to pulsate, final initialization will be taking place. If there are any sound board error modes, they will be displayed at this time.
- Title screen will appear (approx. 18 seconds).
- Tune Topics screen with four song titles will appear (approx. 18 seconds).

If attract sound is enabled, 1 out of every eight screens will play a song.

- High score screen will appear (approx. 18 seconds).
- Cycle repeats from step 2.

Game Description

Name That Tune is a 1 or two player game. The game consists of three rounds: Tune Topics, Bid A Note, and a bonus round called Golden Medley. In order to play the bonus round, the player must obtain a switch-selectable number of points; or this round can be selected to always be played. The basic play consists of hearing a song play and selecting one of four choices using the answer buttons.

Play begins with the computer randomly choosing a Topic, e.g., "For the Birds", which contains such songs as Woody Woodpecker, When Doves Fly, etc. The player(s) then hear the first song from the Topic. Four Song Titles are displayed on the monitor. As the song plays, the song value and bonus value for the round count down. The faster the player answers, the higher his score. In a two player game, an incorrect answer gives the other player a chance to correctly answer the tune. If neither player wins, no bonus points are awarded. The number of songs heard in each round is switch-selectable (best of 5 or best of 7).

The next round is Bid A Note. A clue is displayed, e.g., "A 1972 Top 10 Hit"; The player(s) then "Bid" on the number of notes they need to name the tune. The lower the bid, the higher the song value. The bidding starts at 9 and can go down to 1. In this round, only the melody of the song is heard as played on a piano. In a two player game, an incorrect answer causes the points to be awarded to the other player.

The Golden Medley can always be played or set to be played only on scoring 5,000, 18,000, or 21,000 points. This is played only by the winning player in a two player game. The player has 15 seconds to name five songs correctly. He may pass and go on to the next song. An incorrect answer ends the game and no bonus points are scored.

Whether or not the correct answer is displayed is switch-selectable.

Important Note: Please be advised that when converting a game it is advisable that all former trademark and copyright registrations be removed in the conversion process.

NAME THAT TUNE

OPTION SWITCH SETTINGS - DIP SWITCH "H1"

//////////////////////////////////// COINS PER CREDIT //////////////////////////////////////

<u>VARIOUS CREDIT OPTIONS</u>	<u>SW#1</u>	<u>SW#2</u>	<u>SW#3</u>	<u>SW#4</u>	<u>SW#5</u>	<u>SW#6</u>	<u>SW#7</u>	<u>SW#8</u>
FREE PLAY	OFF	OFF	OFF	OFF	OFF	OFF	OFF	OFF
* 1 COIN / 1 CREDIT	ON	ON						
1 COIN / 2 CREDITS	OFF	ON						
2 COINS / 1 CREDIT	ON	OFF						
3 COINS / 1 CREDIT	OFF	OFF						

//////////////////////////////////// COINS ADD BONUS COINS //////////////////////////////////////

* NO BONUS COINS			ON	ON	ON			
2 COINS ADDS 1 BONUS COIN			OFF	ON	ON			
3 COINS ADDS 1 BONUS COIN			ON	OFF	ON			
4 COINS ADDS 1 BONUS COIN			OFF	OFF	ON			
4 COINS ADDS 2 BONUS COINS			ON	ON	OFF			
5 COINS ADDS 1 BONUS COIN			OFF	ON	OFF			
5 COINS ADDS 2 BONUS COINS			ON	OFF	OFF			
5 COINS ADDS 3 BONUS COINS			OFF	OFF	OFF			

//////////////////////////////////// COIN MECH MULTIPLIER //////////////////////////////////////

* LEFT COIN MECH X 1							ON	
LEFT COIN MECH X 2							OFF	
* RIGHT COIN MECH X 1								ON
RIGHT COIN MECH X 4								OFF
RIGHT COIN MECH X 5								ON
RIGHT COIN MECH X 6								OFF
* INDICATED FACTORY RECOMMENDED SETTINGS	PART NO. M051-00E54-A007							

NAME THAT TUNE

OPTION SWITCH SETTINGS - DIP SWITCH "G1"

//////////////////// **VARIOUS GAME PLAY OPTIONS** //////////////////////

	<u>SW#1</u>	<u>SW#2</u>	<u>SW#3</u>	<u>SW#4</u>	<u>SW#5</u>	<u>SW#6</u>	<u>SW#7</u>	<u>SW#8</u>
* BEST 3 OF 5 WINS ROUND BEST 4 OF 7 WINS ROUND	OFF ON					XX XX		
* 18,000 FOR BONUS ROUND 21,000 FOR BONUS ROUND 15,000 FOR BONUS ROUND ALWAYS PLAY BONUS ROUND		OFF ON	OFF OFF					
* SHOW CORRECT ANSWER DO NOT SHOW CORRECT ANSWER					OFF ON			
* DOES NOT RESET AVAILABLE SONGS RESET ALL SONGS AT GAME START					OFF ON			
* 1 PLAYER PER CREDIT 1 OR 2 PLAYERS PER CREDIT							OFF ON	
* NO SOUNDS IN ATTRACT * SOUNDS IN ATTRACT								OFF ON
* INDICATED FACTORY RECOMMENDED SETTINGS	PART NO. M051-00E54-A007							

**KIT PARTS LIST: NAME THAT TUNE U.R.
PART NO. GE54-00001-0000**

ORDER BY PART NUMBER ONLY

ITEM	PART NO.	DESCRIPTION
1	AE54-00004-0000	CONTROL PANEL ASSY.
	AE54-00005-0000	INSERT CABLE ASSY.
	OE54-00100-00XF	PANEL: INSERT ASSY.
	0017-00032-0092	SWITCH: SPDT P.C. MOMENT LED (2 REQ'D.)
	0017-00032-0150	SWITCH ASSY. P.B. SPST-RED (4 REQ'D.)
	0017-00032-0151	SWITCH ASSY. P.B. SPST-YELLOW (4 REQ'D.)
	0017-00042-0310	CABLE - CLAMP (2 REQ'D.)
	0017-00103-0089	NUT 5/8 - 24 (2 REQ'D.)
	0017-00104-0112	WASHER 650 - .87 - 22 (2 REQ'D.)
	0929-00905-00XF	BEZEL: SWITCH (2 REQ'D.)
2	AE54-00300-0000	KIT INSTRUCTION ASSY.
	M051-00E54-A007	TAG: OPTION SWITCH SETTING (2 REQ'D.)
	M051-00C47-A019	MANUAL: CONVERSION KIT
	M051-00E54-A006	GAME REVIEW SHEET: NAME THAT TUNE
	M051-00E54-A009	PARTS LIST: NAME THAT TUNE U.R. KIT
	M051-00E54-A005	CONTROL PANEL WIRING DIAGRAM: NAME THAT TUNE U.R.
	M051-00139-A002	SENTE MAINFRAME - MASTER CABLE MOD. WIRING DIAGRAM
	M051-00C47-A003	SAC 1A WIRING DIAGRAM
	M051-00E19-B003	SAC 1B WIRING DIAGRAM
	M051-00E23-A005	SAC-MAN WIRING DIAGRAM
	M051-00114-A148	COMPONENT LAYOUT: 256K CARTRIDGE
	M051-00114-A149	SCHEMATIC: 256K CARTRIDGE BD.
3	A084-91856-AE54	PROG. 256K CARTRIDGE: NAME THAT TUNE
4	U858-00632-0802	6 - 32 X 8 SOC BUTTON HD SCREW (9 REQ'D.)

M051-00E54-A009

KIT PARTS LIST: NAME THAT TUNE U.R.
PART NO. GE54-00001-0000

ORDER BY PART NUMBER ONLY

ITEM	PART NO.	DESCRIPTION
5	OE54-00900-0000	HEADER: UNDERLAY
6	0017-00103-0052	NUT 6 - 32 LOCKING (9 REQ'D.)
7	AE54-00006-0000	MASTER CABLE KIT
	M051-00139-A001	SENTE MAINFRAME - MASTER CABLE MOD. NOTICE SHEET

M051-00E54-A009

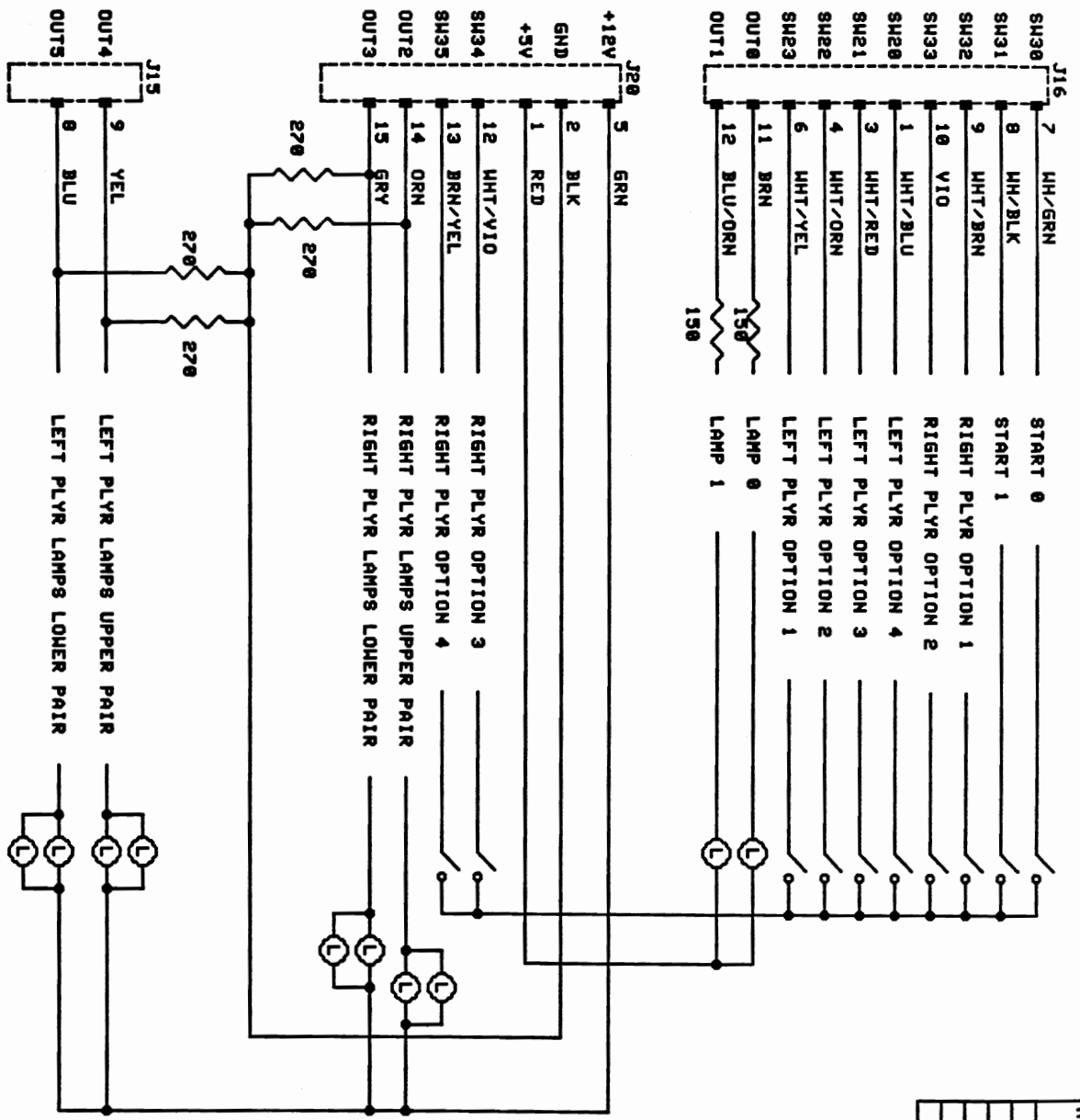

NOTES:	BALLY SENTE, INC.
H STONE	NAME THAT TUNE U.R.
3/20/86	CONTROL PANEL WIRING
	M051-00554-0005
	SHEET 1 OF 1
	REV

* REFER TO STEP B OF MASTER CABLE MOD. PROCEDURE FOR PIN NUMBERS.

- THE MASTER CABLE ASSEMBLY IN YOUR BALLY-SENTE MAINFRAME UNIT (SAC 1, SAC 1A, SAC 1B, SAC-MAN OR C.T. MAINFRAME) SHOULD HAVE (AS SHOWN IN ITS WIRING DIAGRAM):
1. ONE WIRE CONNECTED BETWEEN JACK CONNECTOR J14 (TO COIN DOOR) & JACK CONNECTOR P19 (TO POWER SUPPLY).
 2. ONE WIRE CONNECTED BETWEEN JACK CONNECTOR J20 (TO CONTROL PANEL) & JACK CONNECTOR P19 (TO POWER SUPPLY).
- IF NOT, THEN MASTER CABLE ASSEMBLY MUST BE MODIFIED, (USING MASTER CABLE KIT) AS FOLLOWS:
- A. CUT GREEN OR GREEN-WHITE (G-M) WIRE AT LOCATION K OF CABLE CONNECTOR P7(22 POS).
 - B. CONNECT GREEN-WHITE (G-M) WIRE FROM KIT TO CABLE CONNECTOR P19 AT PIN 10 (TO POWER SUPPLY), CONNECT OTHER END OF WIRE, USING WIRE NUT, TO CUT WIRE GOING TO COIN DOOR JACK CONNECTOR J14 AT PINS 5 & 8 (SAC 1, SAC 1A, & SAC 1B); PIN 3 (C.T. MAINFRAME) OR LOOSE WIRE GOING TO "12V" POSITIONS ON J14 (SAC-MAN).
 - C. CUT GREEN OR GREEN-RED (G-R) WIRE AT LOCATION L OF CABLE CONNECTOR P7.
 - D. CONNECT GREEN-RED (G-R) WIRE FROM KIT TO CABLE CONNECTOR P19 AT PIN 11 (TO POWER SUPPLY). CONNECT OTHER END OF WIRE, USING WIRE NUT, TO CUT WIRE GOING TO CONTROL PANEL JACK CONNECTORS J16 AT PIN 5 AND J20 AT PIN 5.

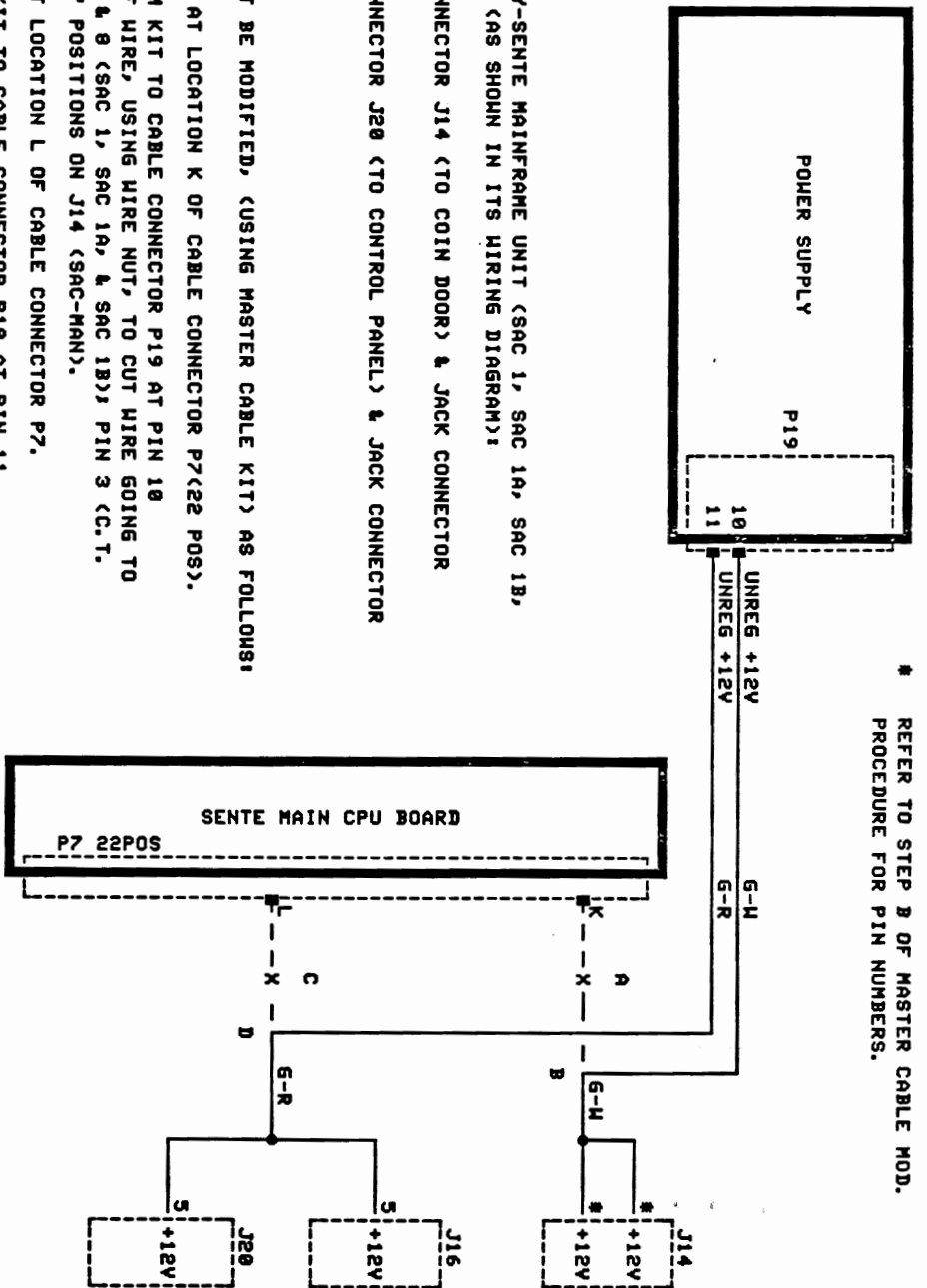

NOTES:	
M STONE	BALLY SENTE, INC.
3/20 86	SENTE MAINFRAME
	MASTER CABLE MODIFICATION
	DIAGRAM,
	MO51-00139-A002
	SHEET 1 OF 1 REV

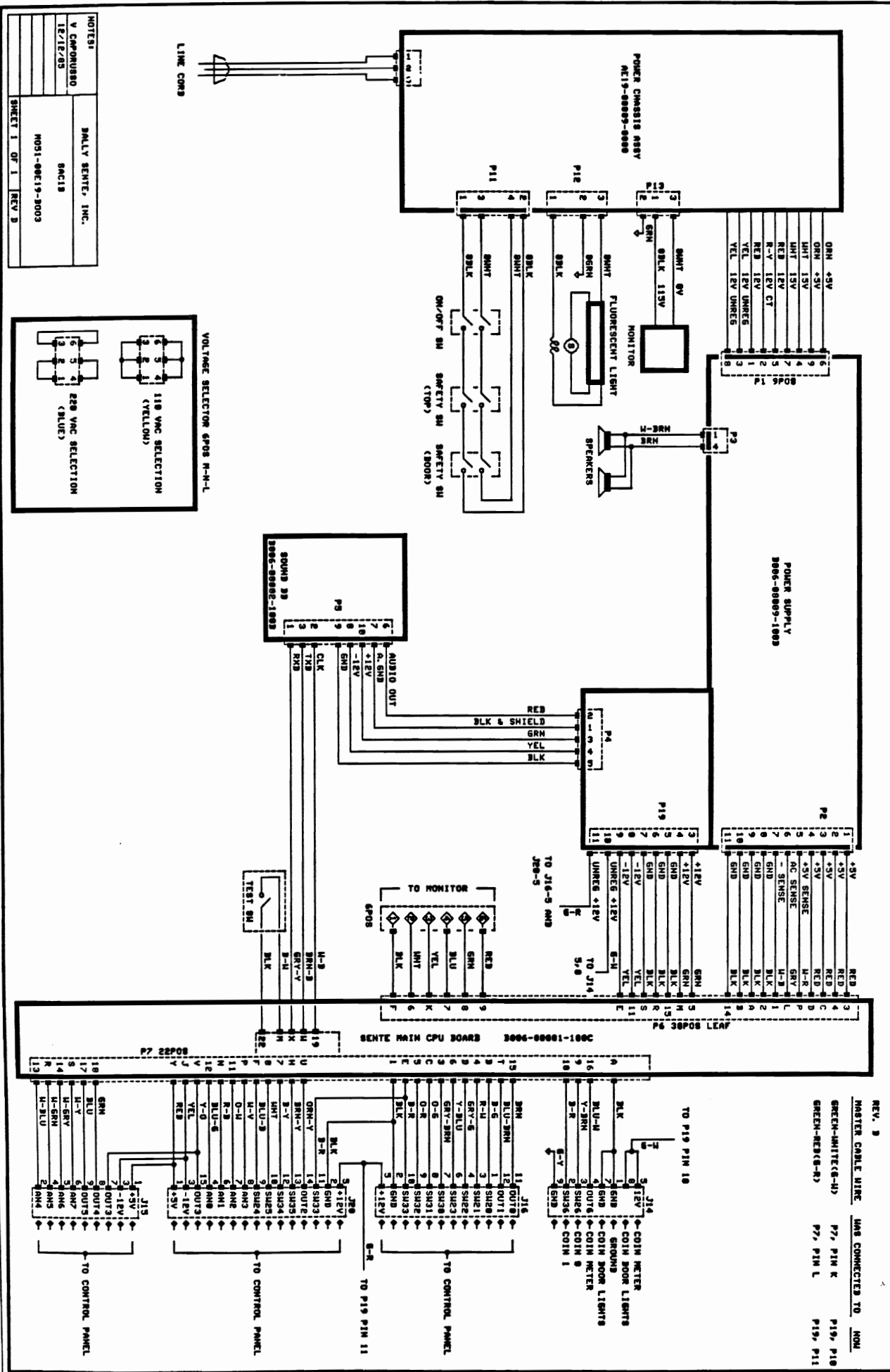

REV. 3

MASTER CABLE WIRE HAS CONNECTED TO MON
 GREEN-WHITE(G-W) P7, PIN K P19, P10
 GREEN-RED(G-R) P7, PIN L P19, P11

TO P19 PIN 10

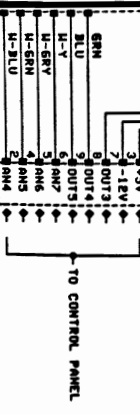
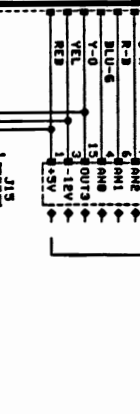
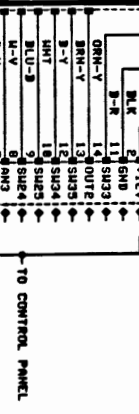
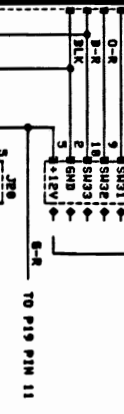
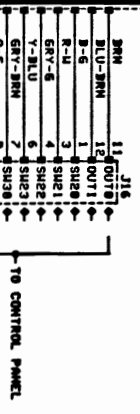
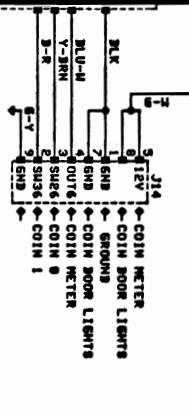

NOTES:

V CAPROUSED	BALLY SENTE, INC.
12/12/05	8AC18
	M051-00C19-3003
	SHEET 1 OF 1 REV B

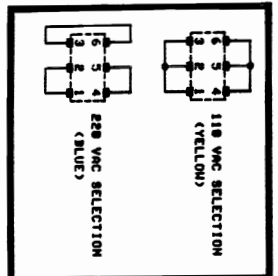

ULTRA SECURE CARTRIDGE, 296K BOARD
 U006-08030-010A
 A082-91556-8000
 M051-00114-AW8

CROSS REFERENCE LIST

DESCRIPTION	QTY.	DESIGNATION NO.	PART NOS.
P.C. BOARD	1	U6R	U007-08030-010A
ST1002 CUST.	1	U8C	U260-00050-010A
X2212 RAM	1	U5C	U230-00007-0100
74LS245	1	U4R	U200-00036-0100
74LS74	1	U4C	U200-00044-0100
74LS10	1	U5R	0360-00803-0046
74LS139	1	U1A, U2A, U3A, U4A	U200-00049-0100
28 PIN SOCKET	10	U5A, U6A, U7A, U8A	110E-00001-0010
40 PIN SOCKET	1	U7C, U5C	110E-00001-0011
20 PIN SOCKET	1	U6R	U510-00017-0100
2.2UF TANT 20V	2	U7C	U510-00013-0100
.1UF 50V	23	C24, C25	U300-00004-0100
CONNECTOR (2-102584-01)	1	C1 - C23	U350-00064-0100
		P1	

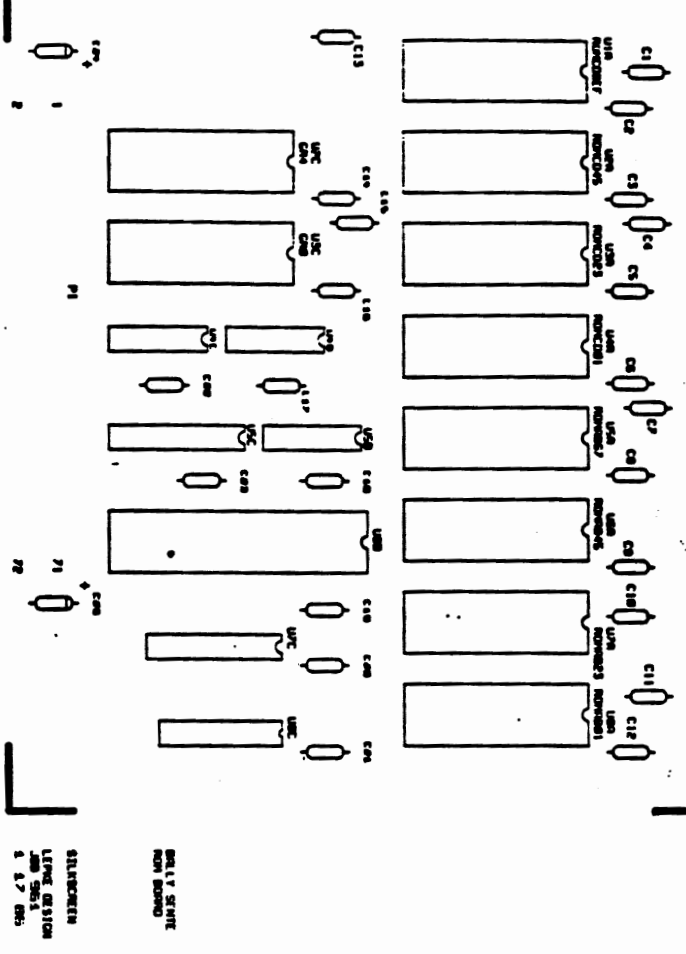

Rel JJ-2-27-86

REL FOR PRODUCTION

**THE SAC 1B PARTS & OPERATING MANUAL WAS NOT
AVAILABLE AT THE TIME OF PRODUCTION. PLEASE
REQUEST THE MANUAL BY COMPLETING & RETURNING
THE "INCOMPLETE MANUAL" CARD ENCLOSED WITH
YOUR GAME.**