

The Atari Historical Society
www.atari-history.com

POKEY
 COL2294

CONFIDENTIAL

REVISIONS				DRAWN BY.	DATE	 ATARI TITLE	ATARI INCORPORATED 1265 BORREGAS AVE. SUNNYVALE, CA. 94086		
SYM	DESCRIPTION	DATE	APPV'D	CHECKED	DATE		SIZE	DRAWING NO.	REV
B	RELEASE PER ECN 5320	5-30-82	<i>EW</i>	<i>[Signature]</i>	3-9-82	A	COL2294	B	
				ENGINEER	3/15/82	POKEY CHIP			
				ENGINEER MGR.	<i>[Signature]</i>	SCALE	-	SHEET	1 OF 41
				QUALITY ASSURANCE					
				MFG. ENGINEER					

TABLE OF CONTENTS:

1. GENERAL DESCRIPTIONpage 3
 2. AUDIOpage 3
 3. KEYBOARD SCANpage 10
 4. POT PORTSpage 15
 5. TIMERSpage 17
 6. RANDOM NUMBER GENERATORpage 17
 7. SERIAL I/O PORTpage 18
 8. IRQ INTERRUPTSpage 23
 9. ELECTRICAL PARAMETERSpage 25
 A. GENERALpage 25
 B. D.C. AND OPERATING CHARACTERISTICSpage 25
 C. DYNAMIC OPERATING CHARACTERISTICSpage 28
 D. WRITE I/O TIMINGpage 29
 E. READ I/O TIMINGpage 30
 F. MISC. I/O TIMINGpage 31

TABLE OF ILLUSTRATIONS:

1. AUDIO NOISE FILTERSpages 5 & 6
 2. MUSICAL NOTE TABLEpage 9
 3. KEY SCAN FLOW CHARTpage 11
 4. TYPICAL KEYBOARD CONFIGURATIONpage 12
 5. KEY SCAN LINE TIMINGpage 13
 6. INTERNAL KEY SCAN LOGIC (BLOCK DIAGRAM).....page 14
 7. INTERNAL POT PORT LOGIC (BLOCK DIAGRAM).....page 16
 8. POKEY ADDRESS TABLEpage 32
 9. POKEY PIN LISTpage 33
 10. POKEY BONDING DIAGRAM.....page 34
 11. POKEY MOS LOGIC.....pages 35 - 41



TITLE			
POKEY CHIP			
DRAWING NO	CO12294	REV	B
SHEET	2	OF	4

1. GENERAL DESCRIPTION:

There are four semi-independent audio channels, each with its own frequency, noise and volume control. Each channel has an eight bit "divide by N" frequency divider and an eight bit control register, which selects the noise (polynomial counter) content and volume.

There are six key scan lines (K0-K5), which holds a value from 00 to 3F. There are two sense lines. One of the sense lines is for the full decode of the six scan lines. The other sense line is for decoding only the codes (CTRL, SHIFT, and BREAK-key).

There are eight pot ports for measuring input rise time. Each input has an eight bit counter which is clocked every TV line. Each input also has a dump transistor which is turned on or off by software.

There are three timers which use the audio channels. If start timer (STIMER) is enabled, the audio channels are reset.

There is a random number generator which is eight bits from a polynomial counter.

There is a serial I/O port. The serial port consists of a serial output line, a serial input line, a serial output clock line, and a bi-directional serial data clock line. Also there are control registers which are used to configure the serial port.

There are eight IRQ interrupts. They are BREAK key, OTHER key, SERIAL INPUT READY, SERIAL OUTPUT NEEDED, TRANSMISSION FINISHED, TIMER #4, TIMER #2, and TIMER #1. These interrupts can be enabled or disabled by software. There is also a register to read interrupt status.

2. AUDIO:

There are four semi-independent audio channels, each with its own frequency, noise, and volume control. Each channel has an eight bit "divide by N" frequency divider, controlled by an eight bit register (AUDFX). Each channel also has an eight bit control register (AUDCX) which selects the noise (polynomial counter) content and the volume.

All four frequency dividers can be clocked simultaneously from 64 KHZ or 15 KHZ by AUDCTL bit 0. Frequency dividers 1 and 3 can alternately be clocked from



TITLE

POKEY CHIP

DRAWING NO.

CO12294

REV

B

SHEET

3

OF

4

2. AUDIO (continued)

1.79 MHZ by setting AUDCTL bits 5 and 6. Frequency dividers 2 and 4 can alternately be clocked with the output of dividers 1 and 3 by setting AUDCTL bits 4 and

3. This allows the following options: 4 channels of 8 bit resolution, 2 channels of 16 bit resolution, or 1 channel of 16 bit resolution and 2 channels of 8 bit resolution.

There are three polynomial counters (17 bit, 5 bit and 4 bit) used to generate random noise. The 17 bit poly counter can be reduced to a 9 bit poly counter by bit 7 of AUDCTL. These counters are clocked by 1.79 MHZ. Their outputs, however, can be sampled independently by the four audio channels at a rate determined by each channel's frequency divider. Thus each channel appears to contain separate poly counters clocked at its own frequency. This poly counter noise sampling is controlled by bits 5, 6, and 7 of each AUDCX register. Because the poly counters are sampled by the "divide by N" frequency divider, the output obviously cannot change faster than the sampling rate. In these modes (poly noise outputted), the dividers are therefore acting as "low pass" filter clocks, allowing only the low frequency noise to pass.

The output of the noise control circuit described above consists of pure tones (square wave type), or polynomial counter noise at a maximum frequency set by the "divide by N" counter (low pass clock). This output can be routed through a high pass filter if desired by use of bits 1 and 2 of AUDCTL.

The high pass filter consists of a "D" flip flop and an exclusive-OR Gate. The noise control circuit output is sampled by this flip flop at a rate set by the "High Pass" clock. The input and output of the Flip Flop pass through the exclusive-OR Gate. However, if it is lower than the clock rate, the flip flop output will tend to follow the input and the two exclusive-OR Gate inputs will mostly be identical (11 or 00) giving very little output. This gives the effect of a crude high pass filter, passing noise whose minimum frequency is set by the high pass clock rate. Only channels 1 and 2 have such a high pass filter. The high pass clock for channel 1 comes from the channel 3 divider. The high pass clock for channel 2 comes from the channel 4 divider. This filter is included only if bit 1 or 2 of AUDCTL is true.

A volume control circuit is placed at the output of each channel. This is a crude 4 bit digital to analog converter that allows selection of one of 16 possible output current levels for a logic true audio input. A logic zero audio input to this volume circuit always gives an open circuit (zero current) output. The volume selection is controlled by bits 0 through 3 of AUDCX. "Volume Control only" mode



TITLE	POKEY CHIP		
DRAWING NO.	COL2294	REV B	SHEET 4 OF 41

2. AUDIO (continued)

can be invoked by forcing this circuit's audio input true with bit 4 of AUDCX. In this mode the dividers, noise counters, and filter circuits are all disconnected from the channel output. Only the volume control bits (0 to 3 of AUDCX) determine the channel output current.

The audio output of any channel can be completely turned off by writing zero to the volume control bits of AUDCX. All ones give maximum volume.

AUDIO NOISE FILTERS:

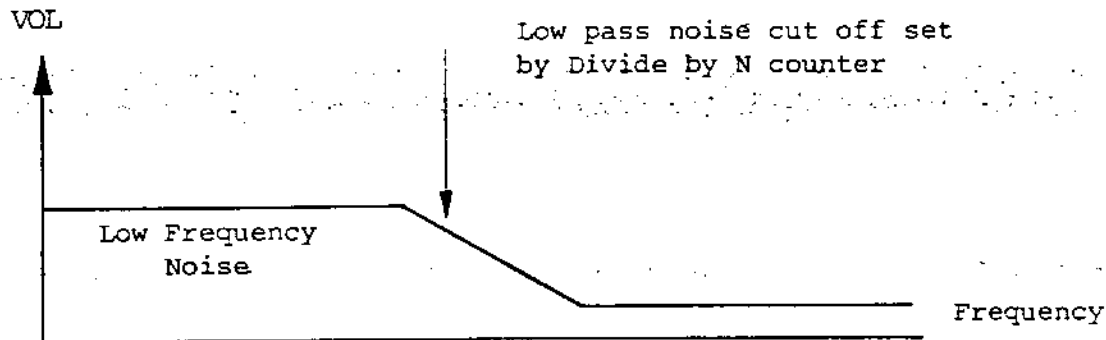

Any channel noise output (without high pass filter)

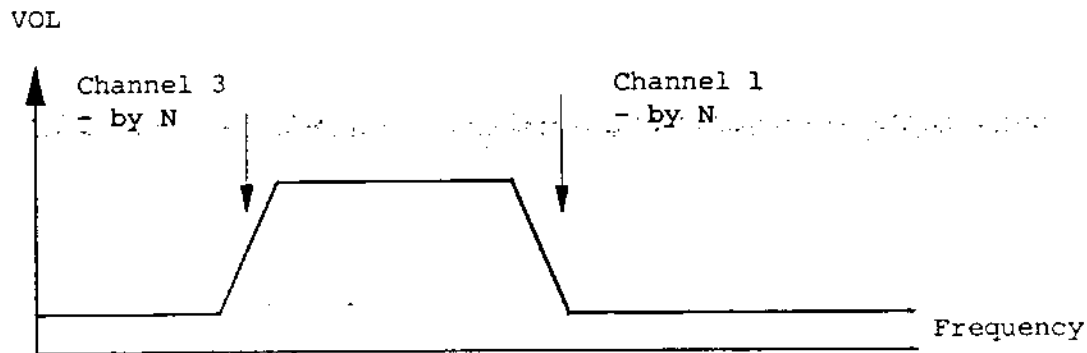

Channel 1 output (with high pass filter)

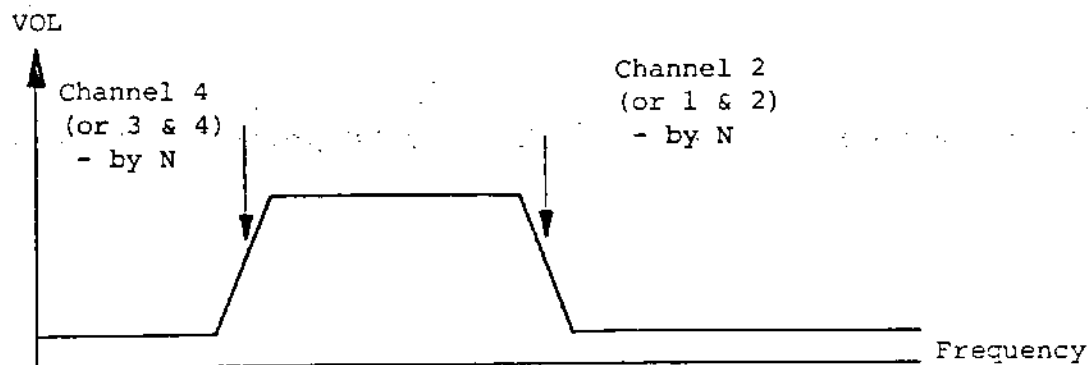

Channel 2 output (with high pass filter)

ALDIO NOISE FILTERS (continued):

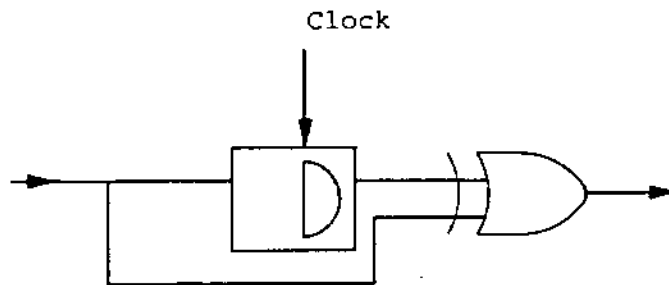

AUDCTL (Audio Control) (08): This address writes data into the Audio Mode Control Register. (Also see SKCTL two-tone bit 3 and notes).

D7	D6	D5	D4	D3	D2	D1	D0
----	----	----	----	----	----	----	----

- D7 Change 17 bit poly into a 9 bit below poly.
- D6 Clock Channel 1 with 1.79 MHZ, instead of 64 KHZ.
- D5 Clock Channel 3 with 1.79 MHZ, instead of 64 KHZ.
- D4 Clock Channel 2 with Channel 1, instead of 64 KHZ (16 BIT).
- D3 Clock Channel 4 with Channel 3, instead of 64 KHZ (16 BIT).
- D2 Insert Hi Pass Filter in Channel 1, clocked by Channel 3.
(See section II.)
- D1 Insert Hi Pass Filter in Channel 2, clocked by Channel 4.
- D0 Change Normal 64 KHZ frequency, into 15 KHZ.

Exact Frequencies: The frequencies given above are approximate. The Exact Frequency (F_{in}) that clocks the divide by N counters is given below (NTSC only, PAL different).

F_{in} (Approximate)	F_{in} (Exact)	
1.79 MHZ	1.78979 MHZ	- Use modified formula for F_{out}
64 KHZ	63.9210 KHZ	
15 KHZ	15.6999 KHZ	- Use normal formula for F_{out}



Audio (continued):

The Normal Formula for output frequency is:

$$F_{out} = F_{in}/2N$$

Where N = the binary number in the frequency register (AUDF), plus 1 (N=AUDF+1).

The MODIFIED FORMULA should be used when $F_{in} = 1.79 \text{ MHz}$ and a more exact result is desired:

$$F_{out} = \frac{F_{in}}{2(AUDF + M)}$$

Where: M = 4 if 8 bit counter (AUDCTL bit 3 or 4 = 0)

M = 7 if 16 bit counter (AUDCTL bit 3 or 4 = 1)

AUDF1, AUDF2, AUDF3, AUDF4, (Audio Frequency) (00, 02, 04, 06):

These addresses write data into each of the four Audio Frequency Control Registers.

Each register controls a divide by "N" counter.

D7	D6	D5	D4	D3	D2	D1	D0	"N"
0	0	0	0	0	0	0	0	1
0	0	0	0	0	0	0	1	2
ETC.								
1	1	1	1	1	1	1	1	256

Note: "N" is one greater than the binary number in Audio Frequency Register AUDF(X).

AUDC1, AUDC2, AUDC3, AUDC4 (Audio Channel Control) (01, 03, 05, 07):

These addresses write data into each of the four Audio Control Registers. Each Register controls the noise content and volume of the corresponding Audio Channel.

Noise Content or Distortion					Volume				
HEX	D7	D6	D5	D4	D3	D2	D1	D0	
0	0	0	0	0					Divisor "N" set by audio frequency register. - 17 BIT poly - 5 BIT poly - N
2	0	0	1	0					- 5 BIT poly - N - 2
4	0	1	0	0					- 4 BIT poly - 5 BIT poly - N
6	0	1	1	0					- 5 BIT poly - N - 2
8	1	0	0	0					- 17 BIT poly - N
A	1	X	1	0					- Pure Tone - N - 2
C	1	1	0	0					- 4 BIT poly - N
1	X	X	X	1					- Force Output (Volume only)
0					0	0	0	0	- Lowest Volume (Off)
8					1	0	0	0	- Half Volume
F					1	1	1	1	- Highest Volume

MUSICAL NOTE TABLE

PITCH VALUES FOR THE MUSICAL NOTES-AUDCTL =0, AUDC = hex AX

		Hex	Dec
HIGH NOTES	C	1D	29
	B	1F	31
	A# or Bb	21	33
	A	23	35
	G# or Ab	25	37
	G	28	40
	F# or Gb	2A	42
	F	2D	45
	E	2F	47
	D# or Eb	32	50
	D	35	53
	C# or Db	39	57
	C	3C	60
	B	40	64
	A# or Bb	44	68
	A	48	72
	G# or Ab	4C	76
	G	51	81
	F# or Gb	55	85
	F	5B	91
	E	60	96
	D# or Eb	66	102
	D	6C	108
	C# or Db	72	114
MIDDLE C	C	79	121
	B	80	128
	A# or Bb	88	136
	A	90	144
	G# or Ab	99	153
	G	A2	162
	F# or Gb	AD	173
	F	B6	182
	E	C1	193
	D# or Eb	CC	204
	D	D9	217
	C# or Db	E6	230
LOW : NOTES	C	F3	243



3. KEYBOARD SCAN:

The $\overline{K0-K5}$ lines hold a 6 bit value from 00 to 3 F. This allows for decoding 64 keys. With external CMOS (4052) chips, a key matrix is formed. The value of the key selected by the key matrix is returned on the $\overline{KR1}$ line.

Internal to the Pokey is a 6 bit binary counter, a 6 bit compare latch, and an 8 bit keycode latch. A control state machine does debouncing of the keys.

When the keyboard scanner is enabled by the SKCTL register, the binary counter begins to count, once per line. If the $\overline{KR1}$ line goes low, the value of the binary counter is transferred to compare latch. This will be the key code to be debounced. If $\overline{KR1}$ goes low before the next time the binary counter equals the compare latch then there are two keys depressed and both are ignored. If the binary counter equals the compare latch and $\overline{KR1}$ is high, then the key is bouncing and is ignored, but if $\overline{KR1}$ is low then the key is valid and it is transferred to the keycode latch for reading by the CPU. An IRQ is also sent indicating the key is ready. As soon as $\overline{KR1}$ is low and the binary counter equals compare latch, the key is still depressed. As soon as $\overline{KR1}$ is high, then the key will be checked for debounce. The next time the binary counter equals the compare latch and $\overline{KR1}$ is high, then the key is debounced and another key can be looked for. But if $\overline{KR1}$ is low, then the key is bouncing and is assumed to be still pressed.

If the debounce is disabled, the Pokey forces the binary counter equal compare latch signal to a logic true value which will disable debounce.

$\overline{KR2}$ input is used to decode 3 keys. They are SHIFT, BREAK and CONTROL. They do not get debounced. They are decoded only at:

	$\overline{K0}$	$\overline{K1}$	$\overline{K2}$	$\overline{K3}$	$\overline{K4}$	$\overline{K5}$
BREAK	= 1	1	1	1	0	0
SHIFT	= 1	1	1	1	0	1
CONTROL	= 1	1	1	1	1	1

KBCODE (Keyboard Code) (09): This address reads the Keyboard Code, and is usually read in response to a Keyboard Interrupt (IRQ and bits 6 or 7 of IRQST). See IRQEN for information on enabling keyboard interrupts. See SKCTL bits 1 and 0 for key scan and debounce enable.

D7	D6	D5	D4	D3	D2	D1	D0
----	----	----	----	----	----	----	----

D7 = Control Key
D6 = Shift Key



POKEY KEYBOARD SCAN
KEYSCAN CONTROL FLOW CHART

LOOKING
FOR
A
KEY

KEY
BOUNCE

VALID
KEY
DEPRESSED

KEY
DEBOUNCE

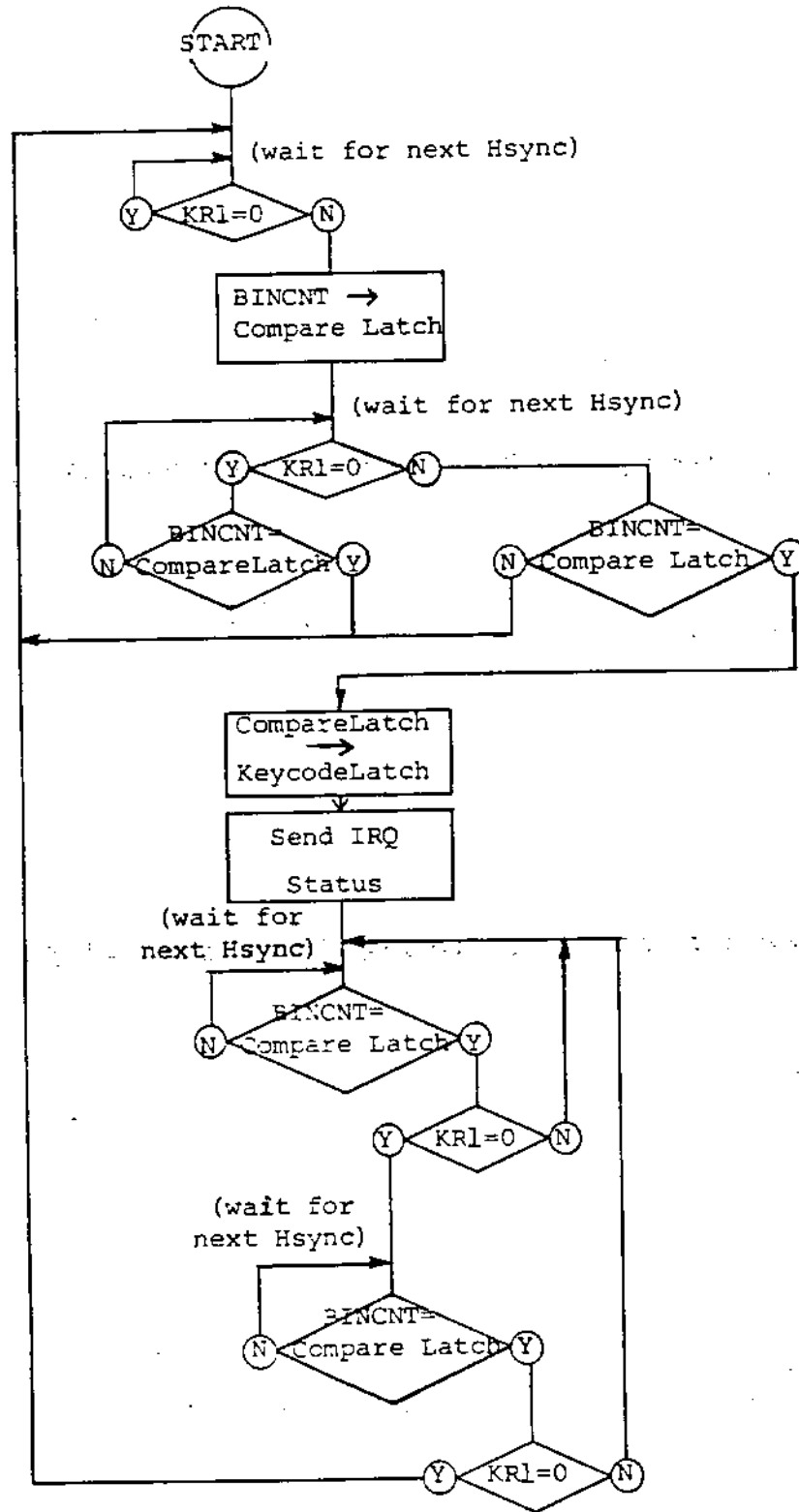

If Debounce Disable is in effect
then BINCNT = Compare Latch



POKEY KEYBOARD SCAN

	$\overline{K0}$	$\overline{K1}$	$\overline{K2}$	$\overline{K3}$	$\overline{K4}$	$\overline{K5}$
CNTL	1	1	1	1	1	1
SHFT	1	1	1	1	0	1
BRK	1	1	1	1	0	0

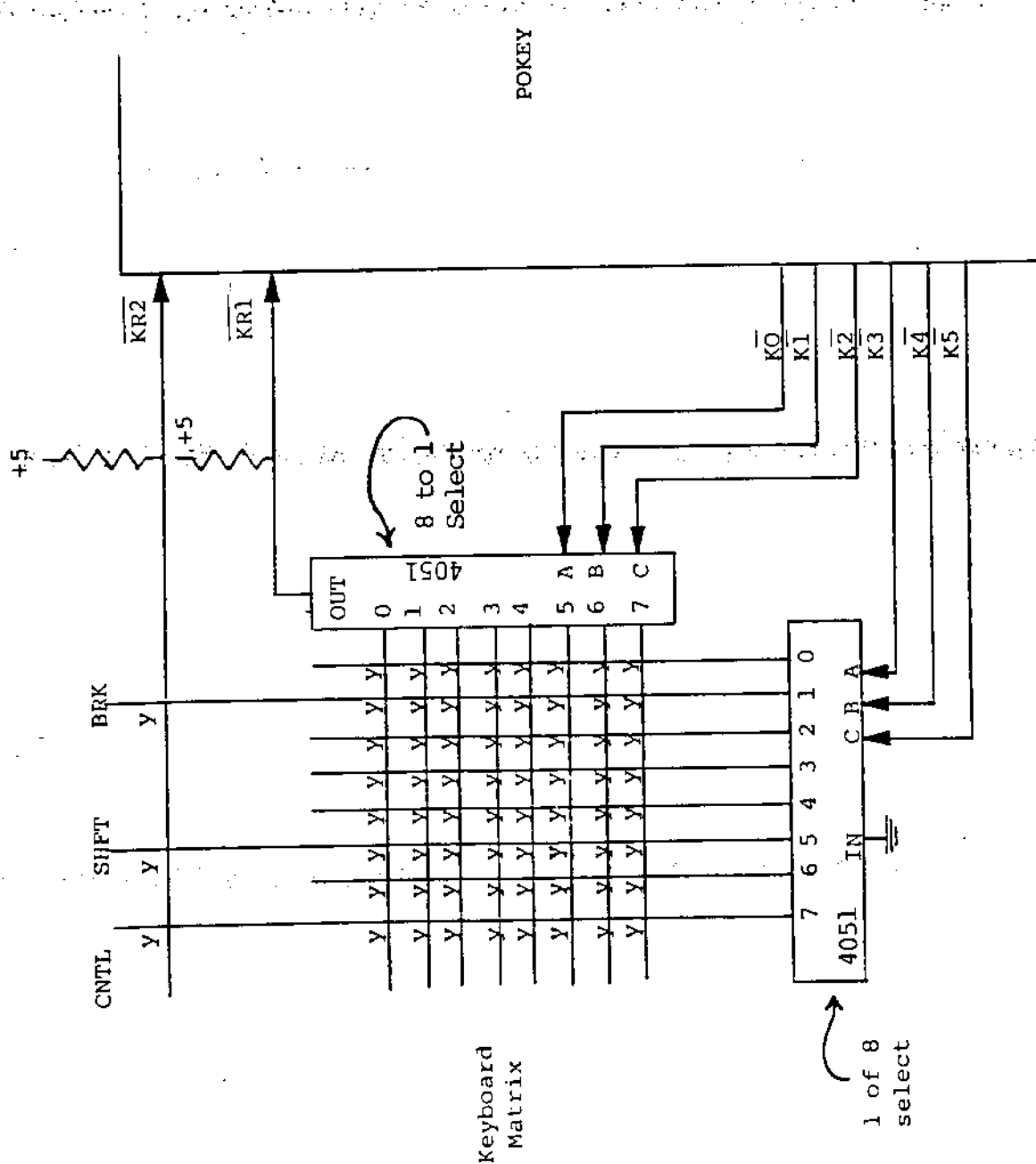

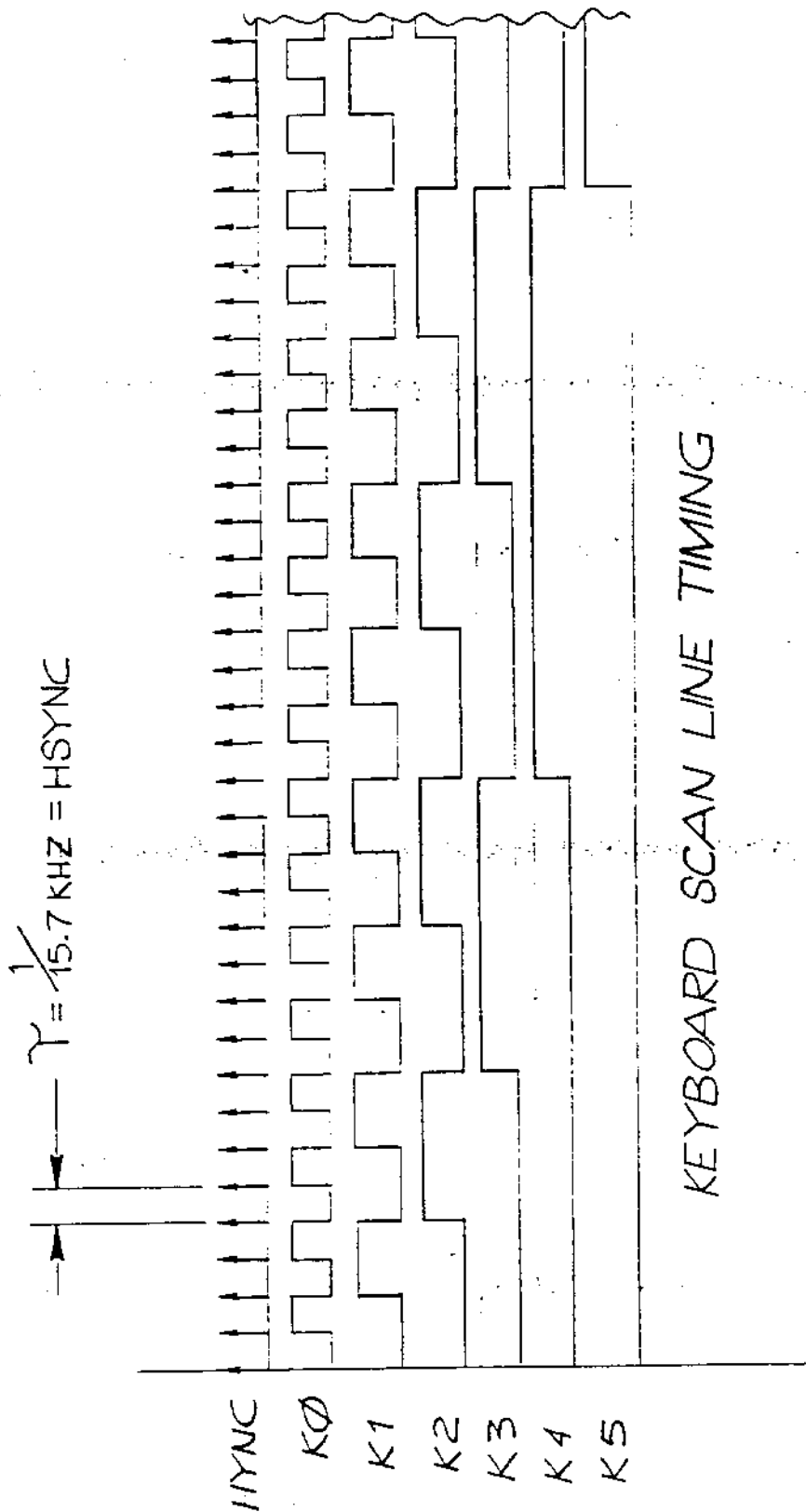

KEYBOARD SCAN LINE TIMING



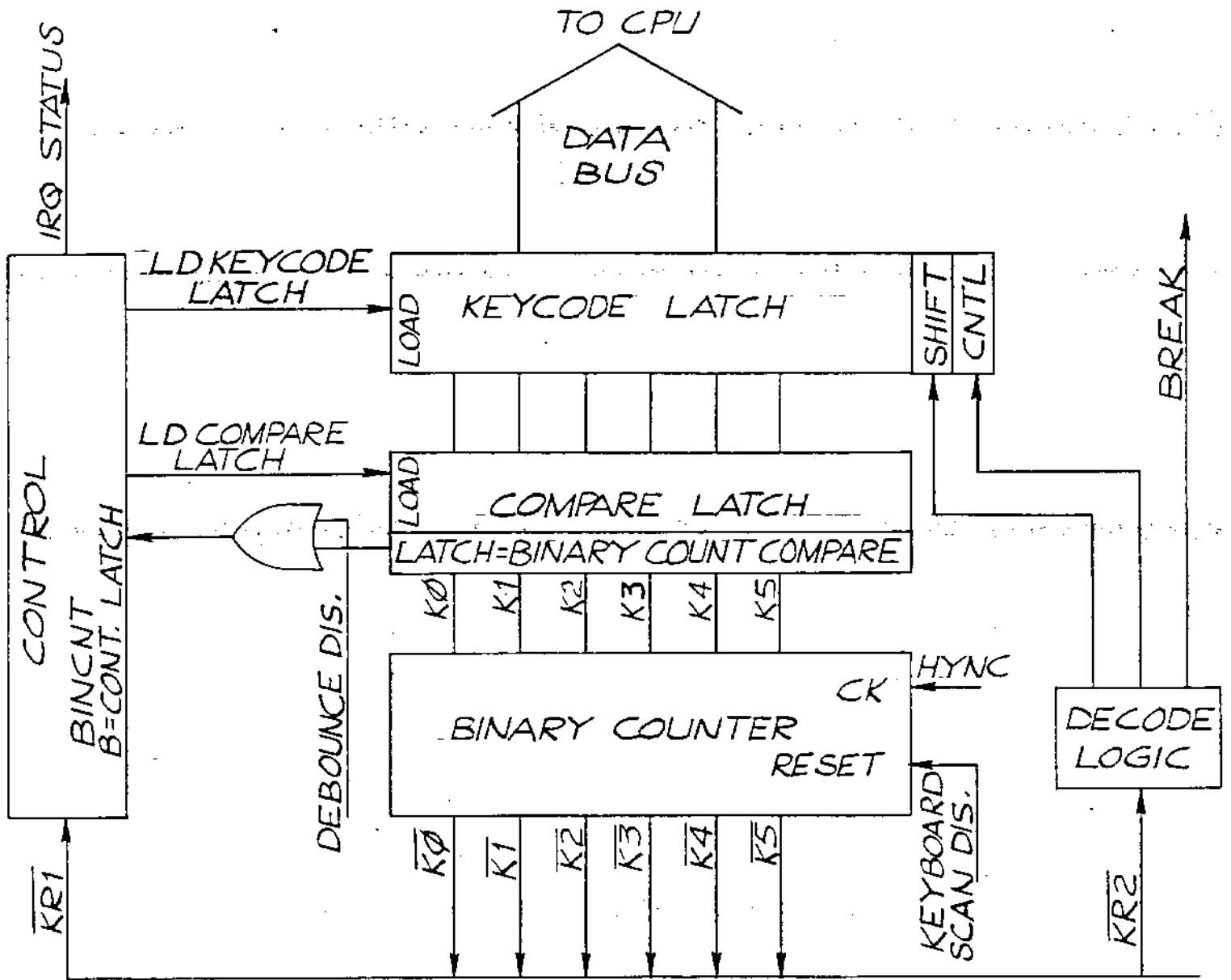

4. POT PORTS

There are eight pot input lines. Each line has a dump transistor and an eight bit latch. There is a binary counter that will count to 228. The counter is reset by strobing POTGO, which also releases the dump transistors. It also starts the binary counter to count once per line. The pot lines now will start to charge. When each line reaches a logic one, it will cause the counter value to be latched into its corresponding latch to be read by the CPU. When the counter reaches 228, the dump transistor is turned back on to pull the pot lines back to ground. The value in the latches will remain until the next POTGO strobe. To operate pot port:

- 1) \$03 -> SKCTL ; Turn off init.
- 2) During Vblank service routine, perform the following instructions:
 - A) Read POT0 to POT7 registers
 - B) Write to POTGO register (strobe)

There is an ALLPOT register which allows the logic value of each pot line to be read by the CPU. The main use of Allpot is in the fast scan mode. This is done by:

- 1) Place Pokey in fast scan mode. (SEE SKCTLS)
- 2) Write to POTGO address.
- 3) Wait four cycles of computer clock.
- 4) Now the Allpot register can be read.

NOTE: This address (as well as the fast scan mode) is useful only when the charging capacitors on the P0 - P7 PADS are removed, unless the pads are driven by buffer drivers.

POT0 - POT7 (Pot Values) (00 - 07): These addresses read the value (0 to 228) of 8 pots (paddle controllers) connected to the 8 lines pot port. The paddle controllers are numbered from left to right when facing the console keyboard. Turning the paddle knob clockwise results in decreasing pot values. The values are valid only after 228 TV lines following the "POTGO" command described below or after ALLPOT changes.

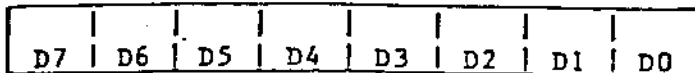

Each Pot Value (0-228)

ALLPOT (All Pot Lines Simultaneously) (08): This address reads the present digital value of the eight line pot port.

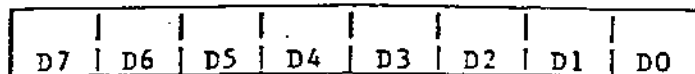

Pot number:

7 6 5 4 3 2 1 0

8 Pot Line States

- 0 = Pot register value is valid.
- 1 = Pot register value is not valid.



TITLE

POKEY CHIP

DRAWING NO. C012294

REV B

SHEET 15

OF 41

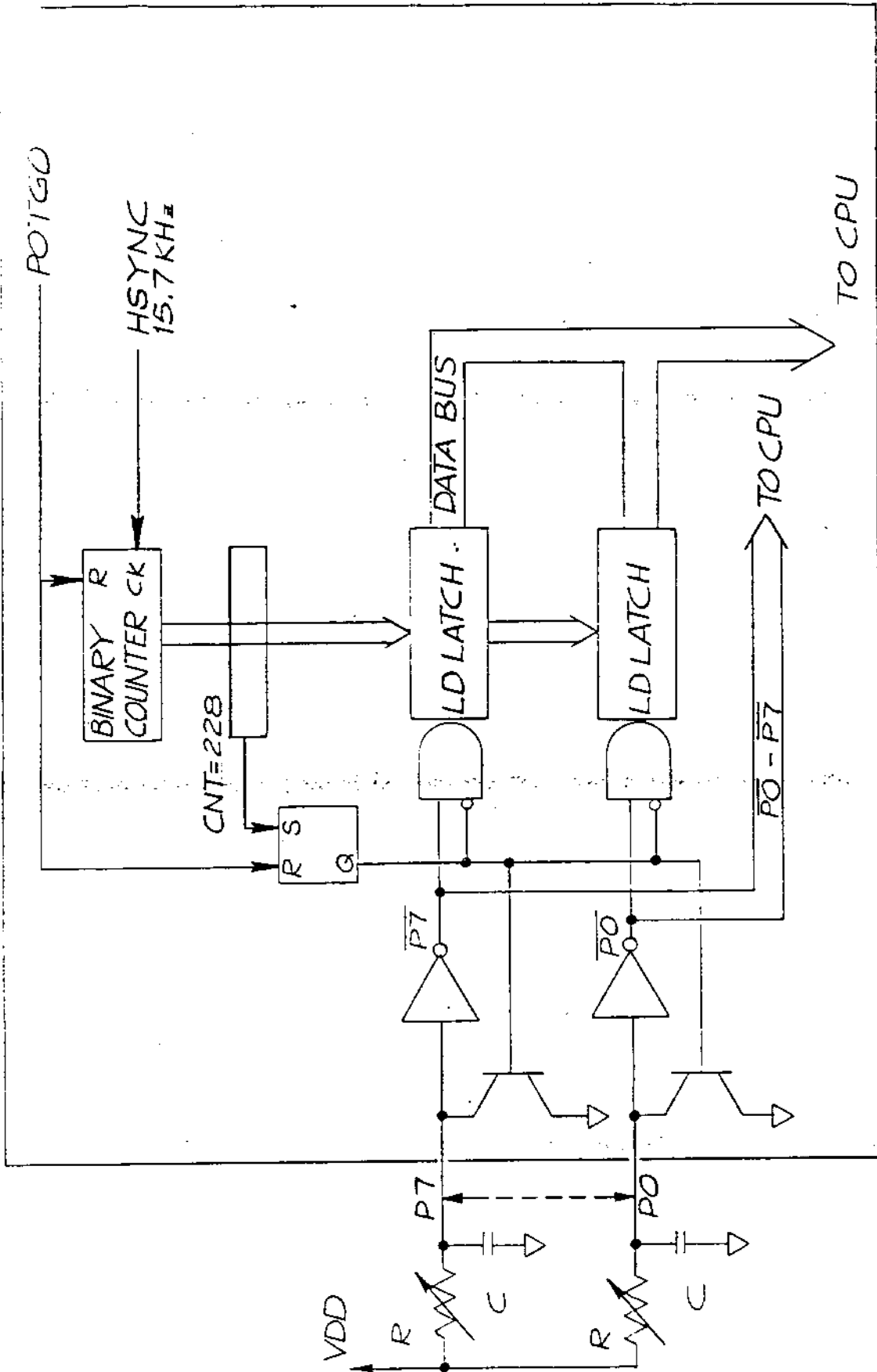

POTGO (Start Pot Scan) (0B):

No Data Bits Used

This write address starts the pot scan sequence. The pot values (POT0 - POT7) should be read first. This write strobe is then used causing the following sequence:

- 1) Scan Counter cleared to zero.
- 2) Capacitor dump transistors turned off.
- 3) Scan Counter begins counting.
- 4) Counter value captured in each of 8 registers (POT0 - POT7) as each pot line crosses trigger voltage.
- 5) Counter reaches 228, capacitor dump transistors turned on.

5. TIMERS:

Three of the audio channels can be used as timers. Audio channels 1, 2, and 4 are the channels that will cause IRQ interrupts for the timers. If interrupts are enabled, the interrupts will be caused by the audio channel crossing zero. The audio channel divide can be set to their "AUDF" value by strobing STIMER register. By strobing STIMER, the audio outputs are forced to a known state which are logic high for channels 1 and 2, and logic low for channels 3 and 4.

STIMER (Start TIMER) (09):

NOT USED

6. RANDOM NUMBER GENERATOR:

There is a seventeen bit polynomial counter that the CPU can read eight bit of the counter. The polynomial counter can be changed to nine bits by use of AUDCTL. If the Pokey is in the initial state (see SKCTLS), the counter is set to all ones state, therefore, the CPU will read \$FF.

RANDOM (Random Number Generator) (0A): This address reads the high order 8 bits of a 17 bit polynomial counter (9 bit, if bit 7 of AUDCTL = 1).

D7	D6	D5	D4	D3	D2	D1	D0
----	----	----	----	----	----	----	----



TITLE	POKEY CHIP		
DRAWING NO.	COL2294	REV B	SHEET 17 OF 4

7. SERIAL PORT

The serial port consists of a serial data output (transmission) line, a serial data input (receiver) line, a serial output clock line, a bi-directional serial data clock line, and other miscellaneous control lines described in the Operating System Manual. Data is transmitted and received as 8 bits of serial data preceded by a logic zero start bit, and succeeded by a logic true stop bit. Input and output clocks are equal to the baud (bit) rate, not 16 times baud rate. Transmitted data changes when the output clock goes true. Received data is sampled when the input clock goes to zero.

Serial Output: The transmission sequence begins when the processor writes 8 bits of parallel data into the serial output register (SEROUT). When any previous data byte transmission is finished the hardware will automatically transfer new data from (SEROUT) to the output shift register; interrupt the processor to indicate an empty (SEROUT) register (ready to be reloaded with the next byte of data), and automatically serially transmit the shift register contents with start-stop bits attached. If the processor responds to the interrupt, and reloads SEROUT before the shift register is completely transmitted, the serial transmission will be smooth and continuous.

Output data is normally transmitted as logic levels (+4V= true, 0V= false). Data can also be transmitted as two tone information. This mode is selected by bit 3 of SKCTL. In this mode audio channel 1 is transmitted in place of logic true, and audio channel 2 in place of logic zero. Channel 2 must be the lower tone of the tone pair.

The processor can force the data output line to zero (or to audio channel 2, if in two tone mode) by setting bit 7 of SKCTL. This is required to force a break (10 zeros) code transmission.

Serial Output Clock: The serial output data always changes when the serial output clock goes true. The clock then returns to zero in the center of the output data bit time.

The baud (bit) rate of the data and clock is determined by audio channel 4 audio channel 2, or by the input clock, depending on the serial mode selected by bits 4, 5, and 6 of SKCTL. (See chart at end of this section.)

Serial Input: The receiving sequence begins when the hardware has received a complete 8 bit serial data word plus start and stop bits. This data is automatically transferred to the 8 bit parallel input register (SERIN), and the processor is interrupted to indicate an input data byte ready to read in SERIN. The processor must



TITLE

POKEY CHIP

DRAWING NO. C012294

REV B

SHEET 18

OF 4

Serial Input (continued)

respond to this interrupt, and read SERIN, before the next input data word reception is complete, otherwise an input data "over-run" will occur. This over-run will be indicated by bit 5 of SKSTAT (if bit 5 of IRQST is not RESET (true) before next input complete), and means input data has been lost. This bit should be tested whenever SERIN is read. Bit 7 of SKSTAT should also be tested to detect frame errors caused by extra (or missing) data bits.

Direct Serial Input: The serial data input line can be read directly by the microprocessor if desired, ignoring the shift register, by reading bit 4 of SKSTAT.

Bi-Directional Clock: This clock line is used to either receive a clock from an external clock source for clocking transmitted or received data, or is used to supply a clock to external devices indicating the transmit or reception rate. This clock line direction is determined by the serial mode selected by bits 4, 5, and 6 of SKCTL. (See mode chart at the end of this section.) Transmitted data changes on the rising edge of this clock. Received data is sampled on the trailing edge of this clock.

Asynchronous Serial Input: Unclocked serial data (at an approximately known (+5%) rate) can be received in the asynchronous modes. The receive (input) shift register is clocked by audio channel 4. Channels 3 and 4 should be used together (AUDCTL bit 3 = 1) for increased resolution. In asynchronous modes, channels 3 and 4 are reset by each start bit at the beginning of each serial data byte. This allows the serial data rate to be slightly different from the rate set by channels 3 and 4.

Serial Mode Control: There are 6 useful modes (of the possible 8) controlled by bits 4, 5, and 6 of SKCTL. These are described on the next page.

Note that two tone output (bit 3 of SKCTL) may be used in any of these modes except for the bottom pair. This is because channel 2 is used to set the output transmit rate and is therefore not available for one of the two tones.

Note that the output clock rate is identical to the output data rate.



TITLE	POKEY CHIP		
DRAWING NO	CO12294	REV 3	SHEET 19 OF 4

SKCTL (Serial Port Control) (0F): This address writes data into the register that controls the configuration of the serial port, and also the Fast Pot Scan and Keyboard Enable.

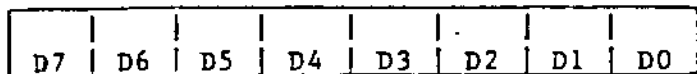

(Bits perform the functions shown below when true.)

D7 Force Break (force serial output to zero (space))*

D6
D5 \ Serial Port Mode Control (see mode chart on next page).
D4 /

D3 Two Tone (Serial output transmitted as two tone signal instead of logic true/false.)

D2 Fast Pot (Fast Pot Scan. The Pot Scan Counter completes its sequence in two TV line times instead of one frame time. The capacitor dump transistors are completely disabled.)

D1 Enable Key Scan (Enables Keyboard Scanning circuit)

D0 Enable Debounce (Enables Keyboard Debounce circuits)

D0-D1 (Both Zero) Initialize (State used for testing and initializing chip)**

*NOTE: When powered on, serial port output may stay low even if this bit is cleared. To get S. P. high (mark), send a byte out (recommend 00 or FF).

**NOTE: There is no original power on state. Pokey has no reset pin.



Serial Mode Control

Force Break

D7 | D6 | D5 | D4 | D3 | D2 | D1 | D0 |

SKCTL REGISTER

Pot scan and keyboard CTRL

Two Tone Control

Mode Control Bits

A = asynchronous

D6	D5	D4	Out Rate	Out Clock	In Rate	Bi-Dir Clock	Comments
0	0	0	ext	ext	ext	ext input	Trans. & Receive rates set by external clock. Also internal clock phase reset to zero.
0	0	1	ext	ext	chan 4 A	ext input	Trans. rate set by external clock. Receive asynch. (ch. 4) (CH3 and CH4)
0	1	0	chan 4	chan 4	chan 4	chan 4 output	Trans. & Receive rates set by Chan. 4. Chan. 4 output on Bi-Directional clock line.
0	1	1	CH4 A	CH4 A	CH4 A	input	Not Useful
1	0	0	chan 4	chan 4	ext	ext input	Trans. Rate Set by Chan. 4 Receive Rate set by External Clock.
1	0	1	CH4 A	CH4 A	CH4 A	input	Not Useful
1	1	0	Chan 2	Chan 2	Chan 2	Chan 4 Output	Trans. rate set by chan. 2 Recieve rate set by chan. 4 Chan. 4 out on Bi-Direct. Clock line.
1	1	1	Chan 2	Chan 2	Chan 4 A	Input not used	Trans. Rate set by Chan. 2. Re-ceive async. (chan 3&4) Bi-Dir. Clock not used (Tri-state condition)

Two tone (bit3) not useable in these modes

II.27



TITLE

POKEY CHIP

DRAWING NO.

COL2294

REV

B

SHEET

21

OF

SKSTAT (Serial Port-Keyboard Status) (0F): This address reads the status register giving information about the serial port and keyboard.

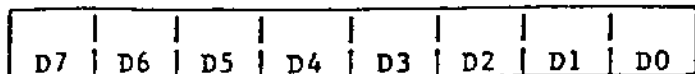

(Bits are normally true and provide the following information when zero.)

- D7 = 0 = Serial Data Input Frame Error
- D6 = 0 = Keyboard Over-run
- D5 = 0 = Serial Data Input Over-run
- D4 = Serial Input PAD SID Pad
- D3 = 0 = Shift Key Depressed
- D2 = 0 = Last Key is Still Depressed
- D1 = 0 = Serial Input Shift Register Busy
- D0 = 1 Not Used (Logic True)

D5 to D7 latches must be reset to 1 by SKRES.

(D5 and D6 are set to zero when new data and same bit of IRQST is zero.)

SKRES (Reset above Status Register) (0A): This write address resets bits 7, 6, and 5 of the Serial Port-Keyboard Status Register to 1.



SERIN (Serial Input Data) (0D): This address reads the 8 bit parallel holding register that is loaded when a full byte of serial input data has been received. This address is usually read in response to a serial data in interrupt (IRQ and bit 5 of IRQST). Also see IRQEN.

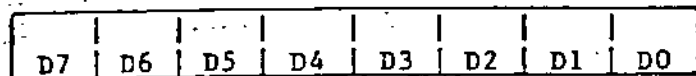

SEROUT (Serial Output Data) (0D): This address writes to the 8 bit parallel holding register that is transferred to the output serial shift register when a full byte of serial output data has been transmitted. This address is usually written in response to a serial data out interrupt (IRQ and bit 4 of IRQST).

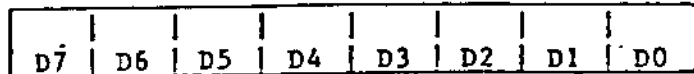

8.) IRQ INTERRUPTS: There are separate IRQ interrupt enable bits for each IRQ interrupt function (bits 0 through 7 of IRQEN). These bits are not initialized by power turn on, and must be initialized by the program before enabling the processor IRQ. The 8 types of IRQ interrupts are:

- D7 = BREAK KEY (depression of the break key)
- D6 = OTHER KEY (depression of any other key)
- D5 = SERIAL INPUT READY (Byte of serial data has been received and is ready to be read by the processor in SERIN register).
- D4 = SERIAL OUTPUT NEEDED (Byte of serial data is being transmitted and SEROUT is ready to be written to again by the processor).
- D3 = TRANSMISSION FINISHED (serial data transmission is finished. Output shift register is empty).
- D2 = TIMER # 4 (audio divider # 4 has counted down to zero)
- D1 = TIMER # 2 (audio divider # 2 has counted down to zero)
- D0 = TIMER # 1 (audio divider # 1 has counted down to zero)

These bits are enabled by bits 0 through 7 of IRQEN and identified by status bits 0 through 7 of IRQST.

The IRQEN register, like the NMIEN register, enables interrupts when its bits are 1 (logic true). The IRQST however (unlike the NMIST) has interrupt status bits that are normally logic true, and go to zero to indicate an interrupt request. The IRQST status bits are returned to logic true only by writing a zero into the corresponding IRQEN bit. This will disable the interrupt and simultaneously set the interrupt status bit to one. Bit 3 of IRQST is not a latch and does not get reset by interrupt disable. It is zero when the serial out is empty (out finished) and true when it is not.



TITLE

POKEY CHIP

DRAWING NO. C012294

REV B

SHEET 23

OF 4

IRQST (IRQ Interrupt Status) (0E): This address reads the data from the IRQ Interrupt Status Register.

0 = Interrupt

1 = No Interrupt

D7	D6	D5	D4	D3	D2	D1	D0
----	----	----	----	----	----	----	----

D7 = 0 Break Key Interrupt

D6 = 0 Other Key Interrupt

D5 = 0 Serial Input Data Ready Interrupt

D4 = 0 Serial Output Data Needed Interrupt

D3 = 0 Serial Output (Byte) Transmission Finished Interrupt *

D2 = 0 Timer 4 Interrupt

D1 = 0 Timer 2 Interrupt

D0 = 0 Timer 1 Interrupt

* - NOTE: Used for generation of 2 stop bits.

IRQEN (IRQ Interrupt Enable) (0E): This address writes data to the IRQ Interrupt Enable bits.

0 = disable, corresponding IRQST bit is set to 1

1 = enable

D7	D6	D5	D4	D3	D2	D1	D0
----	----	----	----	----	----	----	----

D7 Break Key Interrupt Enable

D6 Other Key Interrupt Enable

D5 Serial Input Data Ready Interrupt Enable

D4 Serial Output Data Needed Interrupt Enable

D3 Serial Out Transmission Finished Interrupt Enable

D2 Timer 4 Interrupt Enable

D1 Timer 2 Interrupt Enable

D0 Timer 1 Interrupt Enable



TITLE

POKEY CHIP

DRAWING NO.

CO12294

REV

B

SHEET 24

OF 4

9. ELECTRICAL PARAMETERS

A. General:

- 1.1 Storage Temperature.....-40°C to +90°C
- 1.2 Ambient operating temperature.....0°C to +70°C
- 1.3 Failure rate less than 0.1% per 1000 hours
- 1.4 Maximum voltage range on any pin with respect to VSS
(Pin 1: substrate) without permanent damage to the chip..-0.5V to +9.0V

B. D.C. and Operating Characteristics:

All voltages are referenced to VSS (pin 1). $T_A = 0^\circ\text{C}$ to 70°C .

	MIN.	TYP.	MAX.	UNIT
VCC (PIN 17)	+4.75		+5.25	VOLTS
ICC (PIN 17)			125.0	mA
<u>NORMAL INPUTS:</u>				
SID (PIN 24), $\overline{\text{CS0}}$ (PIN 30), CS1 (PIN 31), A0-A3 (PIN 36-PIN 33), R/W (PIN 32), $\overline{\text{KR1}}$ (PIN 25), $\overline{\text{KR2}}$ (PIN 16)				
V _{IH} INPUT HIGH VOLTAGE:	2.0		VCC	VOLTS
V _{IL} INPUT LOW VOLTAGE:	-0.5		+0.8	VOLTS
I _{LEAKAGE} INPUT LEAKAGE: VIN=7.0 VOLTS			10.0	µA
C _{PIN} PIN CAPACITANCE			7.0	pf
<u>DATA BUS I/O:</u>				
D0-D2 (PIN 38-PIN 40), D3-D7 (PIN 2-PIN 6)				
<u>INPUT:</u>				
V _{IH} INPUT HIGH VOLTAGE:	2.0		VCC	VOLTS
V _{IL} INPUT LOW VOLTAGE:	-0.5		+0.8	VOLTS
I _{LEAKAGE} INPUT LEAKAGE: OUTPUT TRI-STATE VIN=+7.0 VOLTS			10.0	µA
C _{PIN} PIN CAPACITANCE			15.0	pf
<u>OUTPUT:</u>				
V _{OH} OUTPUT HIGH VOLTAGE: I _{LOAD} =-0.1mA	2.4			VOLTS
V _{OL} OUTPUT LOW VOLTAGE: I _{LOAD} =+1.6mA			0.4	VOLTS
C _{LOAD} LOAD CAPACITANCE			130.0	pf



TITLE

POKEY CHIP

DRAWING NO.

CO12294

REV

B

SHEET

25

OF

4

B.) D.C. and Operating Characteristics: (Continued)

B) D.C. AND OPERATING CHARACTERISTICS: (CONT.)

	MIN.	TYP.	MAX.	UNIT
<u>BI-DIRECTIONAL I/O (SCHMITT TRIGGER INPUT):</u>				
ECLK (PIN 26), P0 (PIN 14), P1 (PIN 15), P2 (PIN 12), P3 (PIN 13), P4 (PIN 10), P5 (PIN 11), P6 (PIN 8), P7 (PIN 9)				
<u>INPUT:</u>				
V _{T+} POSITIVE-GOING THRESHOLD VOLTAGE:	1.9		2.6	VOLTS
V _{T-} NEGATIVE-GOING THRESHOLD VOLTAGE:	1.0		2.1	VOLTS
V _{HYS} HYSTERESIS:	0.3			VOLTS
I _{LEAKAGE} INPUT LEAKAGE: VIN=7.0 VOLTS PULL-DOWN IS TURNED OFF			10.0	uA
C _{PIN} PIN CAPACITANCE			7.0	pf
<u>OUTPUT:</u>				
V _{OL} OUTPUT LOW VOLTAGE: I LOAD=+1.6mA			0.4	VOLTS
C _{LOAD} LOAD CAPACITANCE			30.0	pf
<u>OUTPUT (OPEN DRAIN ONLY):</u>				
IRQ (PIN 29), SDD (PIN 28), OCLK (PIN 27)				
V _{OL} OUTPUT LOW VOLTAGE: I LOAD=+1.6mA			0.4	VOLTS
I _{LEAKAGE} INPUT LEAKAGE: VIN=7.0 VOLTS PULL-DOWN IS TURNED OFF			10.0	uA
C _{LOAD} LOAD CAPACITANCE			30.0	pf
<u>INPUT CLOCK :</u>				
BZ (PIN 7)				
V _{IH} INPUT HIGH VOLTAGE:	2.0		VCC	VOLTS
V _{IL} INPUT LOW VOLTAGE:	-0.5		+0.8	VOLTS
I _{LEAKAGE} INPUT LEAKAGE: VIN=7.0 VOLTS			10.0	uA
C _{PIN} PIN CAPACITANCE			14.0	pf
<u>KEYBOARD SCAN OUTPUT:</u>				
K0-K5 (PIN 23-PIN 18)				
V _{OH} OUTPUT HIGH VOLTAGE: I LOAD=-100.0 uA	2.4			VOLTS
V _{OH} OUTPUT HIGH VOLTAGE: I LOAD=-0.0 uA	4.3			VOLTS
V _{OL} OUTPUT LOW VOLTAGE: I LOAD=+1.6mA			0.4	VOLTS
C _{LOAD} LOAD CAPACITANCE			30.0	pf

D.C. and Operating Characteristics: (Continued)

	MIN.	TYP.	MAX.	UNIT
<u>AUDIO OUTPUT (MULTIPLE OPEN DRAIN OUTPUT):</u>				
AUD (PIN 37)				
V_{OL} OUTPUT LOW VOLTAGE: WITH $10K \pm 5\%$ OHM				
FULL UP TO 4.75 Vdc.				
$\frac{10 \text{ micron}}{10 \text{ micron}}$ DEVICE ON ONLY.			4.2	VOLT
$\frac{20 \text{ micron}}{10 \text{ micron}}$ DEVICE ON ONLY.			3.4	VOLT
$\frac{40 \text{ micron}}{10 \text{ micron}}$ DEVICE ON ONLY.			2.1	VOLT
$\frac{80 \text{ micron}}{10 \text{ micron}}$ DEVICE ON ONLY.			1.2	VOLT
V_{OH} OUTPUT HIGH VOLTAGE: WITH $10K \pm 5\%$ OHM				
FULL UP TO 4.75Vdc AND ALL FOUR DEVICES OFF				
	4.2			VOLT
C_{LOAD} LOAD CAPACITANCE			30.0	pf



C.) Dynamic Operating Characteristics:

(VDD = 5V±5% TA = 0° to 70°C)

Parameter	Note	Signal Type	Symbol	MIN.	MAX.	UNI
<u>INPUT TIMING:</u>						
R/W SETUP TIME		BLE	T _{RWS}	130		nS
R/W HOLD TIME		ATE	T _{RWH}	30		nS
ADDRESS SETUP TIME		BLE	T _{ADS}	130		nS
ADDRESS HOLD TIME		ALE	T _{ADH}	30		nS
CHIP SELECT SETUP TIME		BLE	T _{CSS}	50		nS
CHIP SELECT HOLD TIME		ATE	T _{CSH}	30		nS
DATA SETUP TIME : D0-D7		BTE	T _{DSW}	130		nS
DATA HOLD TIME : D0-D7		ATE	T _{DHW}	10		nS
DATA SETUP TIME : $\overline{KR1}, \overline{KR2},$ P0-P7, SID, BCLK		BTE	T _{DS}	150		nS
<u>OUTPUT TIMING:</u>						
DATA SETUP TIME : D0-D7	2	BTE	T _{DSR}	50		nS
DATA HOLD TIME : D0-D7	2	ATE	T _{DHR}	20		nS
DATA DELAY TIME : \overline{IRQ}	1	ALE	T _{DD}		350	nS
DATA DELAY TIME : SOD, BCLK, OCLK	1	ATE	T _{DD}		350	nS
DATA DELAY TIME : AUD	3	ATE	T _{DD}		200	nS
DATA DELAY TIME : $\overline{K0-K5}$	1	ATE	T _{DD}		1.5	uS
DATA DELAY TIME : P0-P7	1	ALE	T _{DD}		1.5	uS

NOTES:

- 1) OUTPUT LOAD AT 30pF + 1 TTL
- 2) OUTPUT LOAD AT 130pF + 1 TTL
- 3) OUTPUT LOAD AT 30pF



D.) Write I/O Timing:

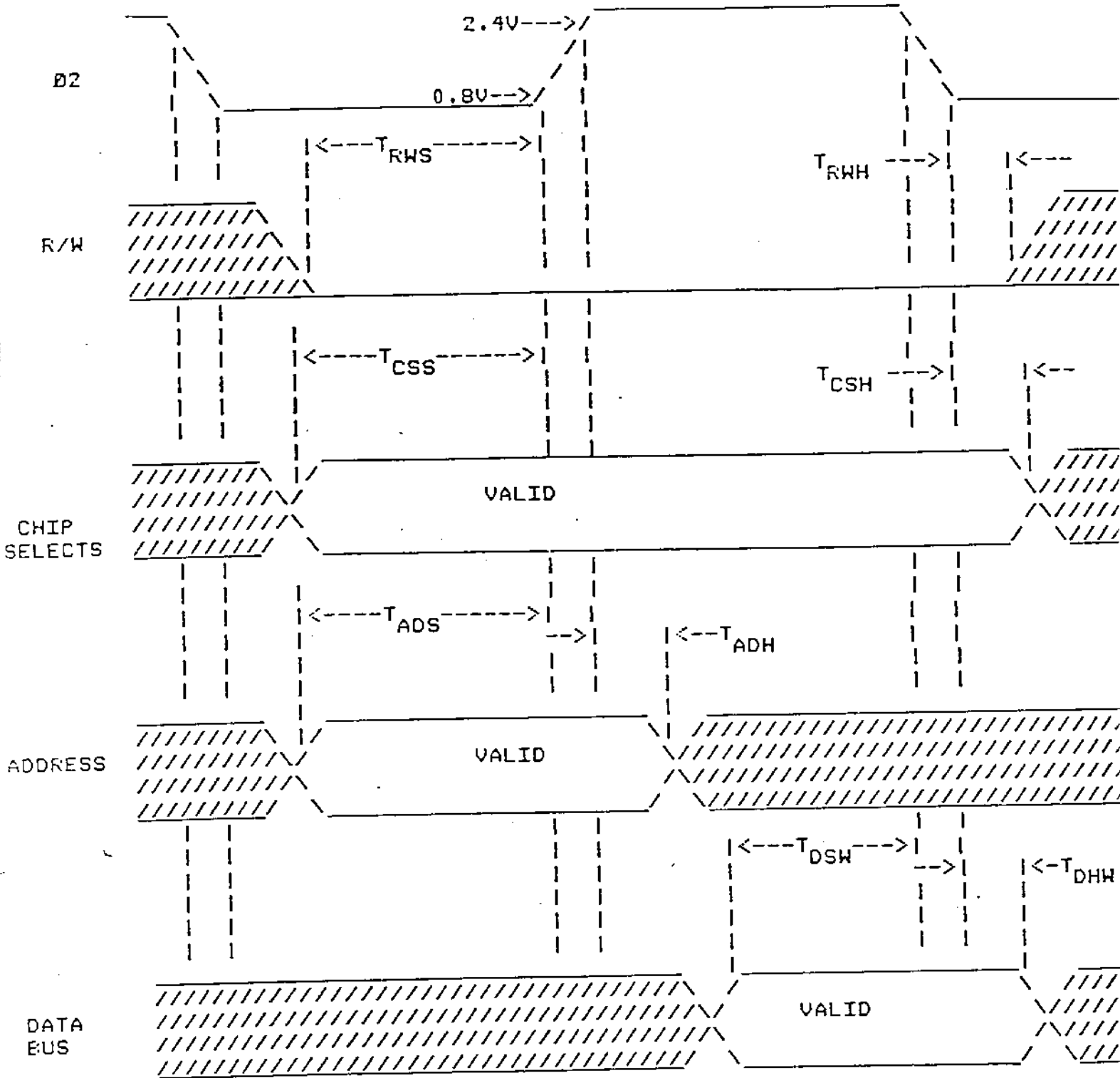

NOTE: ADDRESSES ARE CLOCKED IN ON THE RAISING EDGE OF Ø2.



E.) Read I/O Timing:

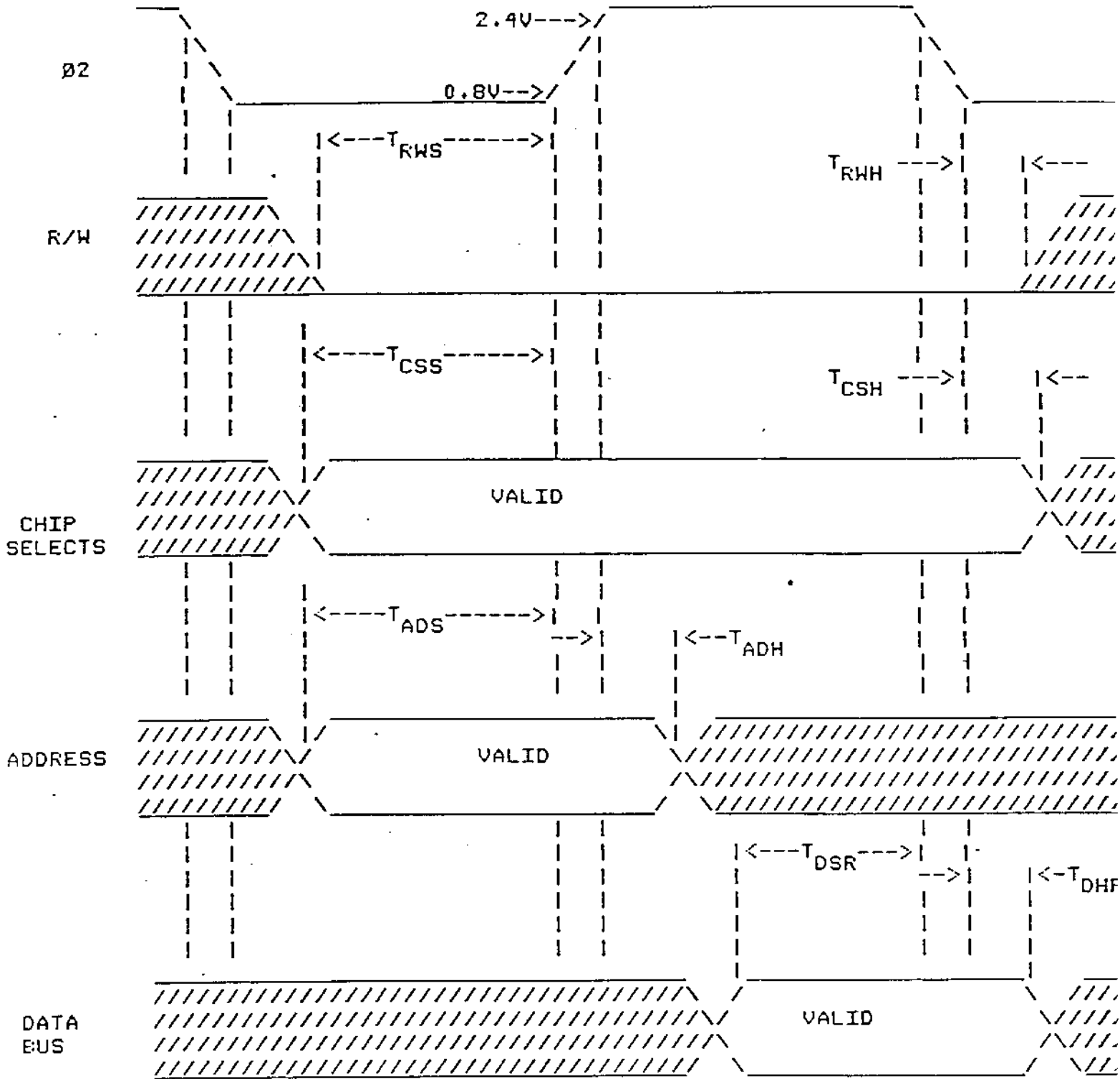

NOTE: ADDRESSES ARE CLOCKED IN ON THE RAISING EDGE OF Ø2.



TITLE	POKEY CHIP		
DRAWING NO.	CO12294	REV	SHEET 30 OF

F. I/O Timing:

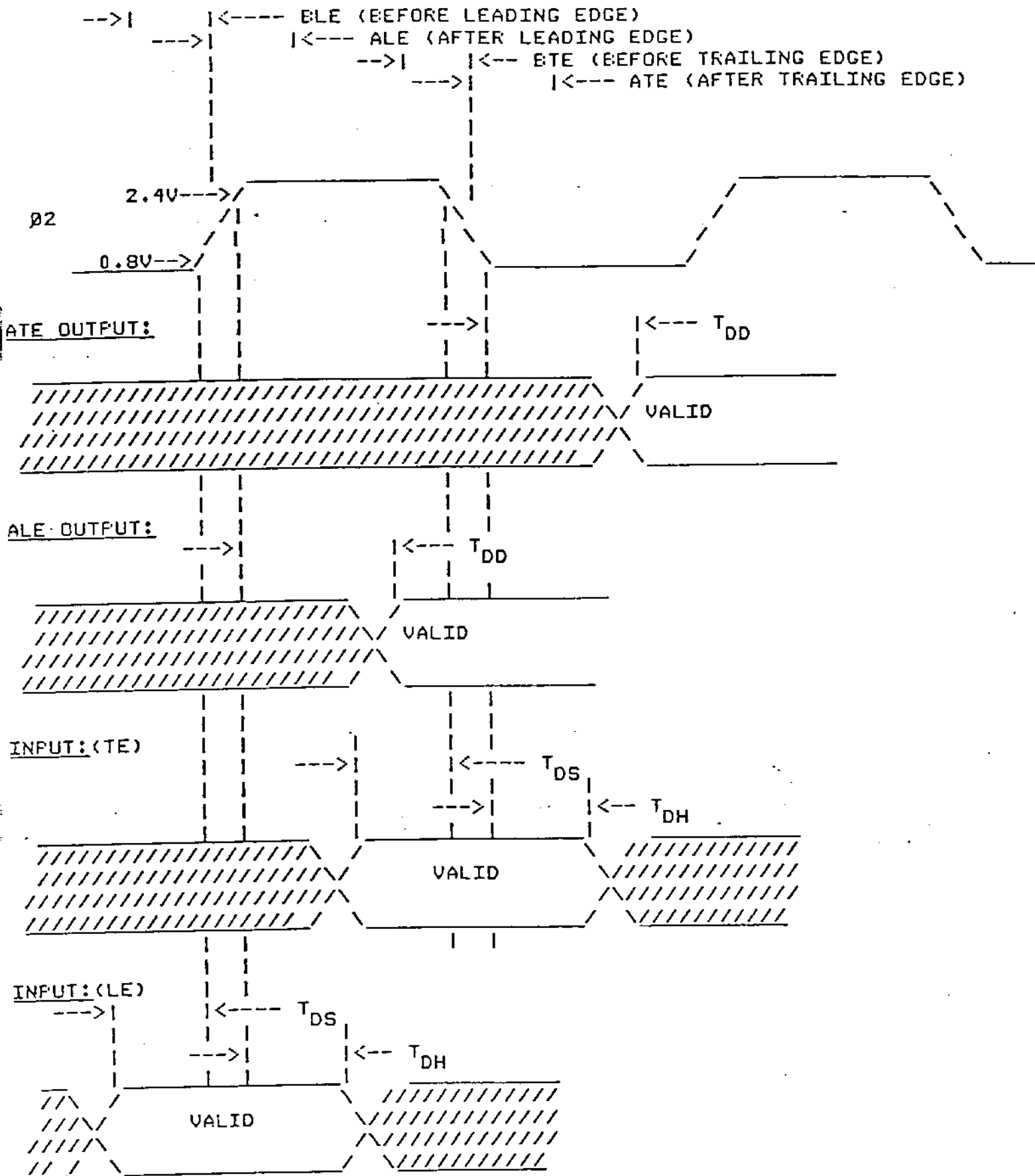

POKEY ADDRESS TABLE:

ADDRESS	WRITE		READ	
	Name	Description	Name	Description
0	AUDF1	Audio Channel 1 Frequency	POT0	Read the value of each pot
1	AUDC1	Audio Channel 1 Control	POT1	
2	AUDF2	Audio Channel 2 Frequency	POT2	
3	AUDC2	Audio Channel 2 Control	POT3	
4	AUDF3	Audio Channel 3 Frequency	POT4	
5	AUDC3	Audio Channel 3 Control	POT5	
6	AUDF4	Audio Channel 4 Frequency	POT6	
7	AUDC4	Audio Channel 4 Control	POT7	
8	AUDCTL	Audio Control	ALLPOT	Read 8 line pot port state
9	STIMER	Start timers	KBCODE	Keyboard code
A	SKRES	Reset Status (SKSTAT)	RANDOM	Random number generator
B	POTGO	Start pot scan sequence		
C				
D	SEROUT	Serial port output register	SERIN	Serial port input register
E	IRQEN	IRQ Interrupt enable	IRQST	IRQ Interrupt status register
F	SKCTLS	Serial port 4 key control	SKSTAT	Serial port 4 key status register



TITLE POKEY CHIP

DRAWING NO. COL2294

REV B

SHEET 32

OF

POKEY PIN LIST:

<u>PACKAGE PIN</u>	<u>NAME</u>	<u>FUNCTION</u>	
1	VSS	Ground	I
2	D3	Data Bus	I/O
3	D4	Data Bus	I/O
4	D5	Data Bus	I/O
5	D6	Data Bus	I/O
6	D7	Data Bus	I/O
7	O2	Phase 2 Clock	I
8	P6	Pot Scan	I
9	P7	Pot Scan	I
10	P4	Pot Scan	I
11	P5	Pot Scan	I
12	P2	Pot Scan	I
13	P3	Pot Scan	I
14	P0	Pot Scan	I
15	P1	Pot Scan	I
16	/KR2	Keyboard Scan	I
17	VDD	5 V Power	I
18	/K5	Keyboard Scan	O
19	/K4	Keyboard Scan	O
20	/K3	Keyboard Scan	O
21	/K2	Keyboard Scan	O
22	/K1	Keyboard Scan	O
23	/K0	Keyboard Scan	O
24	SID	Serial Input Data	I
25	/KR1	Keyboard Scan	I
26	BCLK	Bidirection Clock	I/O
27	OCLK	Serial Output Clock	O
28	SOD	Serial Output Data	O
29	/IRQ	Interrupt Request	O
30	/CS0	Chip Select	I
31	CS1	Chip Select	I
32	R/W	Read/Write Control	I
33	A3	Address Bus	I
34	A2	Address Bus	I
35	A1	Address Bus	I
36	A0	Address Bus	I
37	AUDIO	Audio Out	O
38	DO	Data Bus	I/O
39	D1	Data Bus	I/O
40	D2	Data Bus	I/O



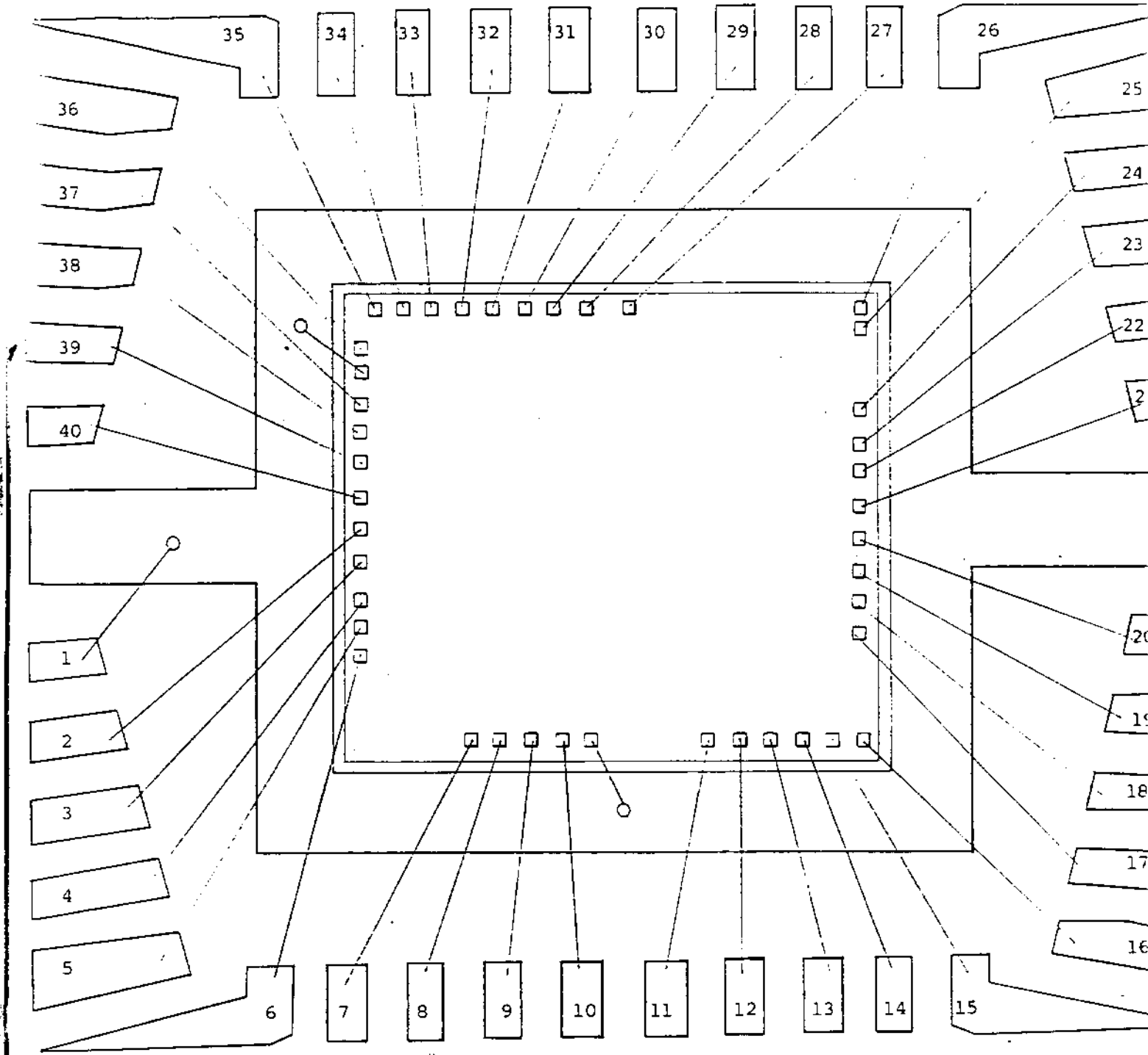

SCALE: 20:1

PACKAGE 204,000-3

DIE SIZE: 179 mils X 159 mils

WIRE BOND: 1.1 mil gold T.C.

DIE ATTACH CAVITY: 210 X 230

COMMENT :

Six Micron Design Rules.

POKEY BONDING DIAGRAM
(Figure 11)

sheet 34 of 41

SYM	REVISIONS	DATE	APPROVED
B	SEE SHEET 1		



POKEY CHIP

DRAWN BY	ENGINEER, MDR.	MATERIAL
CHECKED	QUAL. ASSURANCE	DRAWING NO
ENGINEER	MFG ENGINEER	C012994

SYN	REVISION DESCRIPTION	DATE	APPROVED
	Design Date Updated Package (600)	4/10/82	BN
	Chip + Features (P407)	6/18/82	BN
	Form Changes (P10-B)	7/1/82	BN
	Package (P10-B)	7/1/82	BN
	Package (P10-B)	7/1/82	BN
	Package (P10-B)	7/1/82	BN

Worst Case: Chip Nr Selected
 ADDR XR: 131 (90µs + 600µs) = 9µs
 ADDR XW: 151 (90µs + 416µs) = 7.6µs
 Pi: 4 x 105 = 4.2µs
 R/W, CS1, CS2 = 1.6µs
 Data I/O: 8 x 4 = 31.2µs

CO12294
 35
 8

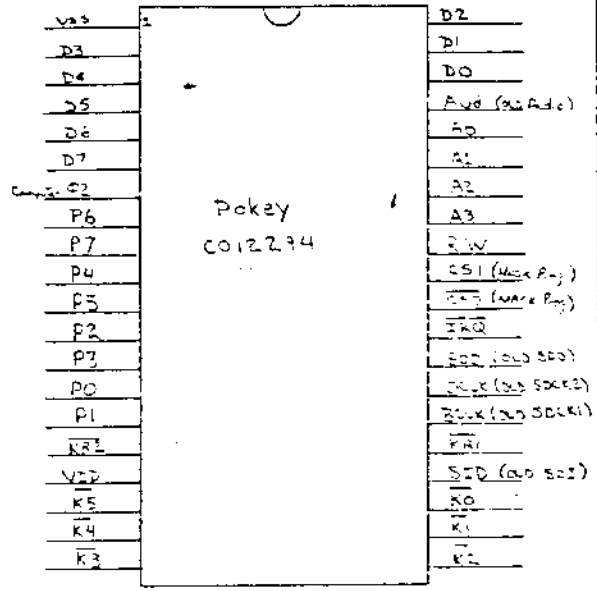
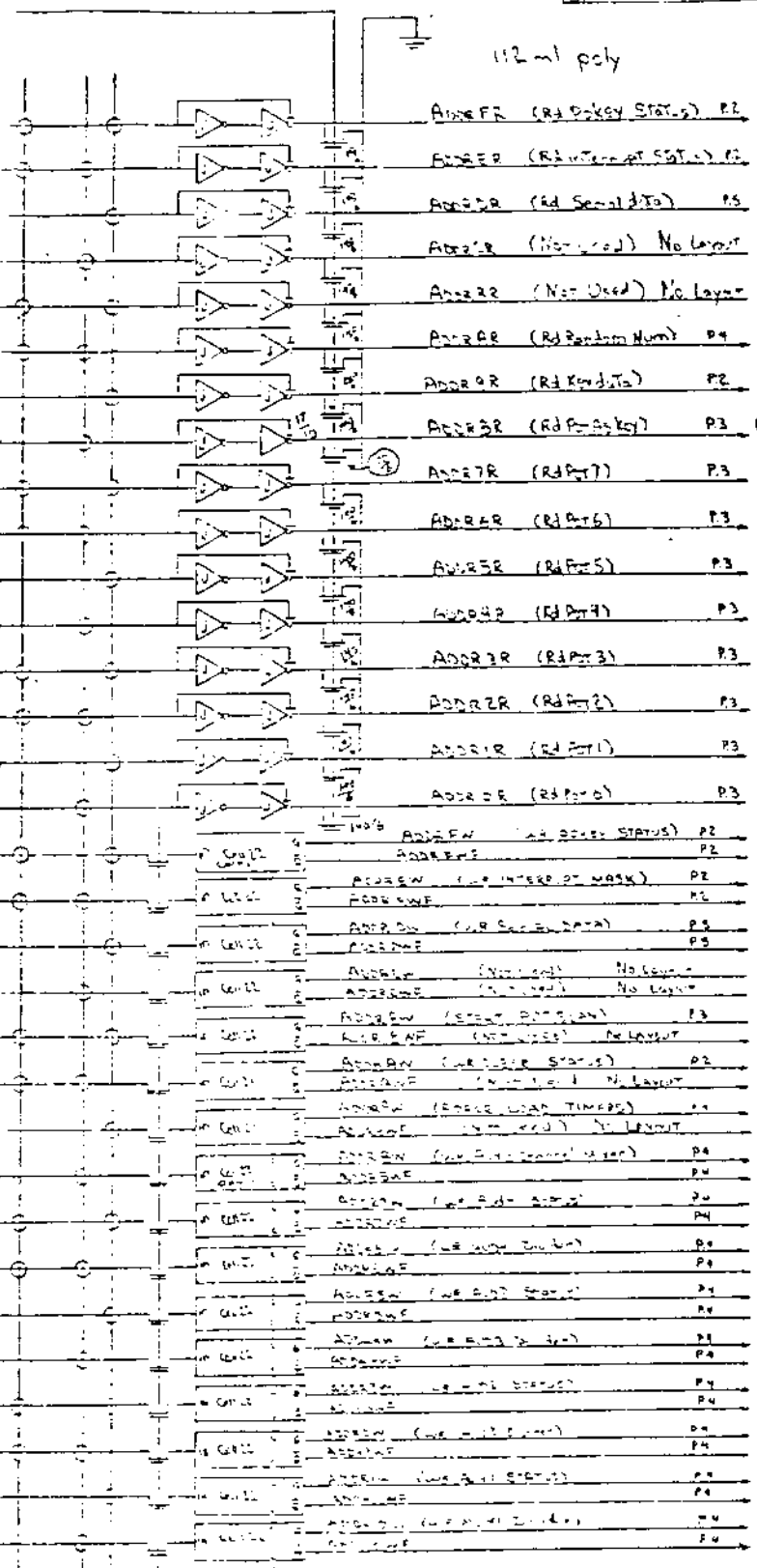

CONFIDENTIAL

OUTSTANDING ECNs	

UNLESS OTHERWISE SPECIFIED DIMENSIONS ARE IN INCHES TOLERANCES ON ANGLES ±1° FINISHES UNLESS OTHERWISE SPECIFIED	DO NOT SCALE DRAWING	Atari Inc. 12855 Borregat Avenue Sunnyvale, Calif. 94086
	DRAWN BY: _____ DATE: _____ CHECKED: _____ ENGINEER: _____ PROJECT ENGINEER: _____ MFG ENGINEER: _____	
MATERIAL Chip Total 20.3 mg 170 µm	ALL DRAWING NO. D CO12294 6437	DATE 1982 3/11

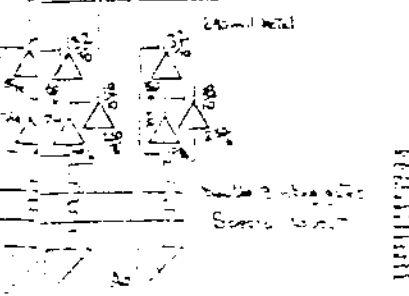

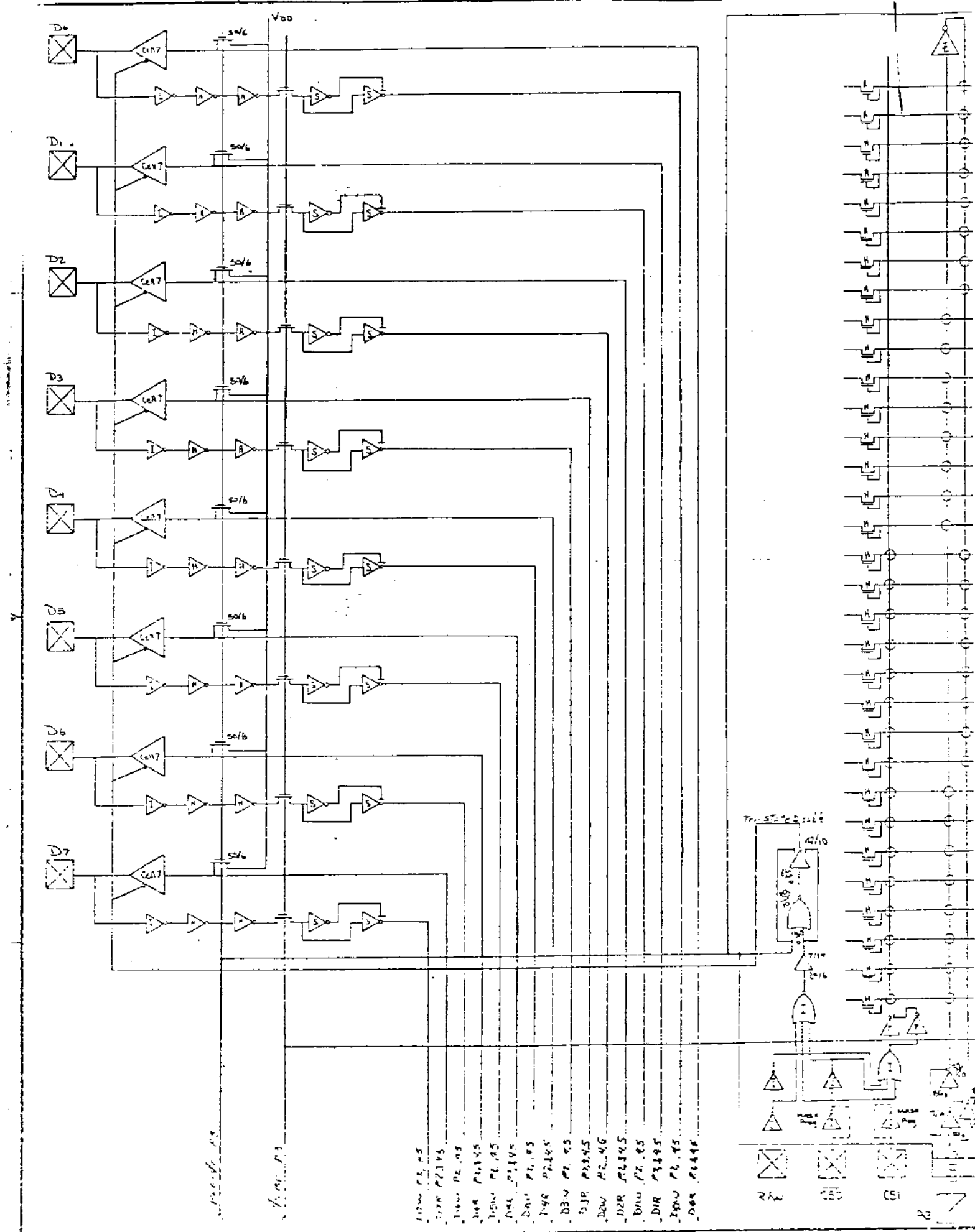

8

7

6

5

- 1000 P2.05
- 1001 P2.05
- 1002 P2.05
- 1003 P2.05
- 1004 P2.05
- 1005 P2.05
- 1006 P2.05
- 1007 P2.05
- 1008 P2.05
- 1009 P2.05
- 1010 P2.05
- 1011 P2.05
- 1012 P2.05
- 1013 P2.05
- 1014 P2.05
- 1015 P2.05
- 1016 P2.05
- 1017 P2.05
- 1018 P2.05
- 1019 P2.05
- 1020 P2.05
- 1021 P2.05
- 1022 P2.05
- 1023 P2.05
- 1024 P2.05
- 1025 P2.05
- 1026 P2.05
- 1027 P2.05
- 1028 P2.05
- 1029 P2.05
- 1030 P2.05
- 1031 P2.05
- 1032 P2.05
- 1033 P2.05
- 1034 P2.05
- 1035 P2.05
- 1036 P2.05
- 1037 P2.05
- 1038 P2.05
- 1039 P2.05
- 1040 P2.05
- 1041 P2.05
- 1042 P2.05
- 1043 P2.05
- 1044 P2.05
- 1045 P2.05
- 1046 P2.05
- 1047 P2.05
- 1048 P2.05
- 1049 P2.05
- 1050 P2.05
- 1051 P2.05
- 1052 P2.05
- 1053 P2.05
- 1054 P2.05
- 1055 P2.05
- 1056 P2.05
- 1057 P2.05
- 1058 P2.05
- 1059 P2.05
- 1060 P2.05
- 1061 P2.05
- 1062 P2.05
- 1063 P2.05
- 1064 P2.05
- 1065 P2.05
- 1066 P2.05
- 1067 P2.05
- 1068 P2.05
- 1069 P2.05
- 1070 P2.05
- 1071 P2.05
- 1072 P2.05
- 1073 P2.05
- 1074 P2.05
- 1075 P2.05
- 1076 P2.05
- 1077 P2.05
- 1078 P2.05
- 1079 P2.05
- 1080 P2.05
- 1081 P2.05
- 1082 P2.05
- 1083 P2.05
- 1084 P2.05
- 1085 P2.05
- 1086 P2.05
- 1087 P2.05
- 1088 P2.05
- 1089 P2.05
- 1090 P2.05
- 1091 P2.05
- 1092 P2.05
- 1093 P2.05
- 1094 P2.05
- 1095 P2.05
- 1096 P2.05
- 1097 P2.05
- 1098 P2.05
- 1099 P2.05
- 1100 P2.05
- 1101 P2.05
- 1102 P2.05
- 1103 P2.05
- 1104 P2.05
- 1105 P2.05
- 1106 P2.05
- 1107 P2.05
- 1108 P2.05
- 1109 P2.05
- 1110 P2.05
- 1111 P2.05
- 1112 P2.05
- 1113 P2.05
- 1114 P2.05
- 1115 P2.05
- 1116 P2.05
- 1117 P2.05
- 1118 P2.05
- 1119 P2.05
- 1120 P2.05
- 1121 P2.05
- 1122 P2.05
- 1123 P2.05
- 1124 P2.05
- 1125 P2.05
- 1126 P2.05
- 1127 P2.05
- 1128 P2.05
- 1129 P2.05
- 1130 P2.05
- 1131 P2.05
- 1132 P2.05
- 1133 P2.05
- 1134 P2.05
- 1135 P2.05
- 1136 P2.05
- 1137 P2.05
- 1138 P2.05
- 1139 P2.05
- 1140 P2.05
- 1141 P2.05
- 1142 P2.05
- 1143 P2.05
- 1144 P2.05
- 1145 P2.05
- 1146 P2.05
- 1147 P2.05
- 1148 P2.05
- 1149 P2.05
- 1150 P2.05
- 1151 P2.05
- 1152 P2.05
- 1153 P2.05
- 1154 P2.05
- 1155 P2.05
- 1156 P2.05
- 1157 P2.05
- 1158 P2.05
- 1159 P2.05
- 1160 P2.05
- 1161 P2.05
- 1162 P2.05
- 1163 P2.05
- 1164 P2.05
- 1165 P2.05
- 1166 P2.05
- 1167 P2.05
- 1168 P2.05
- 1169 P2.05
- 1170 P2.05
- 1171 P2.05
- 1172 P2.05
- 1173 P2.05
- 1174 P2.05
- 1175 P2.05
- 1176 P2.05
- 1177 P2.05
- 1178 P2.05
- 1179 P2.05
- 1180 P2.05
- 1181 P2.05
- 1182 P2.05
- 1183 P2.05
- 1184 P2.05
- 1185 P2.05
- 1186 P2.05
- 1187 P2.05
- 1188 P2.05
- 1189 P2.05
- 1190 P2.05
- 1191 P2.05
- 1192 P2.05
- 1193 P2.05
- 1194 P2.05
- 1195 P2.05
- 1196 P2.05
- 1197 P2.05
- 1198 P2.05
- 1199 P2.05
- 1200 P2.05
- 1201 P2.05
- 1202 P2.05
- 1203 P2.05
- 1204 P2.05
- 1205 P2.05
- 1206 P2.05
- 1207 P2.05
- 1208 P2.05
- 1209 P2.05
- 1210 P2.05
- 1211 P2.05
- 1212 P2.05
- 1213 P2.05
- 1214 P2.05
- 1215 P2.05
- 1216 P2.05
- 1217 P2.05
- 1218 P2.05
- 1219 P2.05
- 1220 P2.05
- 1221 P2.05
- 1222 P2.05
- 1223 P2.05
- 1224 P2.05
- 1225 P2.05
- 1226 P2.05
- 1227 P2.05
- 1228 P2.05
- 1229 P2.05
- 1230 P2.05
- 1231 P2.05
- 1232 P2.05
- 1233 P2.05
- 1234 P2.05
- 1235 P2.05
- 1236 P2.05
- 1237 P2.05
- 1238 P2.05
- 1239 P2.05
- 1240 P2.05
- 1241 P2.05
- 1242 P2.05
- 1243 P2.05
- 1244 P2.05
- 1245 P2.05
- 1246 P2.05
- 1247 P2.05
- 1248 P2.05
- 1249 P2.05
- 1250 P2.05
- 1251 P2.05
- 1252 P2.05
- 1253 P2.05
- 1254 P2.05
- 1255 P2.05
- 1256 P2.05
- 1257 P2.05
- 1258 P2.05
- 1259 P2.05
- 1260 P2.05
- 1261 P2.05
- 1262 P2.05
- 1263 P2.05
- 1264 P2.05
- 1265 P2.05
- 1266 P2.05
- 1267 P2.05
- 1268 P2.05
- 1269 P2.05
- 1270 P2.05
- 1271 P2.05
- 1272 P2.05
- 1273 P2.05
- 1274 P2.05
- 1275 P2.05
- 1276 P2.05
- 1277 P2.05
- 1278 P2.05
- 1279 P2.05
- 1280 P2.05
- 1281 P2.05
- 1282 P2.05
- 1283 P2.05
- 1284 P2.05
- 1285 P2.05
- 1286 P2.05
- 1287 P2.05
- 1288 P2.05
- 1289 P2.05
- 1290 P2.05
- 1291 P2.05
- 1292 P2.05
- 1293 P2.05
- 1294 P2.05
- 1295 P2.05
- 1296 P2.05
- 1297 P2.05
- 1298 P2.05
- 1299 P2.05
- 1300 P2.05
- 1301 P2.05
- 1302 P2.05
- 1303 P2.05
- 1304 P2.05
- 1305 P2.05
- 1306 P2.05
- 1307 P2.05
- 1308 P2.05
- 1309 P2.05
- 1310 P2.05
- 1311 P2.05
- 1312 P2.05
- 1313 P2.05
- 1314 P2.05
- 1315 P2.05
- 1316 P2.05
- 1317 P2.05
- 1318 P2.05
- 1319 P2.05
- 1320 P2.05
- 1321 P2.05
- 1322 P2.05
- 1323 P2.05
- 1324 P2.05
- 1325 P2.05
- 1326 P2.05
- 1327 P2.05
- 1328 P2.05
- 1329 P2.05
- 1330 P2.05
- 1331 P2.05
- 1332 P2.05
- 1333 P2.05
- 1334 P2.05
- 1335 P2.05
- 1336 P2.05
- 1337 P2.05
- 1338 P2.05
- 1339 P2.05
- 1340 P2.05
- 1341 P2.05
- 1342 P2.05
- 1343 P2.05
- 1344 P2.05
- 1345 P2.05
- 1346 P2.05
- 1347 P2.05
- 1348 P2.05
- 1349 P2.05
- 1350 P2.05
- 1351 P2.05
- 1352 P2.05
- 1353 P2.05
- 1354 P2.05
- 1355 P2.05
- 1356 P2.05
- 1357 P2.05
- 1358 P2.05
- 1359 P2.05
- 1360 P2.05
- 1361 P2.05
- 1362 P2.05
- 1363 P2.05
- 1364 P2.05
- 1365 P2.05
- 1366 P2.05
- 1367 P2.05
- 1368 P2.05
- 1369 P2.05
- 1370 P2.05
- 1371 P2.05
- 1372 P2.05
- 1373 P2.05
- 1374 P2.05
- 1375 P2.05
- 1376 P2.05
- 1377 P2.05
- 1378 P2.05
- 1379 P2.05
- 1380 P2.05
- 1381 P2.05
- 1382 P2.05
- 1383 P2.05
- 1384 P2.05
- 1385 P2.05
- 1386 P2.05
- 1387 P2.05
- 1388 P2.05
- 1389 P2.05
- 1390 P2.05
- 1391 P2.05
- 1392 P2.05
- 1393 P2.05
- 1394 P2.05
- 1395 P2.05
- 1396 P2.05
- 1397 P2.05
- 1398 P2.05
- 1399 P2.05
- 1400 P2.05
- 1401 P2.05
- 1402 P2.05
- 1403 P2.05
- 1404 P2.05
- 1405 P2.05
- 1406 P2.05
- 1407 P2.05
- 1408 P2.05
- 1409 P2.05
- 1410 P2.05
- 1411 P2.05
- 1412 P2.05
- 1413 P2.05
- 1414 P2.05
- 1415 P2.05
- 1416 P2.05
- 1417 P2.05
- 1418 P2.05
- 1419 P2.05
- 1420 P2.05
- 1421 P2.05
- 1422 P2.05
- 1423 P2.05
- 1424 P2.05
- 1425 P2.05
- 1426 P2.05
- 1427 P2.05
- 1428 P2.05
- 1429 P2.05
- 1430 P2.05
- 1431 P2.05
- 1432 P2.05
- 1433 P2.05
- 1434 P2.05
- 1435 P2.05
- 1436 P2.05
- 1437 P2.05
- 1438 P2.05
- 1439 P2.05
- 1440 P2.05
- 1441 P2.05
- 1442 P2.05
- 1443 P2.05
- 1444 P2.05
- 1445 P2.05
- 1446 P2.05
- 1447 P2.05
- 1448 P2.05
- 1449 P2.05
- 1450 P2.05
- 1451 P2.05
- 1452 P2.05
- 1453 P2.05
- 1454 P2.05
- 1455 P2.05
- 1456 P2.05
- 1457 P2.05
- 1458 P2.05
- 1459 P2.05
- 1460 P2.05
- 1461 P2.05
- 1462 P2.05
- 1463 P2.05
- 1464 P2.05
- 1465 P2.05
- 1466 P2.05
- 1467 P2.05
- 1468 P2.05
- 1469 P2.05
- 1470 P2.05
- 1471 P2.05
- 1472 P2.05
- 1473 P2.05
- 1474 P2.05
- 1475 P2.05
- 1476 P2.05
- 1477 P2.05
- 1478 P2.05
- 1479 P2.05
- 1480 P2.05
- 1481 P2.05
- 1482 P2.05
- 1483 P2.05
- 1484 P2.05
- 1485 P2.05
- 1486 P2.05
- 1487 P2.05
- 1488 P2.05
- 1489 P2.05
- 1490 P2.05
- 1491 P2.05
- 1492 P2.05
- 1493 P2.05
- 1494 P2.05
- 1495 P2.05
- 1496 P2.05
- 1497 P2.05
- 1498 P2.05
- 1499 P2.05
- 1500 P2.05

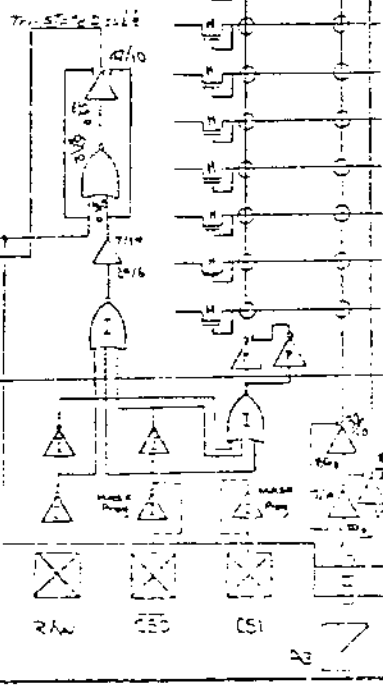

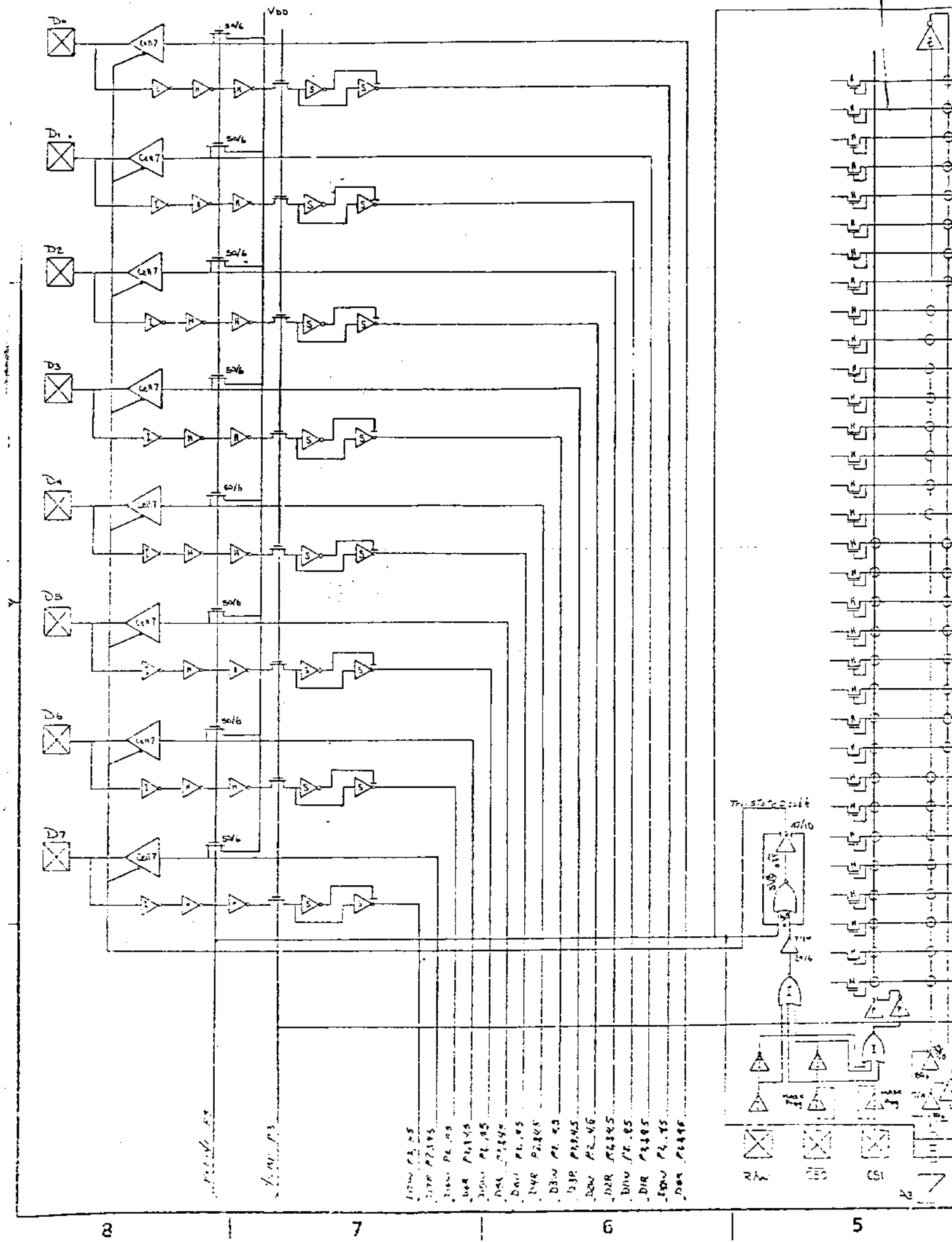

- D100 P2.05
- D101 P2.05
- D102 P2.05
- D103 P2.05
- D104 P2.05
- D105 P2.05
- D106 P2.05
- D107 P2.05
- D108 P2.05
- D109 P2.05
- D110 P2.05
- D111 P2.05
- D112 P2.05
- D113 P2.05
- D114 P2.05
- D115 P2.05
- D116 P2.05
- D117 P2.05
- D118 P2.05
- D119 P2.05
- D120 P2.05

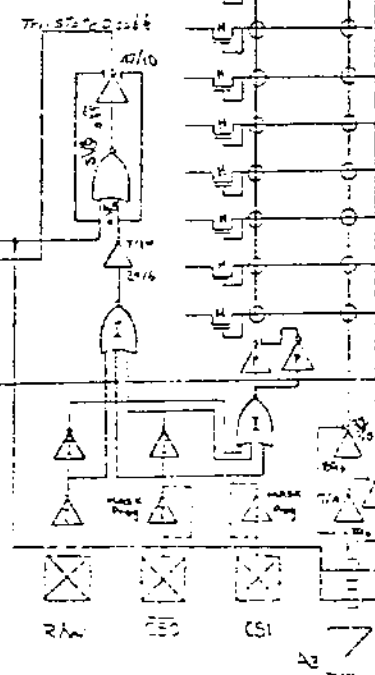

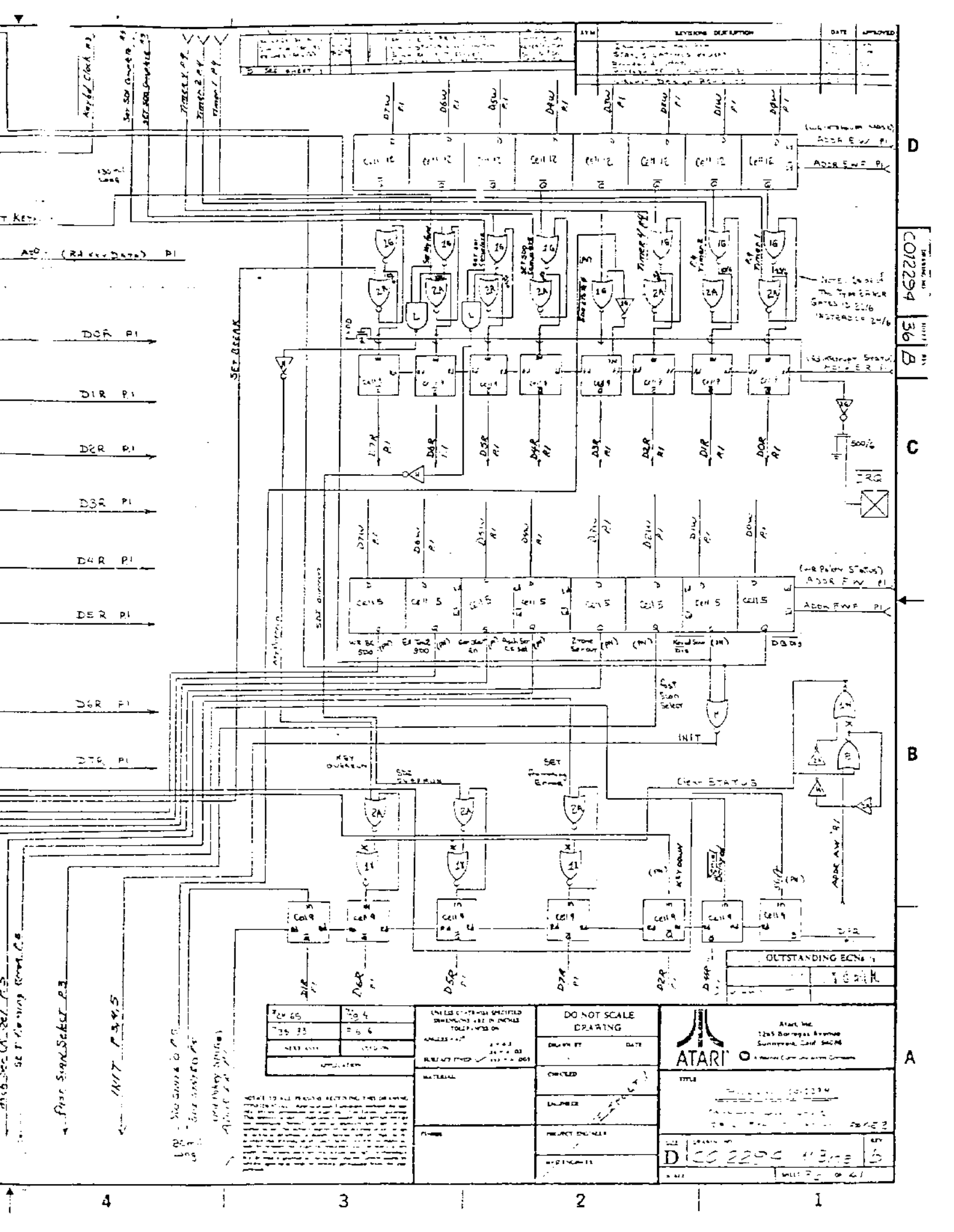

CO12294

36

C

B

A

ATM	REVISION	DESCRIPTION	DATE	APPROVED

REV 05	REV 04
REV 03	REV 02
REV 01	REV 00

UNLESS OTHERWISE SPECIFIED
DIMENSIONS ARE IN INCHES
TOLERANCES ARE:

ANGLES ± 1°
HOLE POSITION ± 0.010
HOLE DIA ± 0.010

MATERIAL:

FINISH:

DO NOT SCALE
DRAWING

DRAWN BY: DATE:

CHECKED:

INCHES:

FRONT OR REAR:

BY: DATE:

ATARI

Atari, Inc.
1245 Borregas Avenue
Sunnyvale, Calif. 94086

A Division of Commodore International

OUTSTANDING ECNs	
NO.	DATE

TITLE: CO12294

DATE: 11/18/83

BY: D

REV: 05

FILE: CO12294

WILL P. O. 41

4

3

2

1

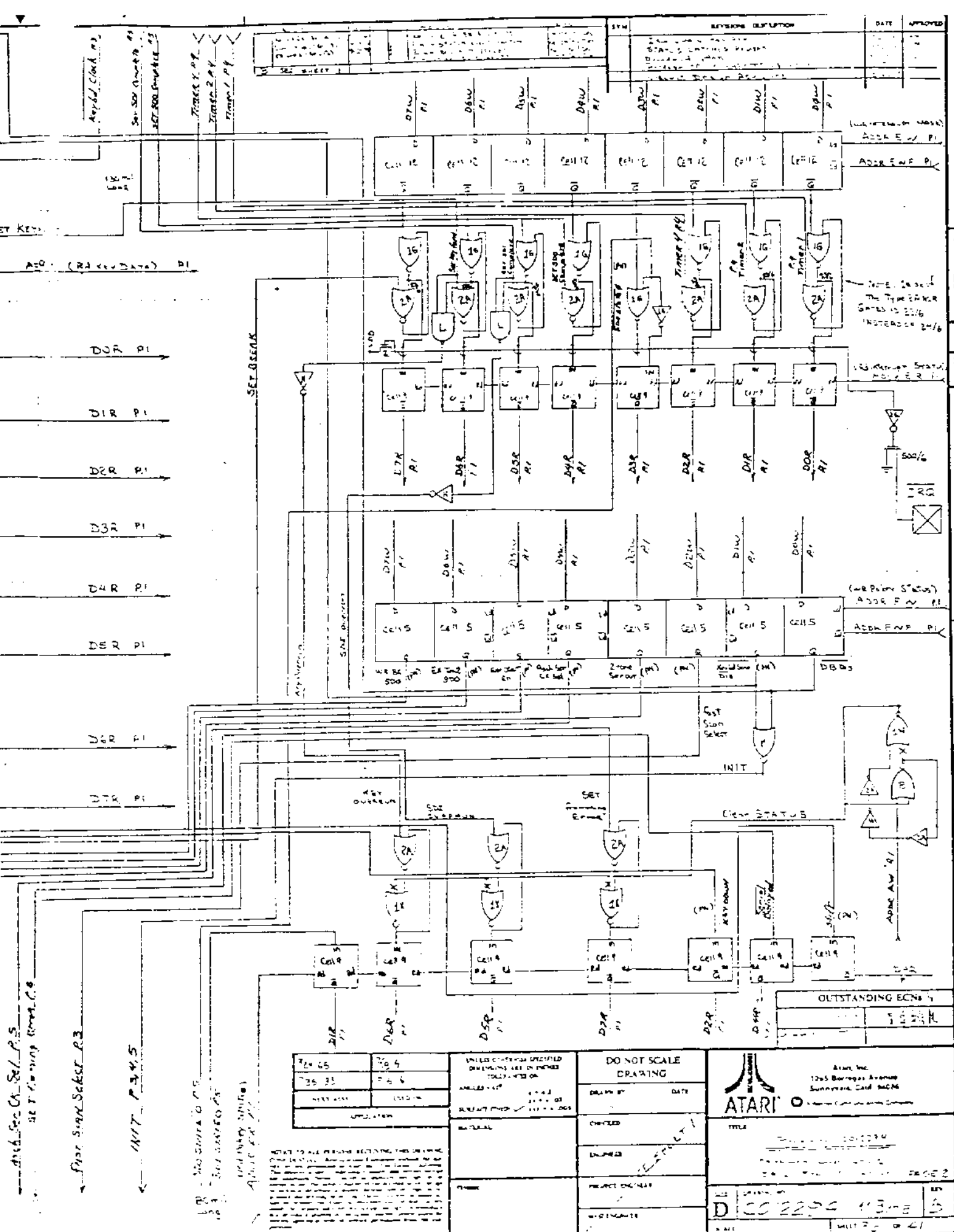

REV	REVISION DESCRIPTION	DATE	APPROVED
1	INITIAL DESIGN		
2	REVISED FOR BOARD LAYOUT		
3	REVISED FOR BOARD LAYOUT		
4	REVISED FOR BOARD LAYOUT		

CO12294

36 B

C

B

A

24 65	24 65
26 25	26 25
REVISED	REVISED
APPROVED	APPROVED

UNLESS OTHERWISE SPECIFIED
DIMENSIONS ARE IN INCHES
TOLERANCES ARE:

DO NOT SCALE
DRAWING

ATARI logo
Atari, Inc.
1205 Borregas Avenue
Sunnyvale, Calif. 94086

REVISIONS
1. INITIAL DESIGN
2. REVISED FOR BOARD LAYOUT
3. REVISED FOR BOARD LAYOUT
4. REVISED FOR BOARD LAYOUT

DATE: 11/10/83
DRAWN BY: [Name]
CHECKED BY: [Name]
DESIGNED BY: [Name]
PROJECT ENGINEER: [Name]
MANUFACTURED BY: [Name]

DATE: 11/10/83
DRAWN BY: [Name]
CHECKED BY: [Name]
DESIGNED BY: [Name]
PROJECT ENGINEER: [Name]
MANUFACTURED BY: [Name]

OUTSTANDING ECNs

NO.	DATE	DESCRIPTION

CO12294 13-B 36
11/10/83

INIT - P. 3, 4, 5
SAFE PROMS
MIRROR PROMS

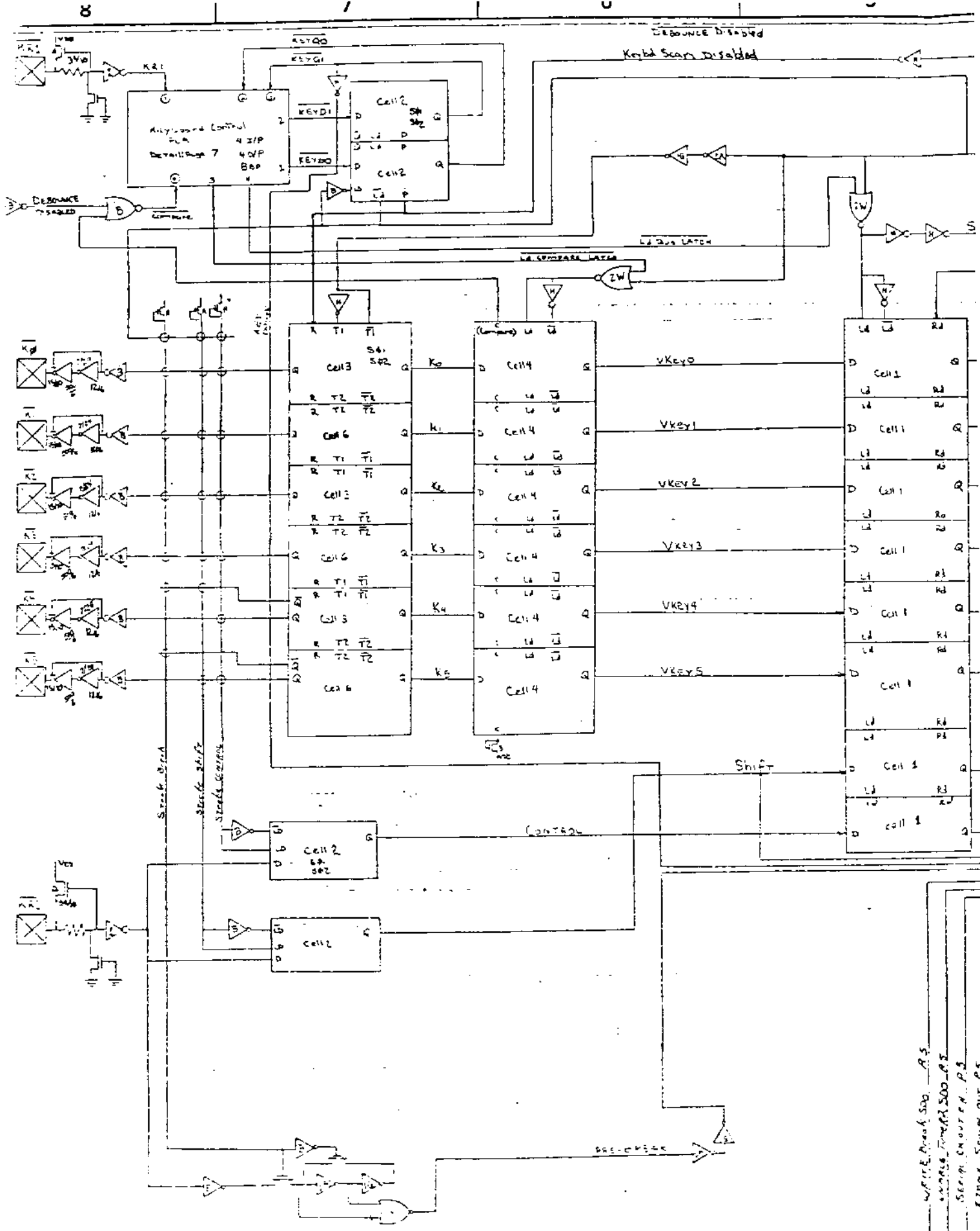

WRITE, READ, SER. IN, SER. OUT, P.S.
 ADDRESS, TEMP, SER. IN, SER. OUT, P.S.
 SERIAL IN, SERIAL OUT, P.S.
 TEMP, SER. IN, SER. OUT, P.S.

SYN	REV	DATE	BY
1	1	10/10/77	...
2	1	10/10/77	...
3	1	10/10/77	...
4	1	10/10/77	...

Clock generation
Default: Page 7

Computer ϕ_2

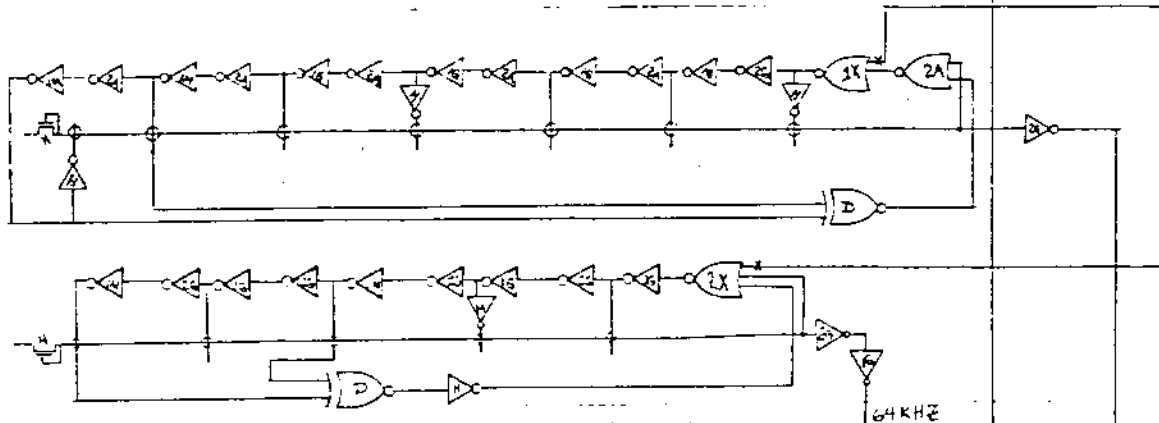

64KHz

45VDC

CONFIDENTIAL

OUTSTANDING ECNs	

DATE	BY	REVISION
10/10/77	...	1

UNLESS OTHERWISE SPECIFIED
DIMENSIONS ARE IN INCHES
TOLERANCES ON

DO NOT SCALE
DRAWING

DESIGNED BY: [Signature]
DATE: 10/10/77
CHECKED BY: [Signature]
PROJECT ENGINEER: [Signature]
MATERIAL: [Blank]
FINISH: [Blank]

ATARI
Atari, Inc.
1285 Burrage Avenue
Sunnyvale, Calif. 94088

NOTE TO ALL PERSONS RECEIVING THIS DRAWING:
This drawing is the property of Atari, Inc. and is to be used only for the project and purpose for which it was prepared. It is not to be distributed, copied, or used in any way without the express written consent of Atari, Inc. All information contained herein is confidential and proprietary to Atari, Inc. and is to be held in strict confidence. This drawing is to be returned to Atari, Inc. upon completion of the project or upon demand.

TITLE	Page 3 of 3
DATE	10/10/77
BY	...
REV	3

Fast Scan Select

PRC Per Clock

ADDA Bw P1
(3.725 + 400.000)

Number Clock P1

PRC P1

ADDA Bw P1

CO12294

37

B

C

B

A

4

3

2

1

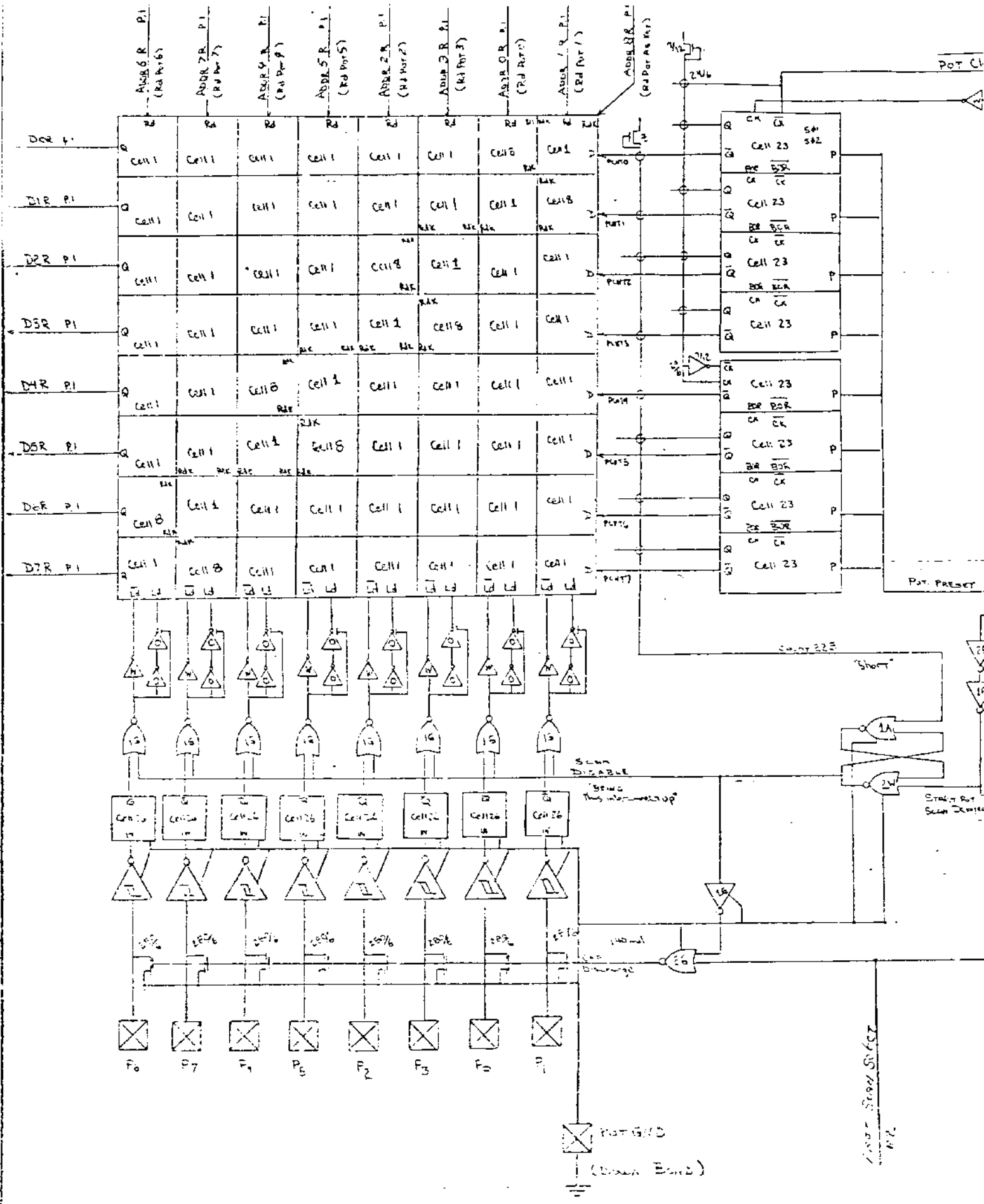

8

7

6

5

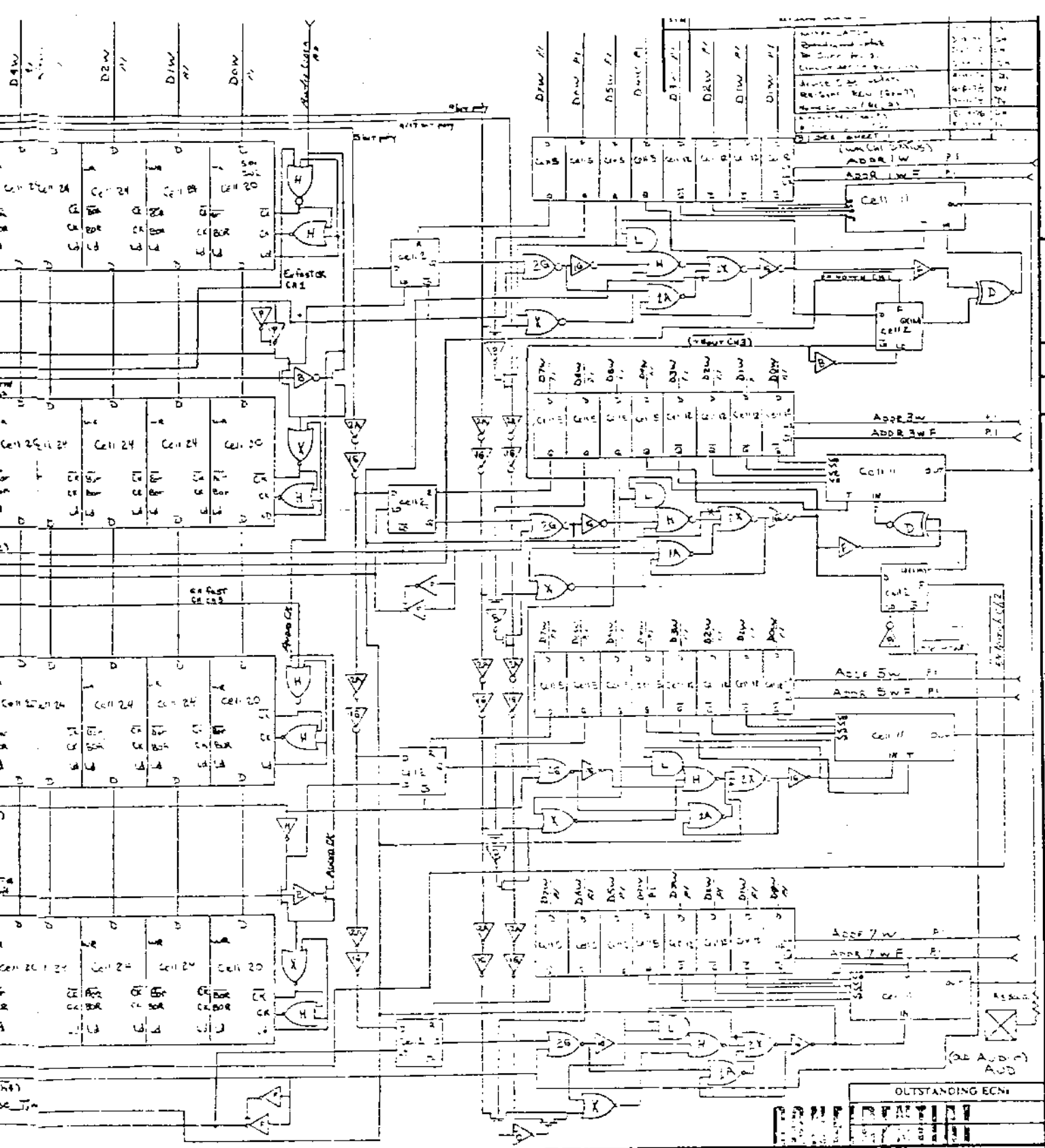

D
 COL2294 38 B
 C
 B
 A

35 74	75 74
76 74	77 74
78 74	79 74
80 74	81 74
82 74	83 74
84 74	85 74
86 74	87 74
88 74	89 74
90 74	91 74
92 74	93 74
94 74	95 74
96 74	97 74
98 74	99 74
100 74	101 74

UNLESS OTHERWISE SPECIFIED
 DIMENSIONS ARE IN INCHES
 TOLERANCES ON
 ANGLES ± .1°
 SURFACE FINISH
 MATERIAL
 FINISH

DO NOT SCALE DRAWING
 DRAWN BY _____ DATE _____
 CHECKED _____
 ENGINEER _____
 PROJECT NUMBER _____
 FILE NUMBER _____

OUTSTANDING ECNs: _____
ATARI
 Atari, Inc.
 1265 Borregas Avenue
 Sunnyvale, Calif. 94086
 TITLE: _____
 PART NUMBER: COL2294 38 B
 CASE: C

4
 3
 2
 1

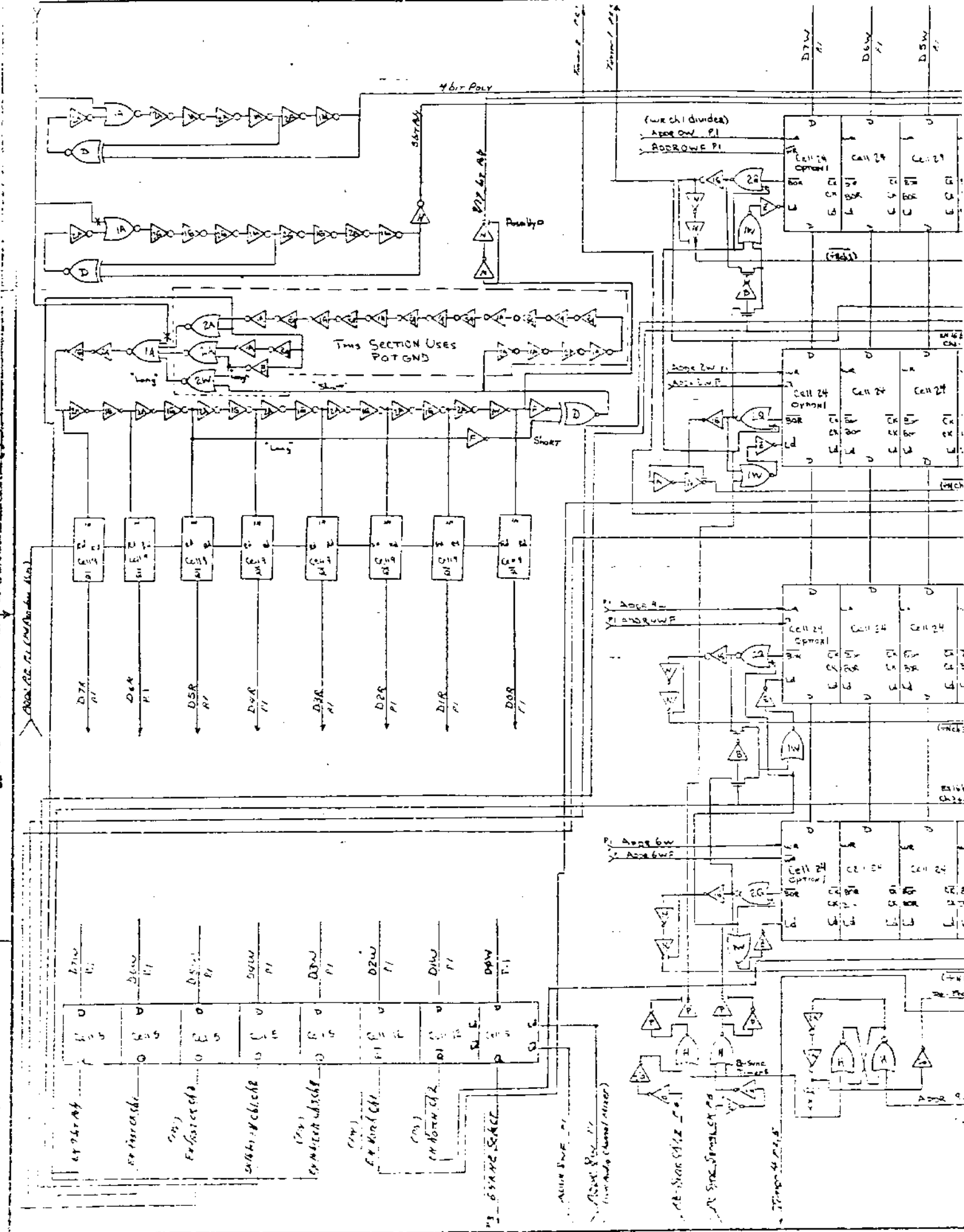

8

7

6

5

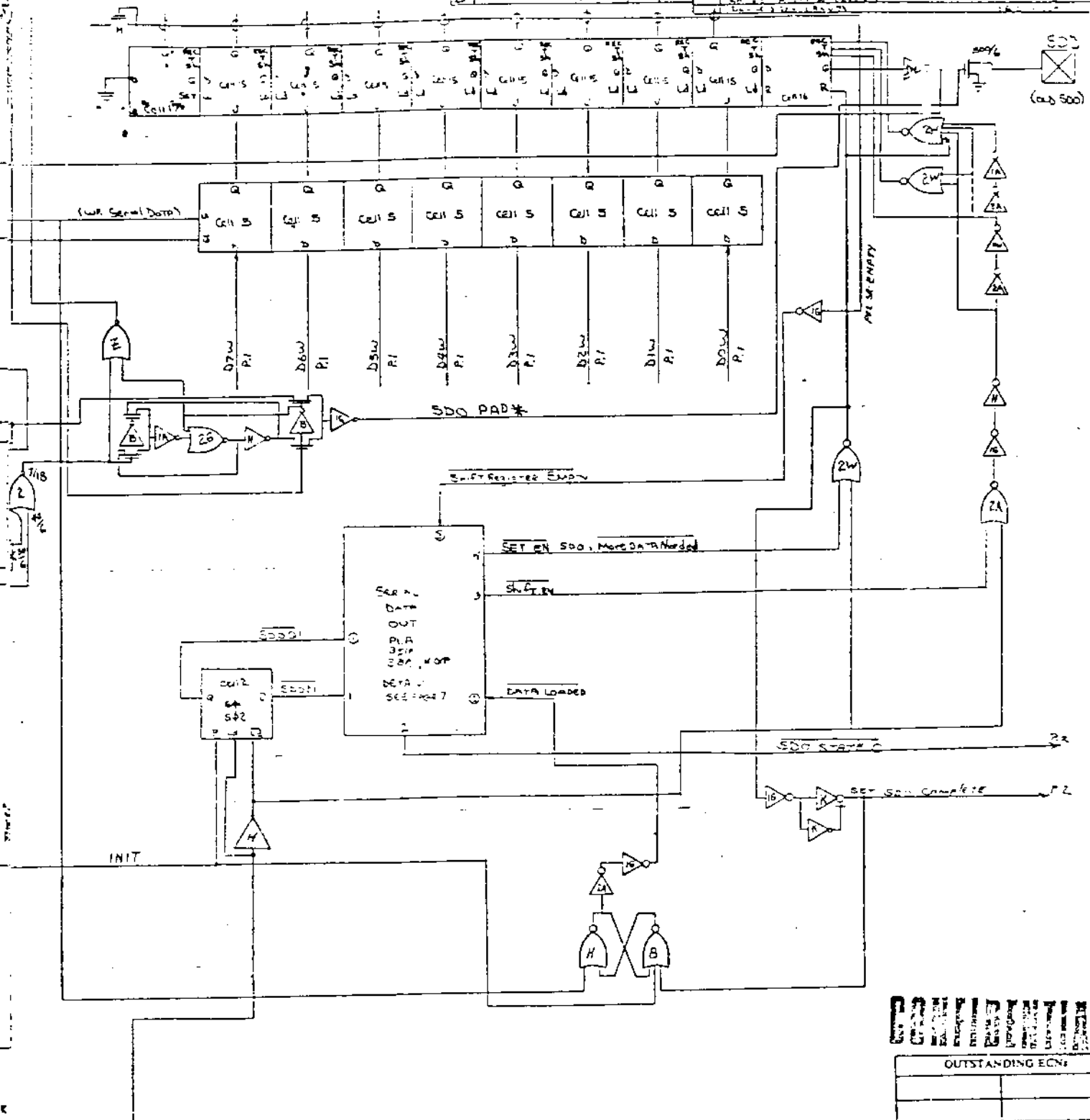

CONFIDENTIAL

OUTSTANDING ECNs	

2600 63 7-10 10/23/81 10/23/81	2600 36 8-23-81	UNLESS OTHERWISE SPECIFIED DIMENSIONS ARE IN INCHES TOLERANCES ON ANGLES ±0.1° SURFACE FINISH ✓ SEE FIG. 1	DO NOT SCALE DRAWING DRAWN BY [Signature] DATE [Date] CHECKED [Signature] PROJECT ENGINEER [Signature] PROJECT ENGINEER [Signature]	ATARI INC. 1265 Borregas Avenue Sunnyvale, CA 94089 ATARI COMMUNICATION SYSTEMS
NOTICE TO ALL PERSONS RECEIVING THIS DRAWING: THIS DRAWING IS THE PROPERTY OF ATARI INC. AND IS TO BE USED ONLY FOR THE PROJECT AND PURPOSE SPECIFIED HEREON. IT IS TO BE KEPT IN A SAFE PLACE AND NOT TO BE LOANED, REPRODUCED, COPIED, OR IN ANY MANNER DISCLOSED TO ANY OTHER PERSON WITHOUT THE WRITTEN PERMISSION OF ATARI INC. IT IS TO BE DESTROYED WHEN NO LONGER NEEDED FOR THE PROJECT AND PURPOSE SPECIFIED HEREON.			TITLE 2600 PAD* 2600 36	DRAFTING NO. CO12294 10ms E SHEET 39 OF 47

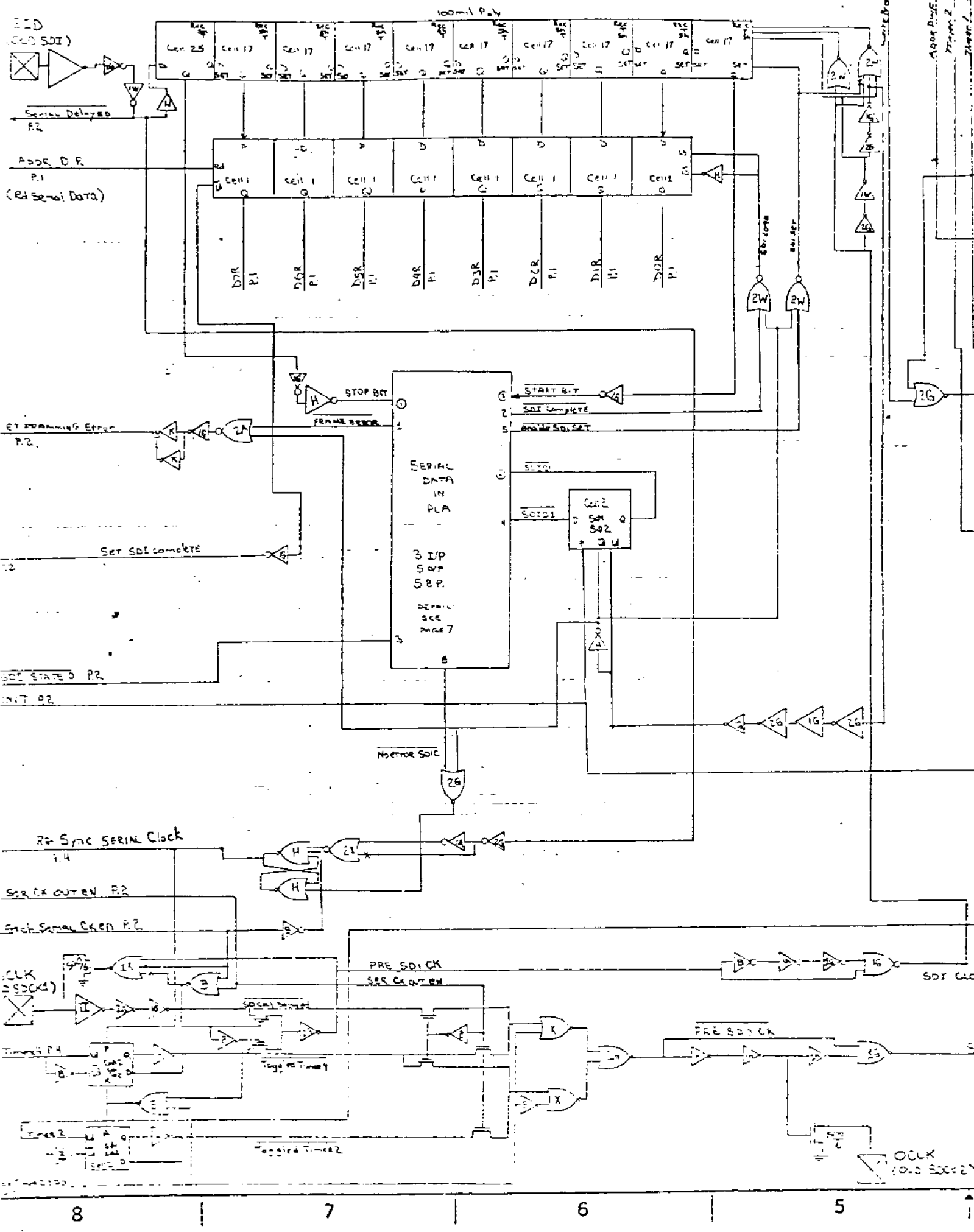

100mV P4V
 10.0 SDCS2

SD1
 (Old SD1)
 Serial Delayed P2
 Addr. D.R. P1
 (Old Serial Data)

ET FORMING Error P2
 Set SD1 complete
 SD1 STATED P2
 INIT P2

SERIAL DATA IN PLA
 3 bit
 SIP
 SVP
 SEP
 SERIAL
 SEE
 PAGE 7

R2 Sync SERIAL Clock
 Ser CK OUT EN P2
 Ench SERIAL CKEN P2

CLK (SD1S2)
 10.0 SDCS2

8 7 6 5

Cell 26,21 (REV B)	7-1-78	DA
Cell 2,7,22 (REV A)	8-9-78	DA
Cell 3,4,1 (REV A)	8-25-78	DA
B SEE SHEET 1		

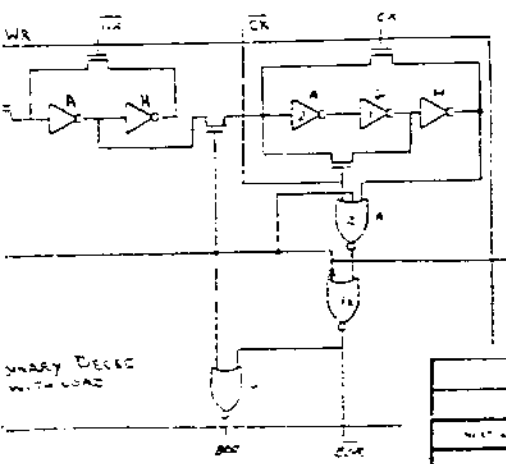
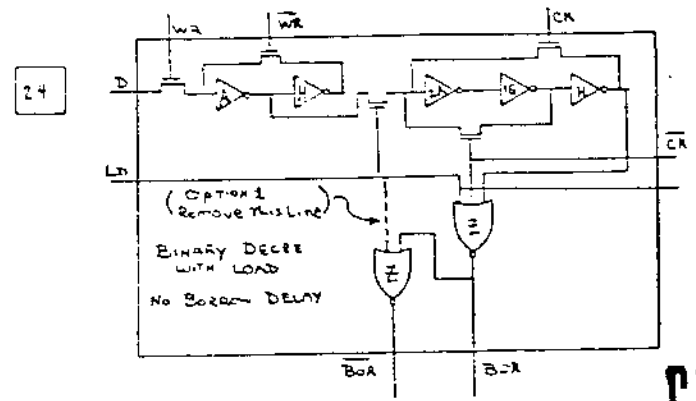
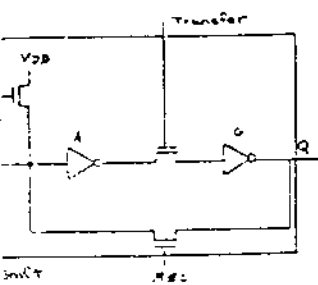
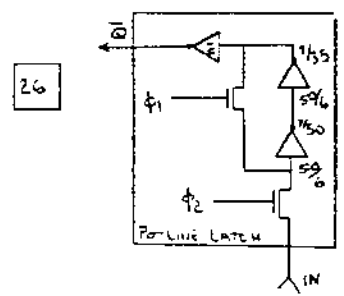
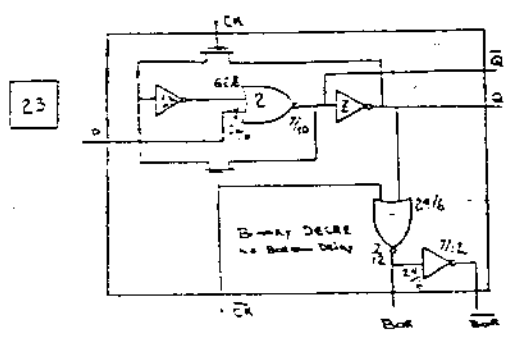
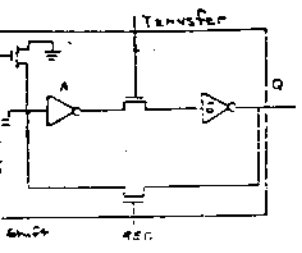
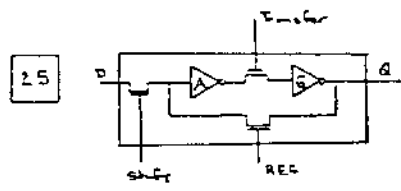
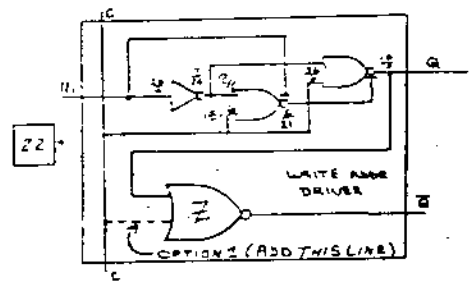
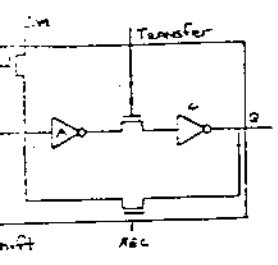
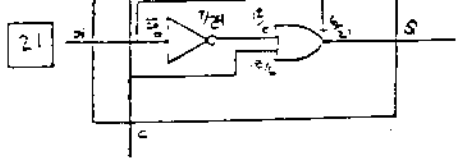
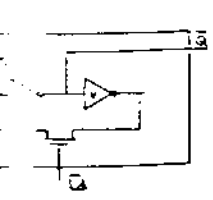

CONTROL
 Atari Inc.
 1265 Bayview Avenue
 Sunnyvale, CA 95085

OUTSTANDING ECNs	

UNLESS OTHERWISE SPECIFIED DIMENSIONS ARE IN INCHES TOLERANCES ON ANGLES - 1/4° FINISH - 125 REFERENCE FINISH - 125 & 100	DO NOT SCALE DRAWING	Atari Inc. 1265 Bayview Avenue Sunnyvale, CA 95085
	DRAWN BY: _____ DATE: _____ CHECKED: _____ DESIGNED: _____ APPROVED: _____ WFO ENGINEER: _____	
MATERIAL: _____ PRICE: _____	Dwg. No. <u>CO12294</u> Scale: _____	Rev. _____

NOTICE TO ALL PERSONS RECEIVING THIS DRAWING:
 THIS DRAWING IS THE PROPERTY OF ATARI INC. AND IS LOANED TO YOU FOR YOUR INFORMATION ONLY. IT IS NOT TO BE REPRODUCED, COPIED, OR DISTRIBUTED IN ANY MANNER WITHOUT THE WRITTEN PERMISSION OF ATARI INC. ANY UNAUTHORIZED REPRODUCTION OR DISTRIBUTION OF THIS DRAWING IS STRICTLY PROHIBITED AND WILL BE PROSECUTED TO THE FULL EXTENT OF THE LAW.

CO12294
 40
 B

C

B

A

4

3

2

1

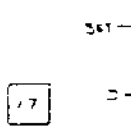
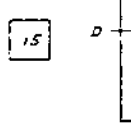
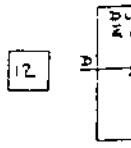
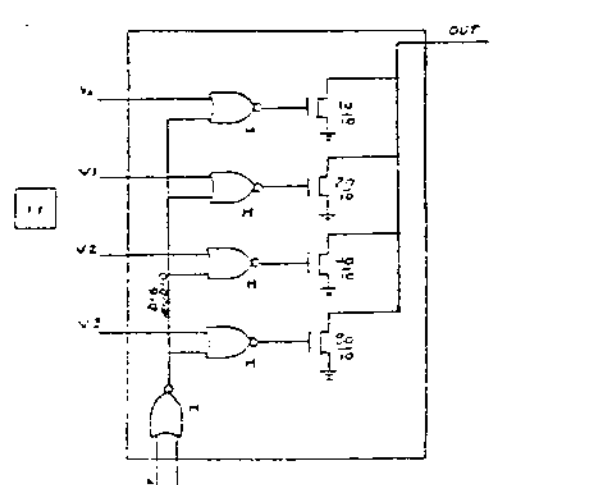
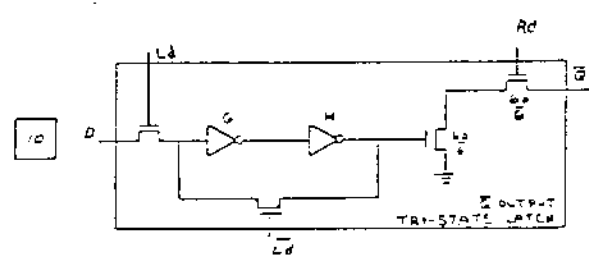
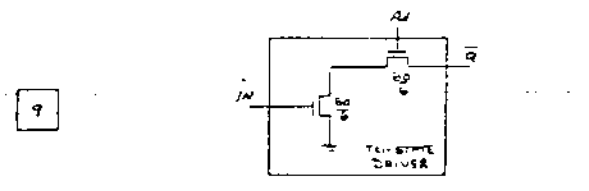
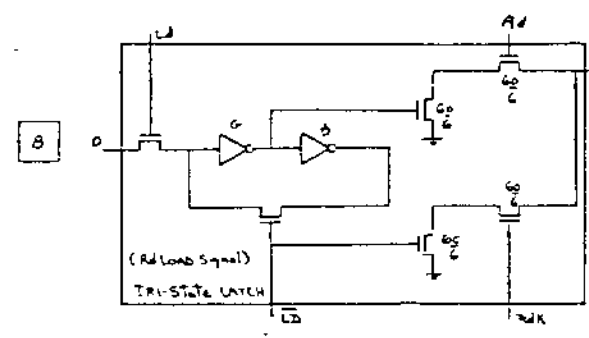
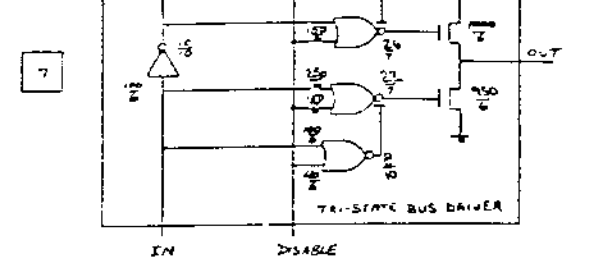
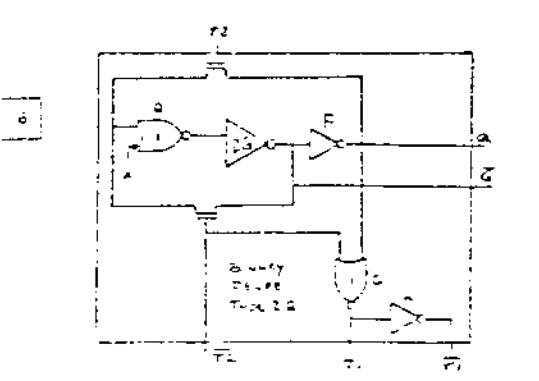
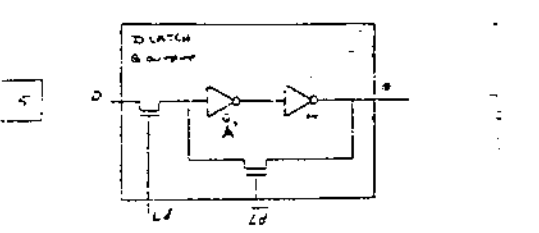
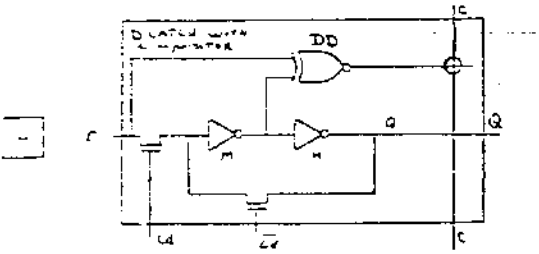
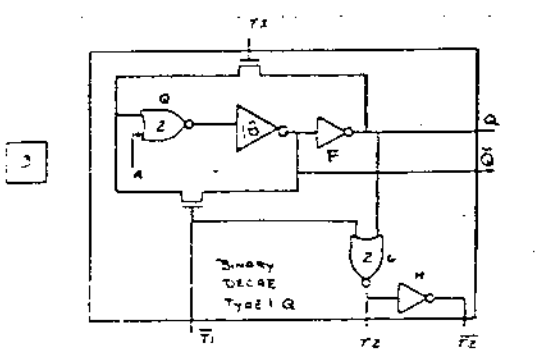
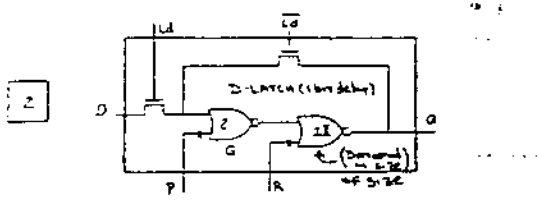
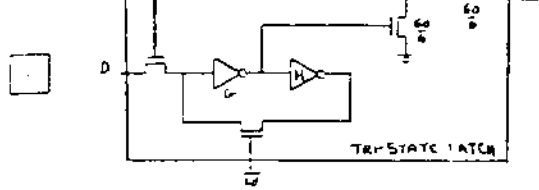

8

7

6

5

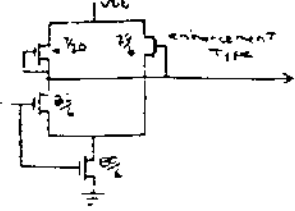

Keyboard CONTROL PLA, PAGE 2

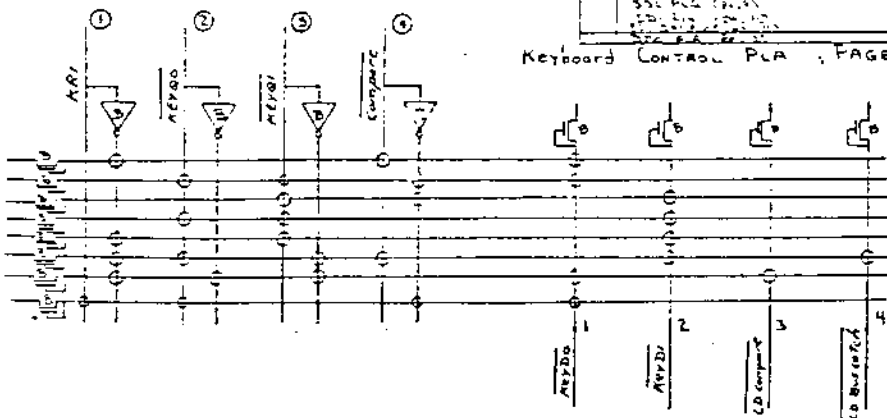

SERIAL DATA IN PLA, PAGE 5

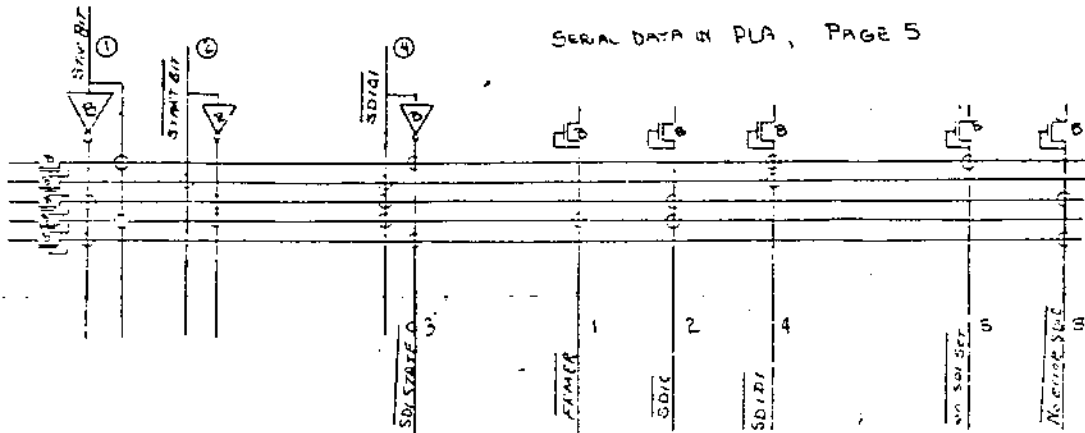

SERIAL DATA OUT PLA, PAGE 5

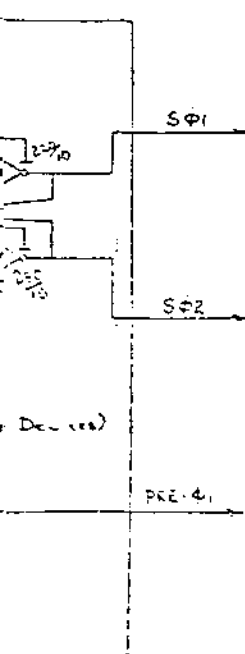
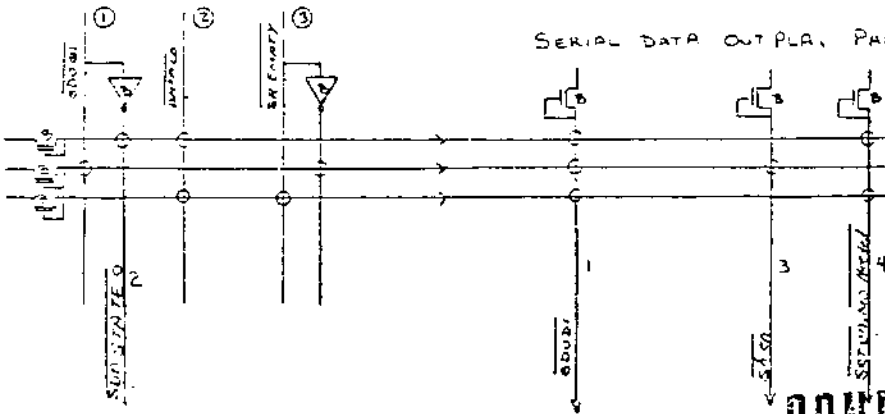

CONFIDENTIAL

OUTSTANDING ECNs

<p>UNLESS OTHERWISE SPECIFIED DIMENSIONS ARE IN INCHES TOLERANCES ON:</p> <p>ANGLES ± 1/2°</p> <p>SURFACE FINISH: 125 ± 0.001</p>		<p>DO NOT SCALE DRAWING</p> <p>DRAWN BY: _____ DATE: _____</p> <p>CHECKED: _____</p> <p>PROJECT: EST 484</p> <p>DATE MONITOR: _____</p>		<p>ATARI INC.</p> <p>1255 Romegas Avenue</p> <p>Sunnyvale, Calif. 94088</p> <p>Member Atari Inc. Atari Corporation</p>	
<p>MATERIAL:</p> <p>FINISH:</p>		<p>TITLE: <u>POWER CO12294</u></p> <p>Part Details, Emu 8100</p> <p>PAGE 7</p>		<p>FILE: <u>CO12294</u></p> <p>DRAWING NO: <u>CO12294</u></p> <p>SHEET: <u>8</u> OF <u>8</u></p>	

NOTE TO ALL: THIS DRAWING IS THE PROPERTY OF ATARI INC. AND IS NOT TO BE REPRODUCED OR TRANSMITTED IN ANY FORM OR BY ANY MEANS, ELECTRONIC OR MECHANICAL, INCLUDING PHOTOCOPYING, RECORDING, OR BY ANY INFORMATION STORAGE AND RETRIEVAL SYSTEM. ALL RIGHTS ARE RESERVED.

DRAWING NO: CO12294
SHEET: 41 OF 8

C

B

A

4

3

2

1

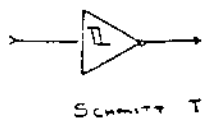
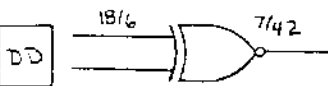
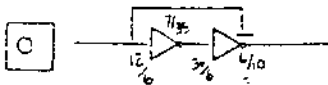
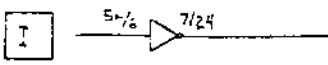
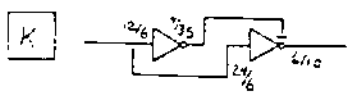
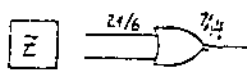
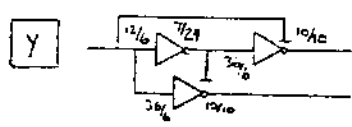
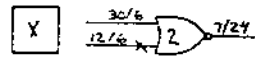
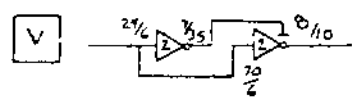
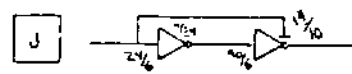
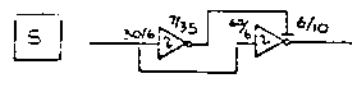
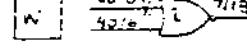
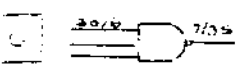
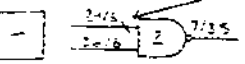
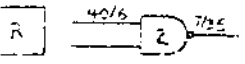
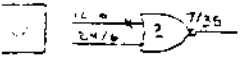
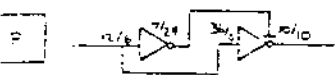
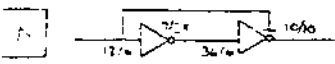
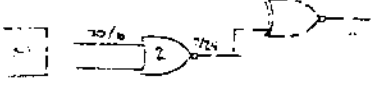
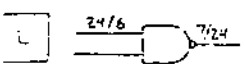
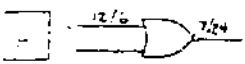
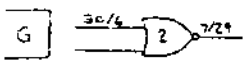
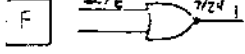
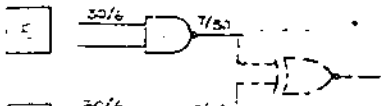
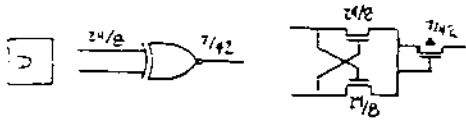
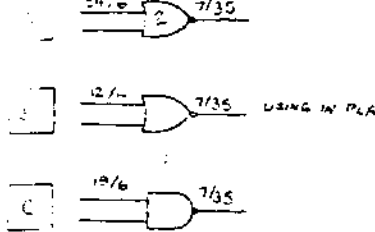

INDICATES NO COUPLER ON THIS INPUT.

NOTE:

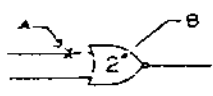

A X INDICATES NO COUPLER ON THAT INPUT.
B NUMBER INDICATES CLOCK PHASE OF INPUT COUPLERS.

