

**Trinitron® Color TV**

---

**KV-20TS27      KV-20TR22****KV-2137RS      KV-2127R****Operating Instructions**

Before operating the unit, please read this manual thoroughly and retain it for future reference.

**Owner's Record**

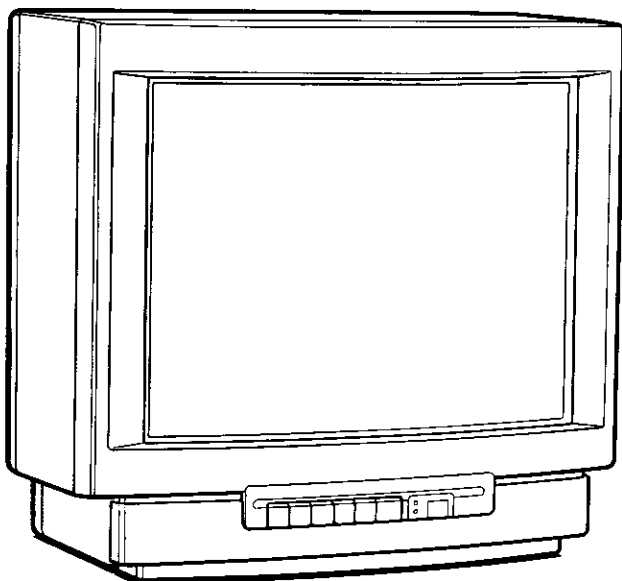

The model and serial numbers are located at the rear of the unit. Record these numbers in the spaces provided below. Refer to them whenever you call upon your Sony dealer regarding this product.

Model No. \_\_\_\_\_ Serial No. \_\_\_\_\_



# WARNING

To prevent fire or shock hazard, do not expose the unit to rain or moisture.

	<b>CAUTION</b> RISK OF ELECTRIC SHOCK DO NOT OPEN	
<p>CAUTION : TO REDUCE THE RISK OF ELECTRIC SHOCK, DO NOT REMOVE COVER (OR BACK). NO USER-SERVICEABLE PARTS INSIDE. REFER SERVICING TO QUALIFIED SERVICE PERSONNEL.</p>		

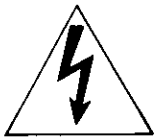

This symbol is intended to alert the user to the presence of uninsulated "dangerous voltage" within the product's enclosure that may be of sufficient magnitude to constitute a risk of electric shock to persons.



This symbol is intended to alert the user to the presence of important operating and maintenance (servicing) instructions in the literature accompanying the appliance.

---

**CAUTION:**

TO PREVENT ELECTRIC SHOCK, DO NOT USE THIS POLARIZED AC PLUG WITH AN EXTENSION CORD, RECEPTACLE OR OTHER OUTLET UNLESS THE BLADES CAN BE FULLY INSERTED TO PREVENT BLADE EXPOSURE.

---

---

**Note to CATV system installer**

This reminder is provided to call the CATV system installer's attention to Article 820-22 of the NEC that provides guidelines for proper grounding and, in particular, specifies that the cable ground shall be connected to the grounding system of the building, as close to the point of cable entry as practical.

---

# Identifying Your TV

Instructions in this manual are based on the model with maximum functions (KV-20TS27). Please disregard information that does not apply to your TV.

## Check the model number of your TV set.

This manual covers several models and there are slight differences among them. Check the table below to see what is equipped with your TV before you begin operating it.

Table for each model      YES: equipped      NO: not equipped

Models	KV-20TS27	KV-20TR22	KV-2137RS	KV-2127R
<b>Major features</b>				
<b>Stereo reception</b>	YES	NO	YES	NO
<b>MTS decoder</b>	YES	NO	YES	NO
<b>VIDEO INPUT jacks</b>	3 phono jacks	2 phono jacks	3 phono jacks	2 phono jacks
<b>AUDIO OUTPUT jacks</b>	YES (VARIABLE)	NO	YES (VARIABLE)	NO
<b>SPEAKER switch on the rear panel</b>	YES	NO	YES	NO
<b>Supplied Remote Commander</b>	RM-783	RM-781	RM-783	RM-781
<b>Telescopic dipole antenna</b>	YES*	YES	YES	YES
<b>Model destination</b>	U.S.A./CANADA	U.S.A.	Central and South America and other areas	Central and South America and other areas

\* Supplied only with U.S.A. models.

# Contents

## **BEFORE USE**

Features .....	5
Precautions .....	5
Location of Controls .....	6

## **SET-UP**

Connecting TV Antenna/Cable .....	9
-----------------------------------	---

## **OPERATION**

Watching TV Programs .....	12
Adjusting the Picture .....	13

## **USEFUL FUNCTIONS**

Presetting TV Channels .....	14
Using the TIMER/BLOCK Functions .....	16
Available Functions .....	16
Setting the Internal Clock .....	17
Setting Channel BLOCK .....	18
Setting the Program Start TIMER .....	19
Other Useful Features .....	20

## **CONNECTIONS**

Connecting Optional Equipment .....	21
-------------------------------------	----

## **GENERAL**

Specifications .....	23
Troubleshooting .....	23

# Features

**Color monitor featuring a Microblack™ Trinitron picture tube for high resolution, high contrast picture.**

- **Multi-band VHF/UHF/CATV tuner** receives up to 125 cable channels for a total of 181 possible off-air and cable channels.
- **Built-in MTS (Multichannel TV Sound) decoder** provides reception of stereo programs and Second Audio Program (SAP) broadcasts. (KV-20TS27, KV-2137RS only) (p. 20)
- **Built-in video input jacks** provide a better quality picture with VCR or other connected equipment.
- **Variable audio output jacks** let you reproduce TV or video sound through an audio system. (KV-20TS27, KV-2137RS only)
- **On-screen displays**

**Supplied Remote Commander** provides you with many other convenient features.

- **TIMER/BLOCK** for automatic program starting and channel blocking. (pp. 16-19)
- **SLEEP timer** automatically turns off the TV after approximately one hour. (p. 20)
- **AUTO PGM (Automatic programming)** presets all receivable channels instantly. (pp. 14, 15)
- **JUMP button** switches quickly between two channels (p. 20)

And other features for a high quality picture..

- **Dynamic color™ system** for superior color reproduction with natural facial color tones and dazzling whites.
- **Dynamic picture™ system** adjusts picture contrast automatically, to produce more detail in both bright and dark areas of every scene.

# Precautions

## Safety

- Operate the TV only on 120 V AC.
- One blade of the plug is wider than the other for safety purposes and will fit into the power outlet only one way. If you are unable to insert the plug fully into the outlet, contact your dealer.
- Should any liquid or solid object fall into the cabinet unplug the TV and have it checked by qualified personnel before operating it any further.
- Unplug the TV from the wall outlet if you are not going to use it for several days or more. To disconnect the cord, pull it out by the plug. Never pull the cord itself.

## Installation

- To prevent internal heat build-up, do not block the ventilation openings.
- Do not install the unit in a hot or humid place, or in a place subject to excessive dust or mechanical vibration.

## Cleaning

Clean the TV with a slightly damp soft cloth. Use a mild household detergent. Never use strong solvents such as thinner or benzine, as they might damage the finish of the cabinet.

## Repacking

Retain the original carton and packing materials for safe transport of your TV in the future.

---

Use of this television receiver for other than private viewing of programs broadcast on UHF or VHF, or transmitted by cable companies for the use of the general public may require authorization from the broadcaster/cable company and/or program owner.

---

If you have any questions or problems concerning your TV, please contact your nearest Sony dealer.

For details concerning safety precautions, see the leaflet "IMPORTANT SAFEGUARDS."

# Location of Controls

Refer to the pages indicated in ● for details.

Front

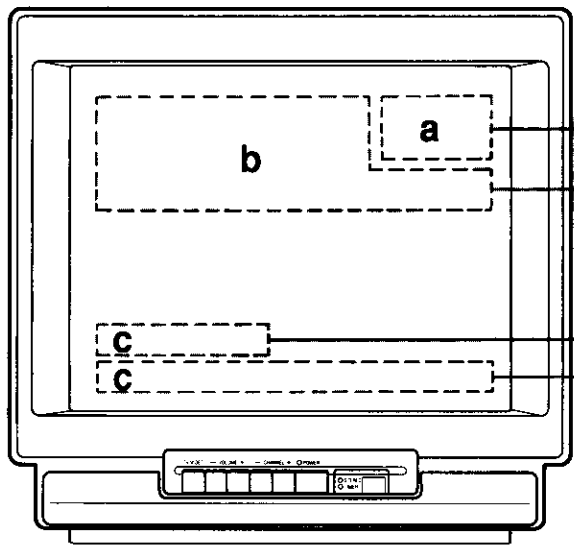

## On-Screen Displays

- a**
- Channel numbers/Cable "C" display
  - MTS mode indication (KV-20TS27, KV-2137RS only)
  - "MUTING," "SLEEP" or "VIDEO" display

- b**
- "AUTO PROGRAM," "TIMER" or "TIMER BLOCK" display

- c**
- Bar display for volume or picture (HUE, COLOR, BRIGHTNESS, SHARPNESS) adjustment
  - Current time for TIMER/BLOCK

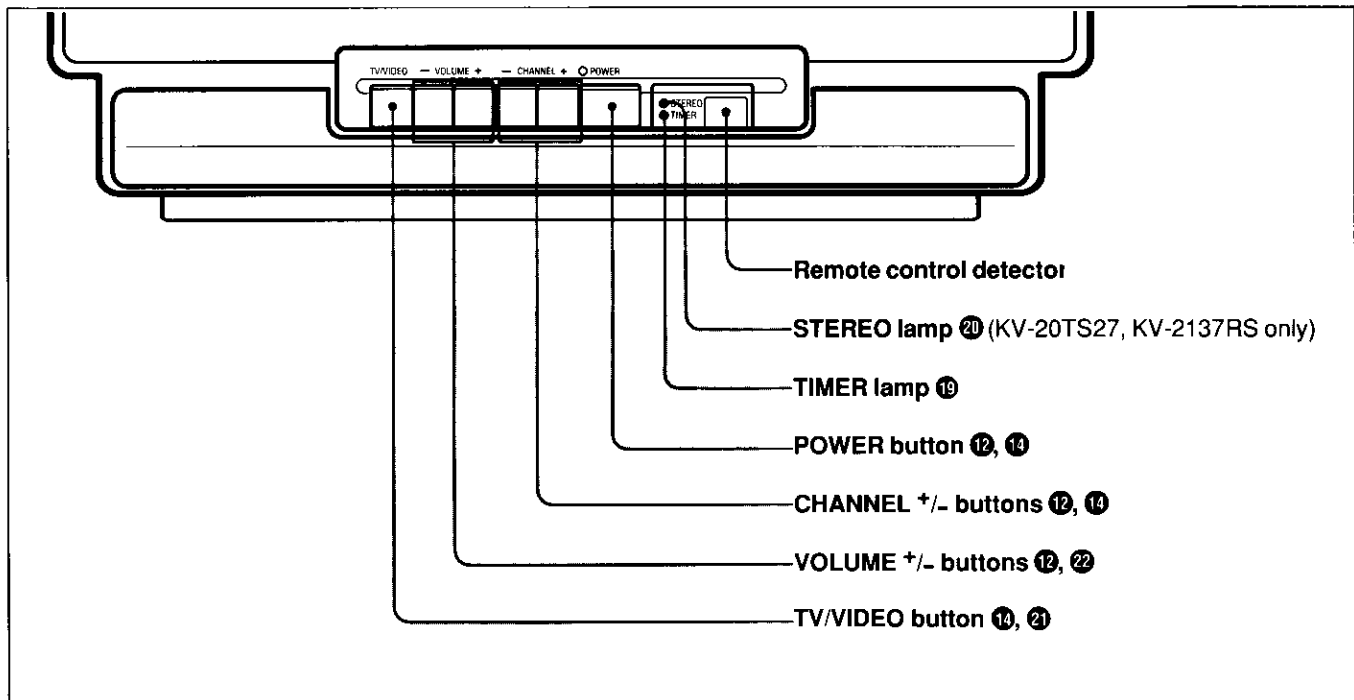

**Rear**

KV-20TR22  
KV-2127R

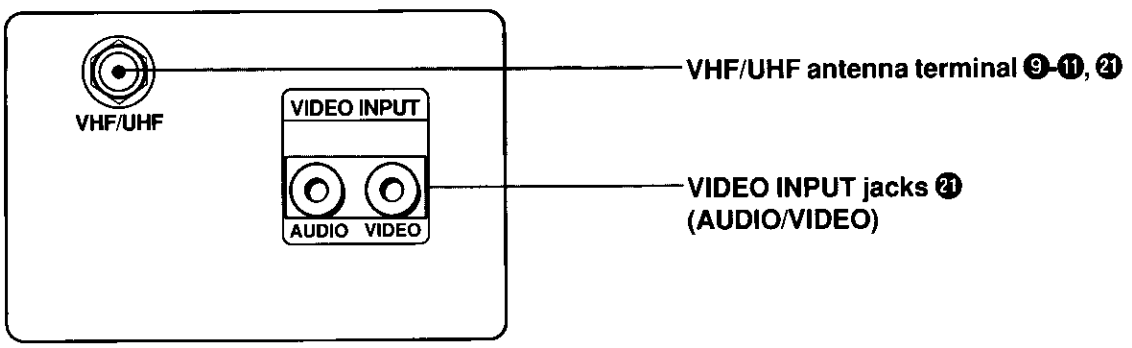

KV-20TS27  
KV-2137RS

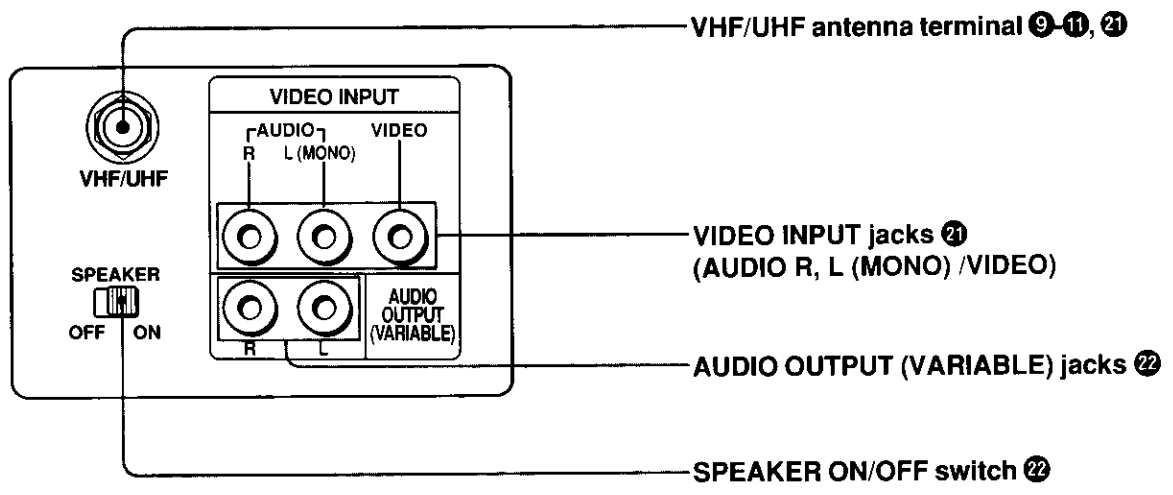

# Location of Controls (cont'd. from p. 7)

## Remote Commander RM-781/RM-783

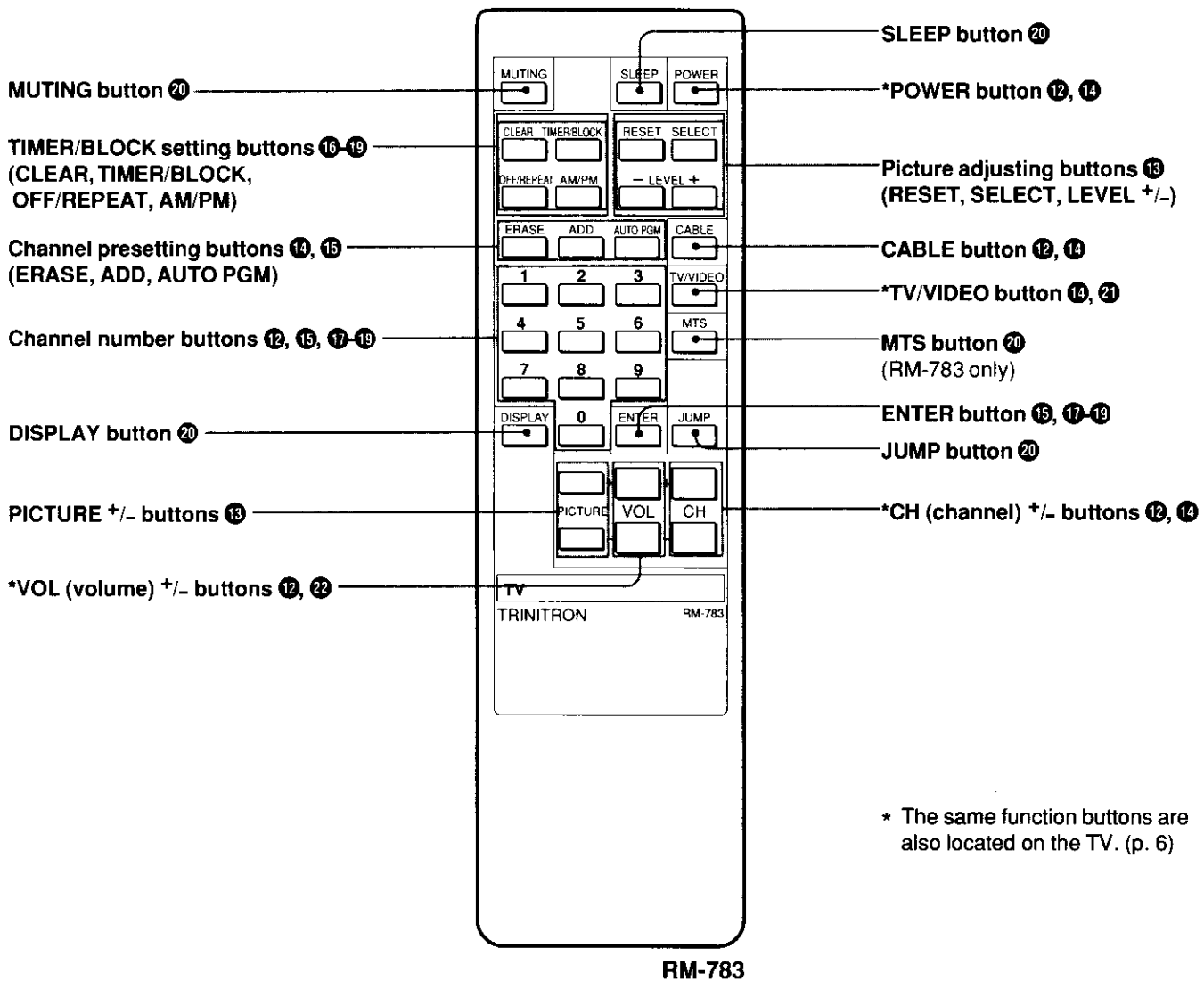

\* The same function buttons are also located on the TV. (p. 6)

### Battery installation

**1** Open the lid.

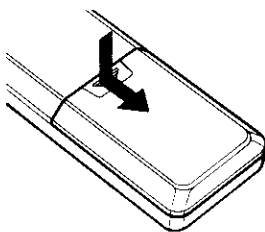

**2** Insert two size AA (R6) batteries in correct polarity.

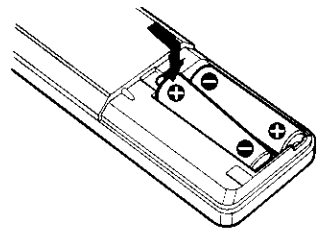

- With normal operation, batteries will last up to half a year. If the Commander does not operate properly, the batteries might be exhausted. Replace them with new ones.
- To avoid damage from possible battery leakage, remove the batteries when not using the Commander for an extended period.
- If a Remote Commander that is not recommended is used to operate this TV, or if the supplied Remote Commander is used to operate another TV, the TV may not operate properly.



# Connecting TV Antenna/Cable →

## Indoor Antenna Adjustment

For VHF/UHF reception

Use the supplied telescopic dipole antenna.

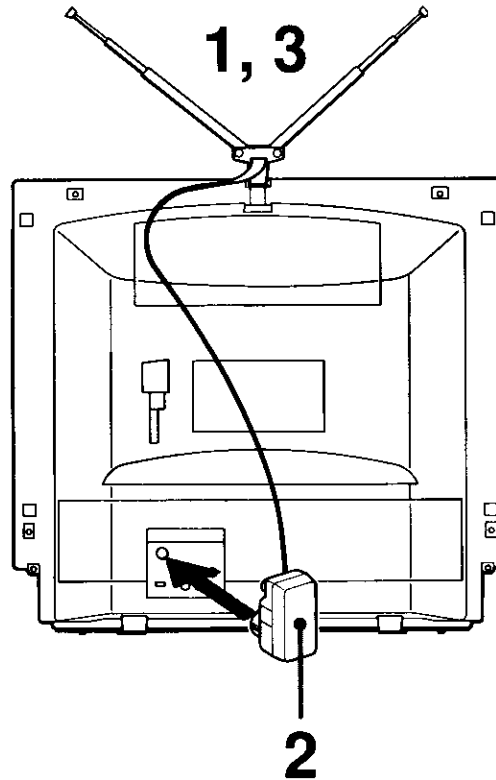

**1** Insert the antenna base into the receptacle at the top of the TV.

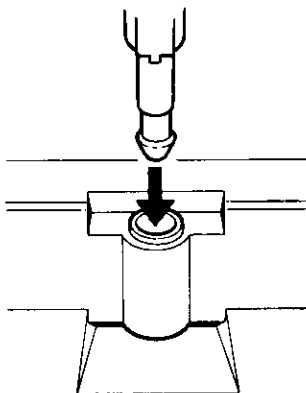

**2** Attach the connector to the VHF/UHF antenna terminal at the rear of the TV.

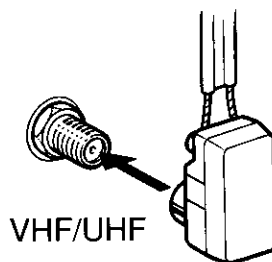

**3** Adjust the length, direction and angle of the antenna ears until the picture is clear.

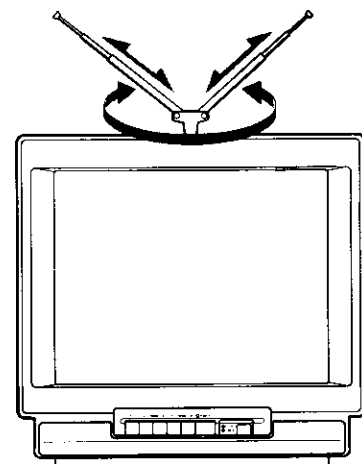

# Connecting TV Antenna/Cable (cont'd. from p. 9)

## Outdoor Antenna Connection

If you cannot obtain satisfactory reception with an indoor antenna, use an outdoor antenna. Cable TV reception is only obtained by connecting a cable supplied by your local cable operator.

To connect a VHF, UHF, or VHF/UHF combination antenna\* or CATV cable

**1** Check the cable type and prepare the cable end using the appropriate connector.

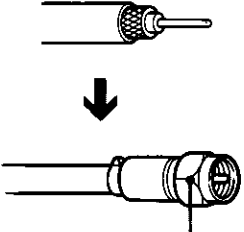
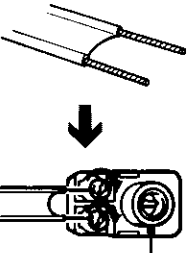
a. 75-ohm coaxial cable (round)	b. 300-ohm twin-lead cable (flat)
 <p>Attach an optional F-type connector.**</p>	 <p>Fasten with a screwdriver.</p> <p>Antenna connector</p>

**2** Attach the connector to the VHF/UHF terminal at the rear of the TV.

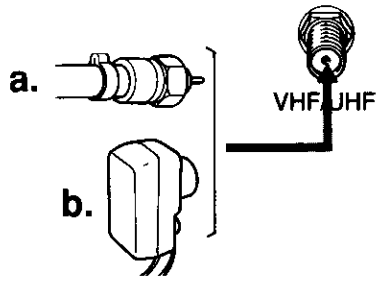

\* Most combination antennas are equipped with a signal splitter. Remove the splitter and attach the appropriate connector.

\*\* How to attach an F-type connector to the 75-ohm coaxial cable

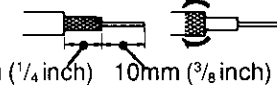
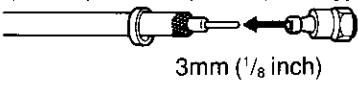
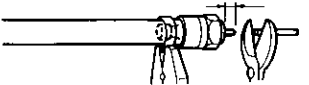
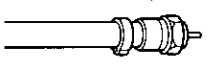
- 1 
- 2 
- 3 
- 4 

**When you connect both VHF and UHF antennas**  
Use the optional EAC-66 U/V mixer.

When the U/V mixer is used  
Snow and noise may appear in the pictures of the  
cable TV channels over 37 (W+1).

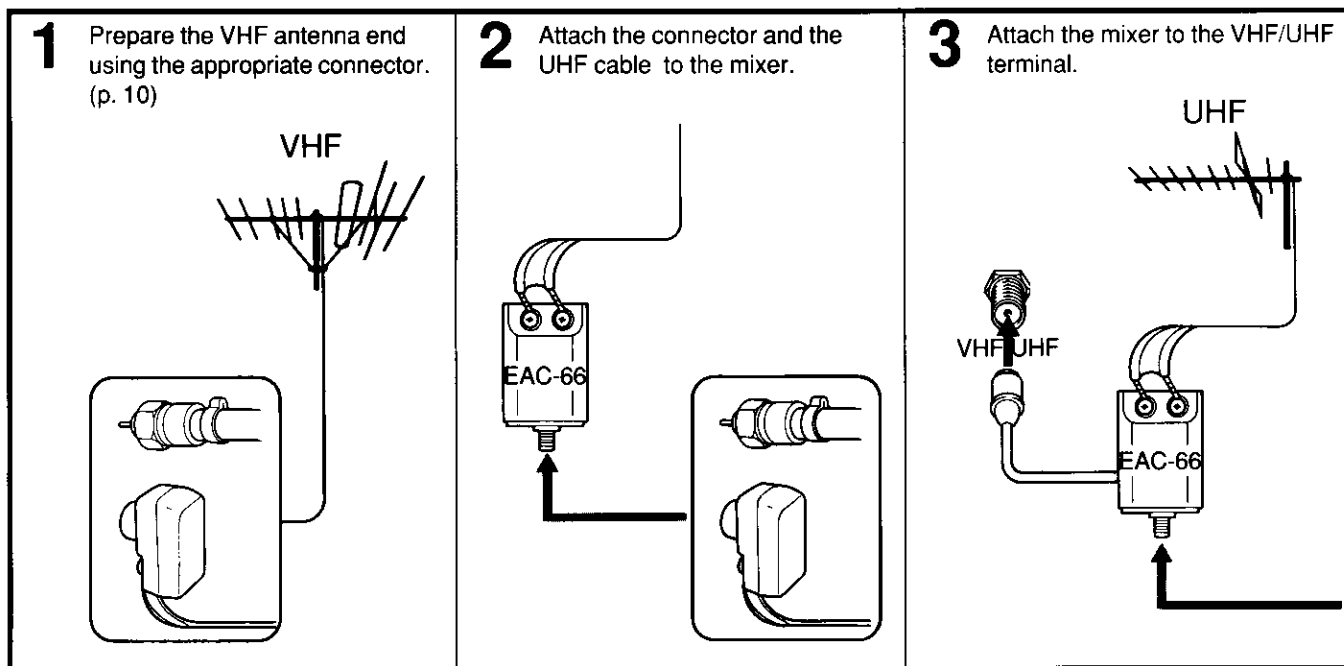
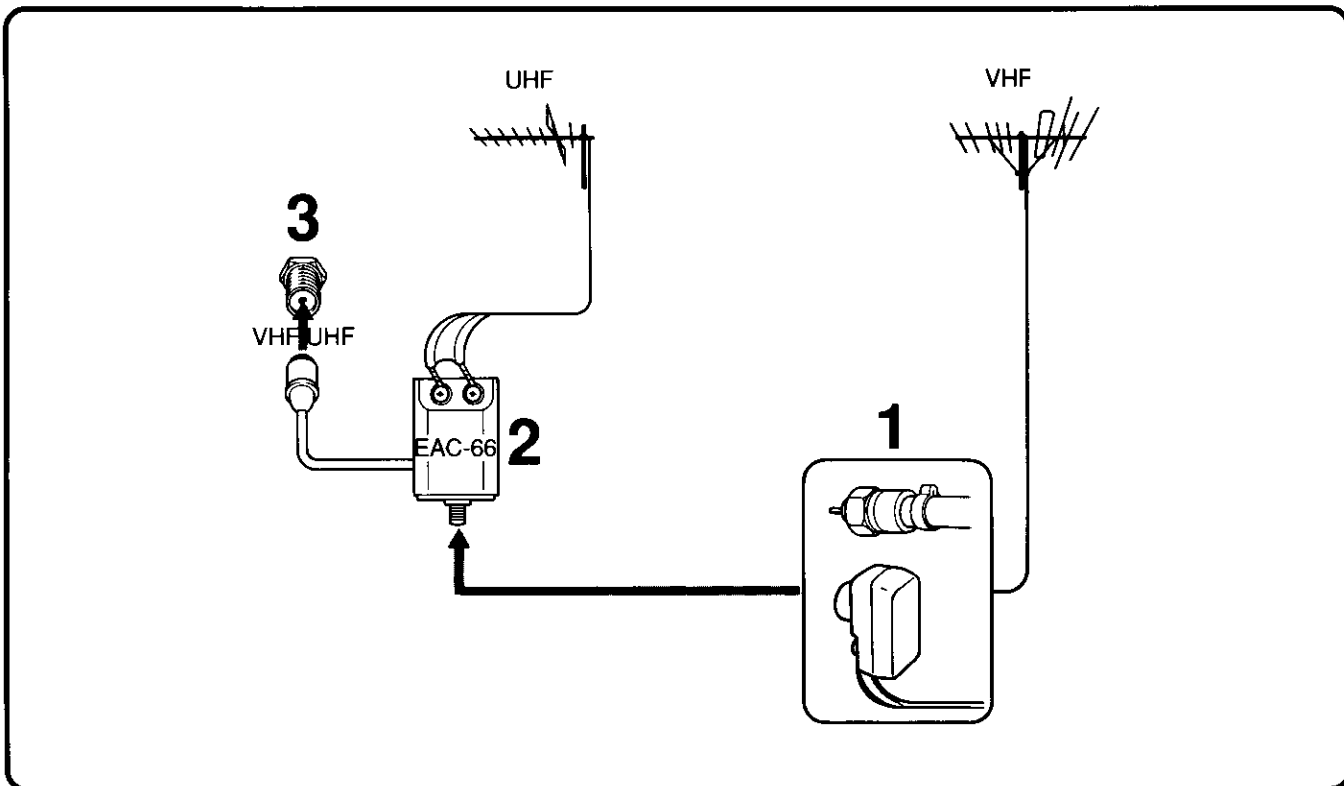



# Adjusting the Picture

Press SELECT repeatedly until the on-screen display of the feature you want to adjust appears, then press LEVEL +/- to adjust the feature.

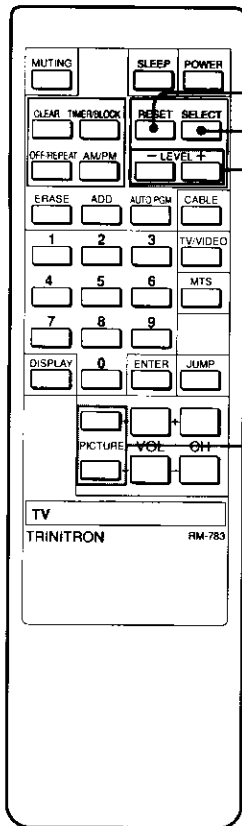

RESET  
SELECT  
LEVEL +/-

PICTURE +/-

RM-783

**HUE**

- LEVEL +

Press LEVEL - .  
Skin tones become purplish.

Press LEVEL + .  
Skin tones become greenish.

---

**COLOR**

- LEVEL +

Press LEVEL - to decrease color intensity.

Press LEVEL + to increase color intensity.

---

**BRIGHT (brightness)**

- LEVEL +

Press LEVEL - to make the picture darker.

Press LEVEL + to make the picture lighter.

---

**SHARPNESS**

- LEVEL +

Press LEVEL - to make the picture softer.

Press LEVEL + to make the picture sharper.

After you finish adjusting a feature, the display will disappear after a few seconds.

The adjustments you make will remain set even when you turn the TV off. To clear the adjustment levels and restore all the factory (mid-level) settings at once, press RESET.

**To adjust picture contrast**

PICTURE +

Press PICTURE - to decrease contrast with soft color.

Press PICTURE + to increase contrast with vivid color.

# Presetting TV Channels

Use this feature to add channels to the channel scan memory.

## To Preset All Receivable Channels Automatically

KV-20TS27

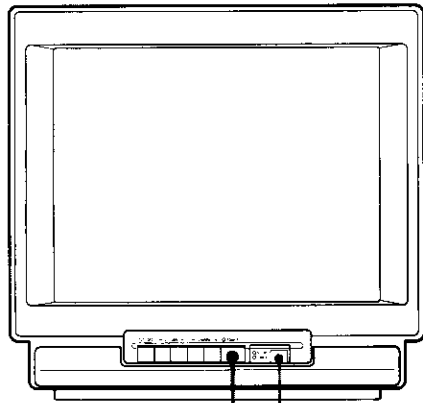

**1** Remote control detector

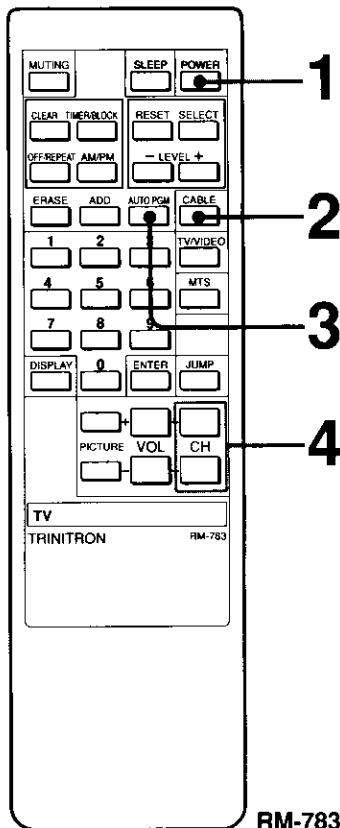

RM-783

**1** Press **POWER** on the TV or the Remote Commander to turn the TV on.



**2** Press **CABLE** so that the appropriate mode appears.

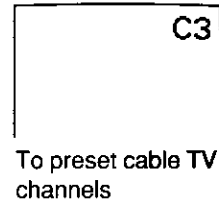
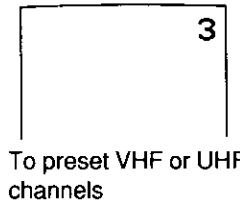
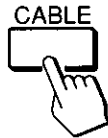

**NOTE**

If "VIDEO" is displayed on the screen Press the TV/VIDEO button on the TV or on the Remote Commander so that a channel number appears.

**3** Press **AUTO PGM.**



"AUTO PROGRAM" is displayed on the screen and receivable channels (other than the channels already preset) will be preset in numerical sequence. The channels previously preset remain in the TV's memory.

When no more channels can be found, the programming stops and the lowest numbered channel is displayed.

**4** To check or view preset channels Press **CH +/-**

**Channels that can be received on this TV:**

- VHF: 2 - 13
- UHF: 14 - 69
- Cable: 1 - 125

To add channels that could not be preset automatically because their signal strength was too weak, or to erase unnecessary channels, follow the steps in "To preset only the desired channels" on the next page.

## To Preset Only Desired Channels or to Erase Unnecessary Channels

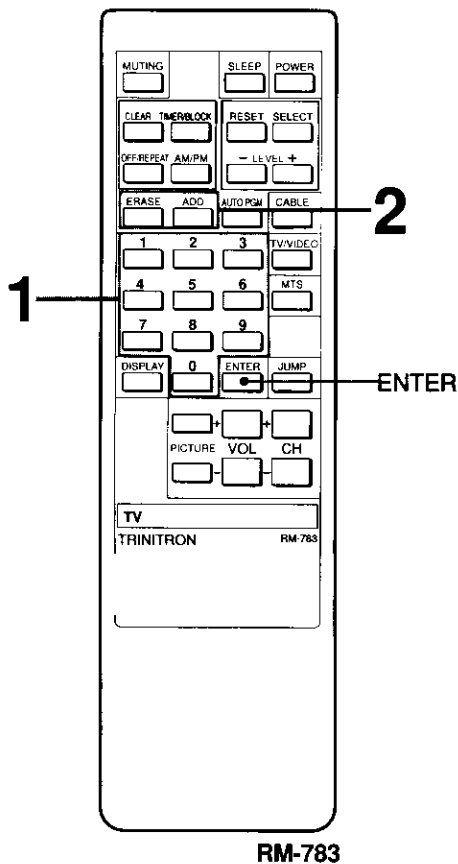

**1** Press the channel number button(s) and then press ENTER to select the channel you want to add or erase.

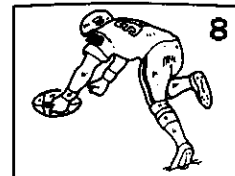
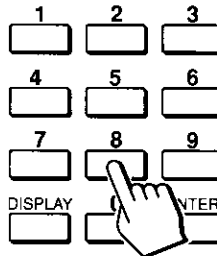

**2** To add channels - Press ADD.



A "+" appears before the number for a moment.  
This channel has now been added to the channel scan memory.

To erase channels - Press ERASE.



A "-" appears before the number for a moment.  
This channel has now been erased from the channel scan memory.  
The next time the CH +/- button is pressed, this channel will be skipped.

Repeat steps 1 and 2 to add or erase other channels.

### CAUTION

#### When a VHF or UHF channel is erased

The cable TV channel with the same number is also erased, and vice versa.

### Cable TV channel chart\*

Cable TV systems use letters or numbers to designate channels. To tune in a channel, refer to the chart below.

Number on this TV	1	5	6	14	15	16	17	18	19	20	21	22	23	24	25	26	27	28	29	30		
Corresponding CATV channel	A-8	A-7	A-6	A	B	C	D	E	F	G	H	I	J	K	L	M	N	O	P	Q		
	31	32	33	34	35	36	37	38	39	93	94	95	96	97	98	99	100	101	102	123	124	125
	R	S	T	U	V	W	W+1	W+2	W+3	W+57	W+58	A-5	A-4	A-3	A-2	A-1	W+59	W+60	W+61	W+82	W+83	W+84

Check with your local cable TV company for more complete information on the available channels.

\* This designation of cable TV channels conforms to the EIA/NCTA recommendation.

### Note

Pay cable TV systems use scrambled or encoded signals and require special converters (decoders) in addition to the normal cable connection.

# Using the TIMER/BLOCK Functions

## Available Functions

<b>Internal clock</b>	Once the internal clock is set, the current time will be displayed on the screen. You must set the clock correctly to activate the program start TIMER and channel BLOCK.
<b>Program start TIMER</b>	Makes a program of your choice appear on the screen automatically at the desired time.
<b>Channel BLOCK</b>	Blocks a channel from appearing on the screen for 12 hours. Use channel BLOCK to prevent children from watching undesirable programs.

The buttons used for the above functions are located on the Remote Commander.

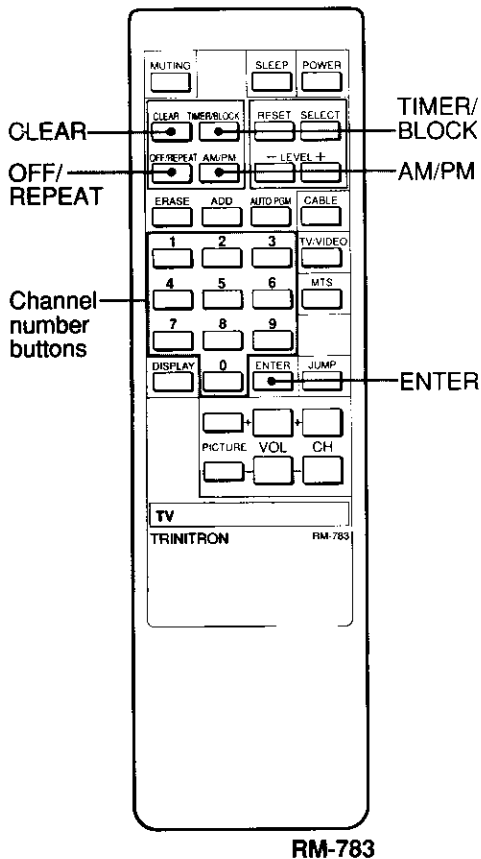

To set the internal clock, program start TIMER and channel BLOCK, you need to go into the corresponding "pages": "clock page," "TIMER page" and "BLOCK page."

To change the "pages," press TIMER/BLOCK.

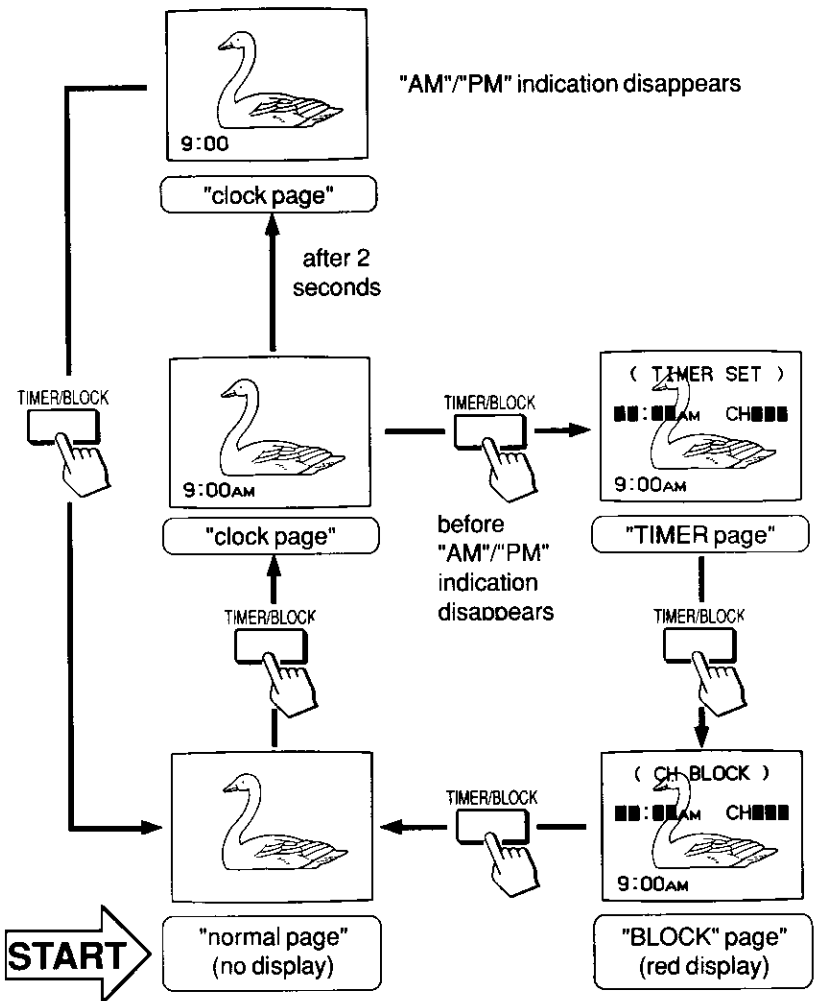

### CAUTION

- All settings will be erased from the TV's memory if the TV is unplugged, or if a power failure occurs.
- The TIMER and BLOCK functions will operate only if the clock is set correctly.
- If the TIMER and BLOCK are set for overlapping times on the same channel, the blocked channel will appear on the screen at the time set on the TIMER.





# Setting the Internal Clock

Example: To set the clock to 8:05 PM

**1** From "normal page" (no display), press TIMER/BLOCK once to change to "clock page."

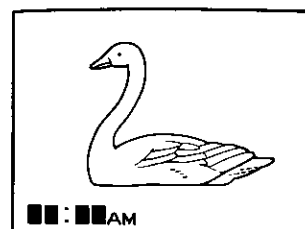
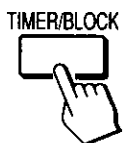

"clock page" (green display)

**2** Press 0, 8, 0, 5, AM/PM. (You must press the 0's)

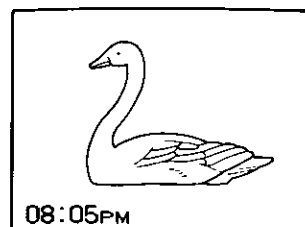
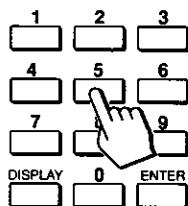

**3** If you have performed the operation correctly, press ENTER. The screen display will blink once, indicating that the clock has been set. (The 0 in front will disappear.)

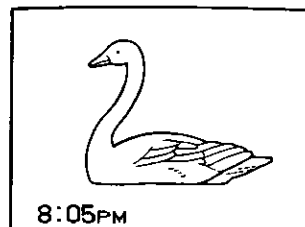

**If you make a mistake, press CLEAR and proceed from step 2.**

The "AM/PM" indication will disappear after a few seconds.

To summon "TIMER page," press TIMER/BLOCK before the "AM"/"PM" indication disappears.

To return to "normal page," press TIMER/BLOCK after the "AM"/"PM" indication has disappeared.

**To reset the clock, summon "clock page" and press CLEAR before the "AM"/"PM" indication disappears. Then follow the steps above from step 2.**

12:00 AM stands for midnight.  
12:00 PM stands for noon.

# Using the TIMER/BLOCK Functions (cont'd. from p. 17)

## Setting Channel BLOCK

Make sure that the clock has been set correctly before setting channel BLOCK. (p. 17)

EXAMPLE: To set a BLOCK for a program which begins at 9:30 AM on channel 8

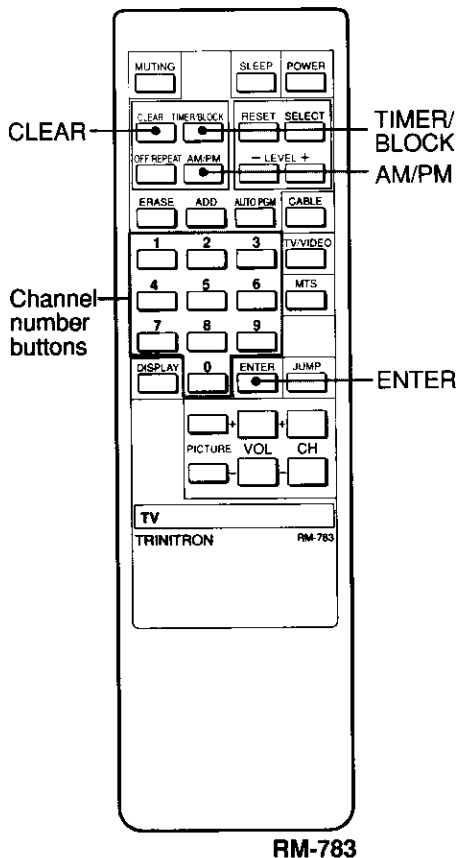

**1** To change from "normal page" to "BLOCK page," press TIMER/BLOCK three times.

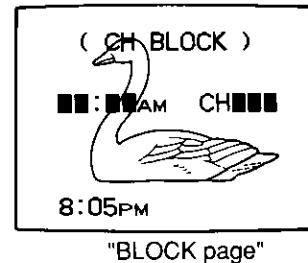
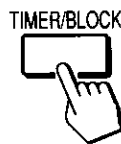

**2** Press 0, 9, 3, 0, ENTER (you must press the 0's). The screen display will blink once, indicating that the time has been set. Press 8, ENTER (0 not necessary). The numbers will blink, indicating that the channel has been set.

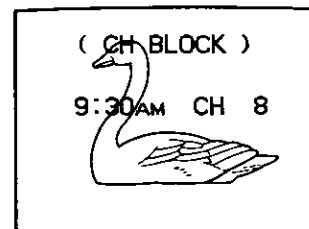
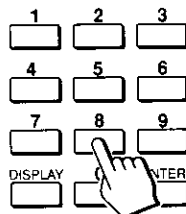

If you make a mistake, press CLEAR and proceed from step 2.

At the preset time, the picture of the selected channel will be blocked from view and the sound will be muted. The display "BLOCKED" will appear for a few seconds, then (CH BLOCK) which will remain on the screen during the time the channel is blocked. (Both displays in red)

Normal reception will resume automatically after 12 hours.

To restore normal reception while the channel is blocked, recall "BLOCK page" and press CLEAR.

The BLOCK setting blocks a specified channel for the same 12-hour period every day.

To clear the BLOCK setting, summon "BLOCK page" and press CLEAR.

To reset, clear the setting and follow the steps above from step 2.

## Setting the Program Start TIMER

Make sure that the clock has been set correctly before setting the program start TIMER. (p. 17)

**EXAMPLE:** To set the TIMER for a program which begins at 10:30 PM on channel 12

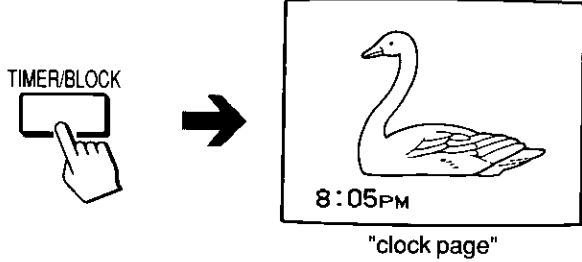
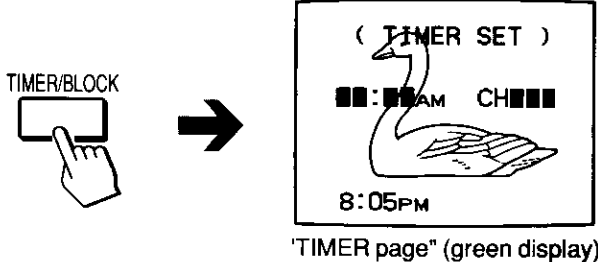
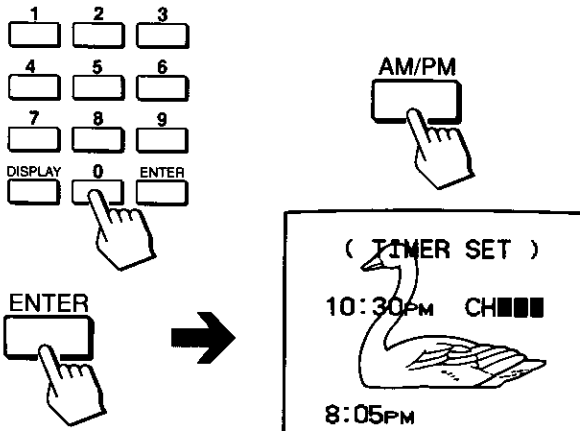
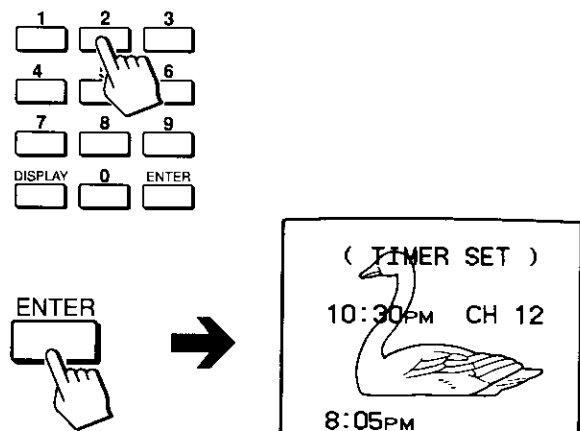
<p><b>1</b> From "NORMAL page," (no display) press TIMER/BLOCK once to change to "clock page."</p>  <p>"clock page"</p>	<p><b>2</b> Press TIMER/BLOCK again before the "AM"/"PM" indication disappears to summon "TIMER page."</p>  <p>"TIMER page" (green display)</p>
<p><b>3</b> Press 1, 0, 3, 0, AM/PM, ENTER. The screen display will blink once, indicating that the time has been set.</p>  <p>The TIMER lamp will light up, indicating that the TIMER has been set.</p>	<p><b>4</b> Press 1, 2, ENTER (0 not necessary). The screen display will blink once, indicating that the channel has been set.</p> 

**If you make a mistake,** press CLEAR and proceed from step 3.

**At the preset time,** the selected channel will appear on the screen and the TIMER lamp will go out. The TIMER will operate whether you are watching a TV program or a VCR playback, or even if the TV is turned off.

**If no button is pressed within 2 hours after the preset time,** an "OFF" display will appear on the screen for 1 minute. If a button is still not touched during that minute, the TV will turn off automatically as a safety precaution.

The TIMER operates only once, but the time and the channel will remain in the TV's memory.

**To preset the same channel at the same time for a future date,** press OFF/REPEAT. The TIMER lamp will light up, indicating that the TIMER has been reactivated.

**To deactivate the TIMER,** press OFF/REPEAT again so that the TIMER lamp goes out. It is not necessary to summon "TIMER page" before using the OFF/REPEAT button. Furthermore, this button is effective even if the TV is turned off.

**To clear the TIMER setting,** summon "TIMER page" and press CLEAR.

**To reset,** clear the setting and follow the steps from step 3.

# Other Useful Features

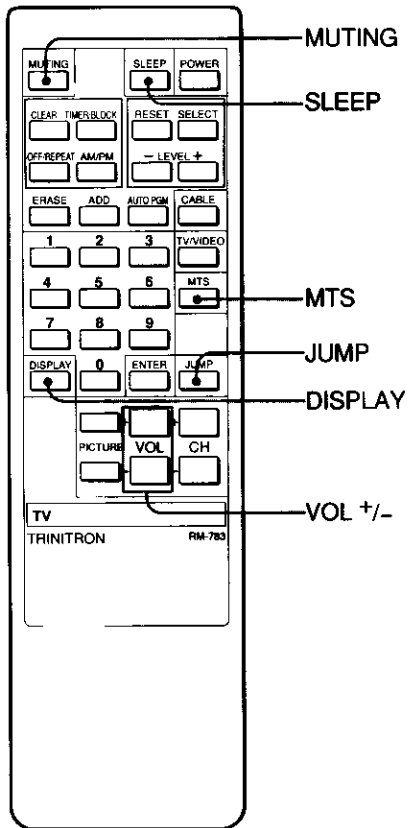

RM-783

## Muting the sound – MUTING button

1. Press MUTING.
2. The display "MUTING" will appear on the screen.
3. To restore the sound, press MUTING again, or press VOL +.

## Using the SLEEP timer – SLEEP button

TO SET: (Turns TV off automatically about 1 hour after setting)

1. Press SLEEP.
2. A green "SLEEP ON" display appears for a few seconds.
3. A red "SLEEP" display will appear 1 minute before the TV shuts off.

TO CANCEL:

Press SLEEP again.

A green "SLEEP OFF" display appears for a few seconds.

OR

Turn the TV off. The sleep timer setting will be cancelled.

## Receiving a Multichannel TV Sound Program – MTS button (KV-20TS27, KV-2137RS only)

Each time you press MTS, the MAIN, SAP (Second Audio Program) and MONO modes are selected in sequence. The display (in green) for each mode will appear on the screen for a few seconds.

(NOTE: During SAP mode, the sound of non-SAP programs will be muted.)

TO LISTEN TO STEREO SOUND:

1. Press MTS to select the MAIN mode.
2. The MAIN display will appear on screen.
3. The STEREO indicator lamp on the TV will light up whenever a stereo broadcast is received.

NOTE: A weak incoming signal may cause excessive noise with some stereo broadcasts.

Switch to MONO mode to eliminate this noise.

## Switching quickly between 2 channels – JUMP button



Each time you press the JUMP button, the channel which appeared on the screen immediately before is recalled. Use this feature to keep track of two programs alternately.

## Keeping the channel displayed – DISPLAY button



TO DISPLAY the channel:

Press DISPLAY.

The channel display will remain on the screen.

TO CANCEL the display:

Press DISPLAY again.

The channel display will disappear.

# Connecting Optional Equipment →

## Connecting a VCR

After connecting, you will be able to...

- Play back video tapes
- Record TV programs
- Record one TV program while viewing another

KV-20TS27/KV-2137RS

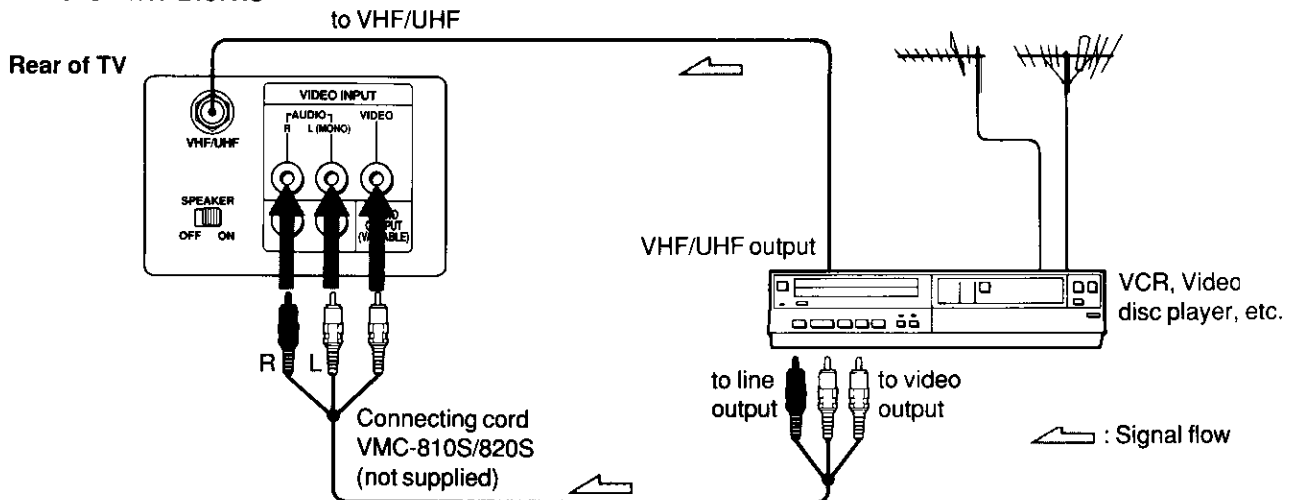

KV-20TR22/KV-2127R

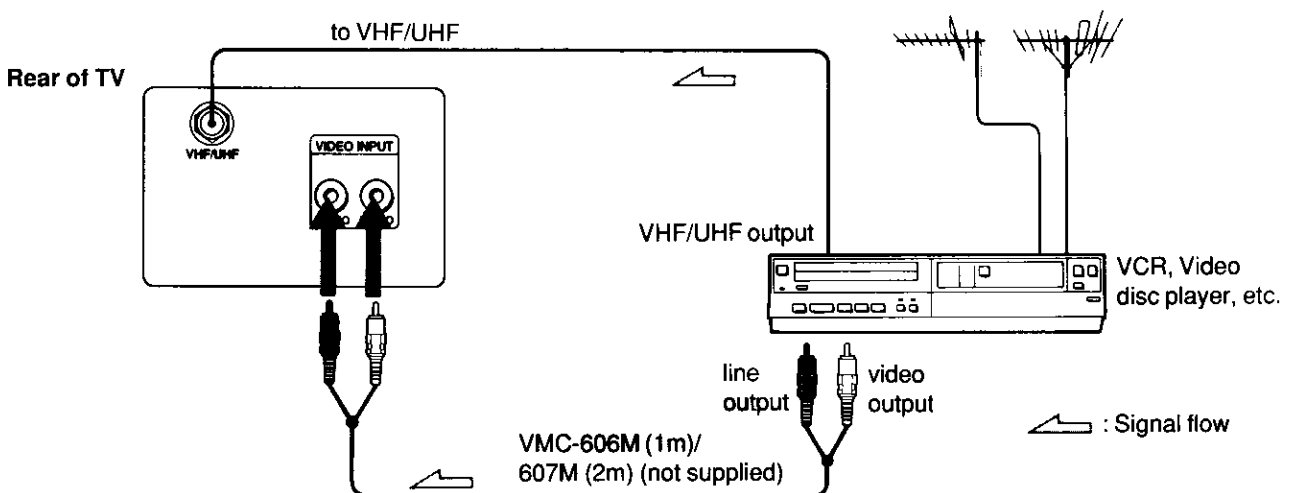

### To play back video tapes

- 1 Turn on the TV.
- 2 Press the TV/VIDEO button so that the "VIDEO" display appears on the screen.
- 3 Set the VCR in playback mode.

### To return to the TV mode

Press the TV/VIDEO button until a channel number appears on the screen.

- If you connect a monaural VCR, connect the audio output of the VCR to the L jack of the TV. The monaural sound is heard from both speakers.
- For operating instructions, refer to the instruction manual furnished with the VCR.
- If the picture or sound is affected, move the VCR away from the TV.
- When the TV is in the video mode, "VIDEO" will appear on the screen, even when no signal is being received through the VIDEO INPUT jacks.

# Connecting Optional Equipment (cont'd. from p. 21)

The AUDIO OUTPUT jacks are included only with models KV-20TS27 and KV-2137RS.

## Connecting an Audio System

KV-20TS27/KV-2137RS

To listen to the TV or connected VCR sound through an audio system

Rear of TV

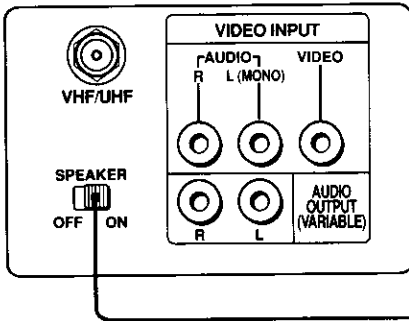

When an audio system is connected to **AUDIO OUTPUT**, be sure to set the **SPEAKER** switch at the rear of the TV to **OFF**. The sound from the TV's speakers will be cut off.

To adjust sound level

Leave the amplifier volume, bass and treble controls at their mid position, and adjust the level with the **VOLUME +/-** buttons on the TV or the **VOL +/-** buttons on the Commander.

Rear of TV

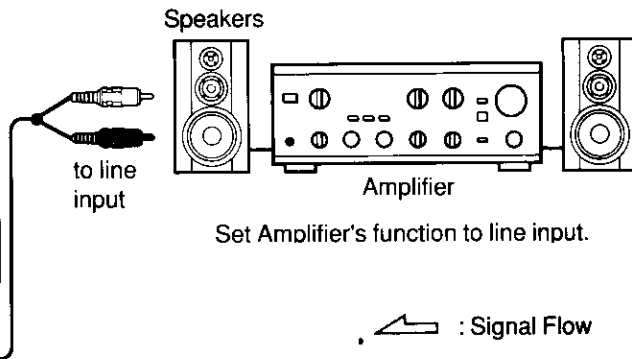
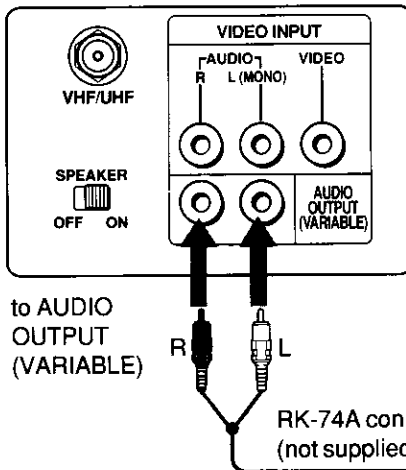

# Specifications

<b>Television system</b>	American TV standards
<b>Channel coverage</b>	VHF: 2 - 13 UHF: 14 - 69 Cable TV: 1 - 125
<b>Picture tube</b>	Microblack™ Trinitron tube <b>20-inch picture measured diagonally</b> 21-inch picture tube measured diagonally
<b>Antenna</b>	75-ohm external antenna terminal for VHF/UHF
<b>Input</b>	VIDEO INPUT (phono jacks) Video: 1Vp-p, 75-ohms unbalanced, sync negative Audio: 500 mVrms (100% modulation) Impedance: 10 kilohms
<b>Output</b> (KV-20TS27, KV-2137RS only)	AUDIO OUTPUT (VARIABLE) (phono jacks) More than 408 mVrms at the maximum volume setting (variable) (100% modulation)
<b>Power requirements</b>	120 V AC, 60Hz
<b>Power consumption</b>	125 W (Max.) 5 W (in standby condition)
<b>Dimensions</b>	527.0 x 488.5 x 482.0 mm(W/H/D) (20 3/4" x 19 1/4" x 19")
<b>Weight</b>	KV-20TS27, KV-2137RS: 23.4 Kg (51 lbs 10 oz) KV-20TR22, KV-2127R: 23.1 Kg (50 lbs 15 oz)

## Supplied accessories

Model	Remote Commander
KV-20TS27	RM-783 (1)
KV-20TR22	RM-781 (1)
KV-2137RS	RM 783 (1)
KV-2127R	RM-781 (1)

with 2 size AA (R6) EVEREADY batteries

All Models	VHF/UHF telescopic dipole antenna (1)*
	Antenna connector (1)

\* Except Canada

<b>Optional accessories</b>	U/V mixer EAC-66 Connecting cable VMC-606/607M VMC-810/820S RK-74A
-----------------------------	--

Designs and specifications are subject to change without notice.

# Troubleshooting

Disturbances in picture and sound can often be eliminated by checking the symptoms and following the suggestions listed below.

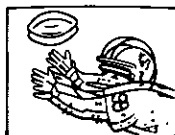
	SYMPTOM	CHECK AND ADJUST
GENERAL	<b>Poor or no picture</b> (screen not lit), good sound	<ul style="list-style-type: none"> <li>Adjust PICTURE.</li> <li>Adjust BRIGHT.</li> <li>Check antenna/cable connections.</li> </ul>
	<b>Good picture, no sound</b>	<ul style="list-style-type: none"> <li>Press VOLUME +.</li> <li>Release MUTING on the Remote Commander.</li> <li>Check that the MTS button is set correctly.</li> <li>Check that the TV/VIDEO button is set correctly.</li> <li>Set the SPEAKER switch to ON.</li> </ul>
	<b>No picture</b> (screen not lit), no sound	<ul style="list-style-type: none"> <li>Is POWER switched on?</li> <li>Power in outlet?</li> <li>Check that the TV/VIDEO button is set correctly.</li> </ul>
	<b>No color</b>	<ul style="list-style-type: none"> <li>Is it a color program?</li> <li>Adjust COLOR.</li> </ul>
	<b>Snow and noise only</b>	<ul style="list-style-type: none"> <li>Is it an active or the correct channel?</li> <li>Check the CABLE selector setting.</li> <li>Check antenna/cable connections.</li> </ul>
	 <b>Dotted lines or stripes</b>	This is often caused by local interference. (e.g. cars, neon signs, hairdryers etc.) Adjust antenna for minimum interference.
 <b>Double images or ghosts</b>	Reflections from nearby mountains or buildings often cause this problem. A highly directional outdoor antenna or a CATV cable may improve the picture.	
TIMER/BLOCK	<b>Try another channel.</b> It could be station trouble.	
	<b>Program start TIMER and/or channel BLOCK does not operate properly.</b>	<ul style="list-style-type: none"> <li>Is the clock set correctly?</li> <li>Is the setting correct?</li> <li>Have you unplugged the TV?</li> <li>Has a power failure occurred? If so, the settings have been erased.</li> </ul>

If the problem persists, contact your nearest service facility.