

SAN FRAN
1/4

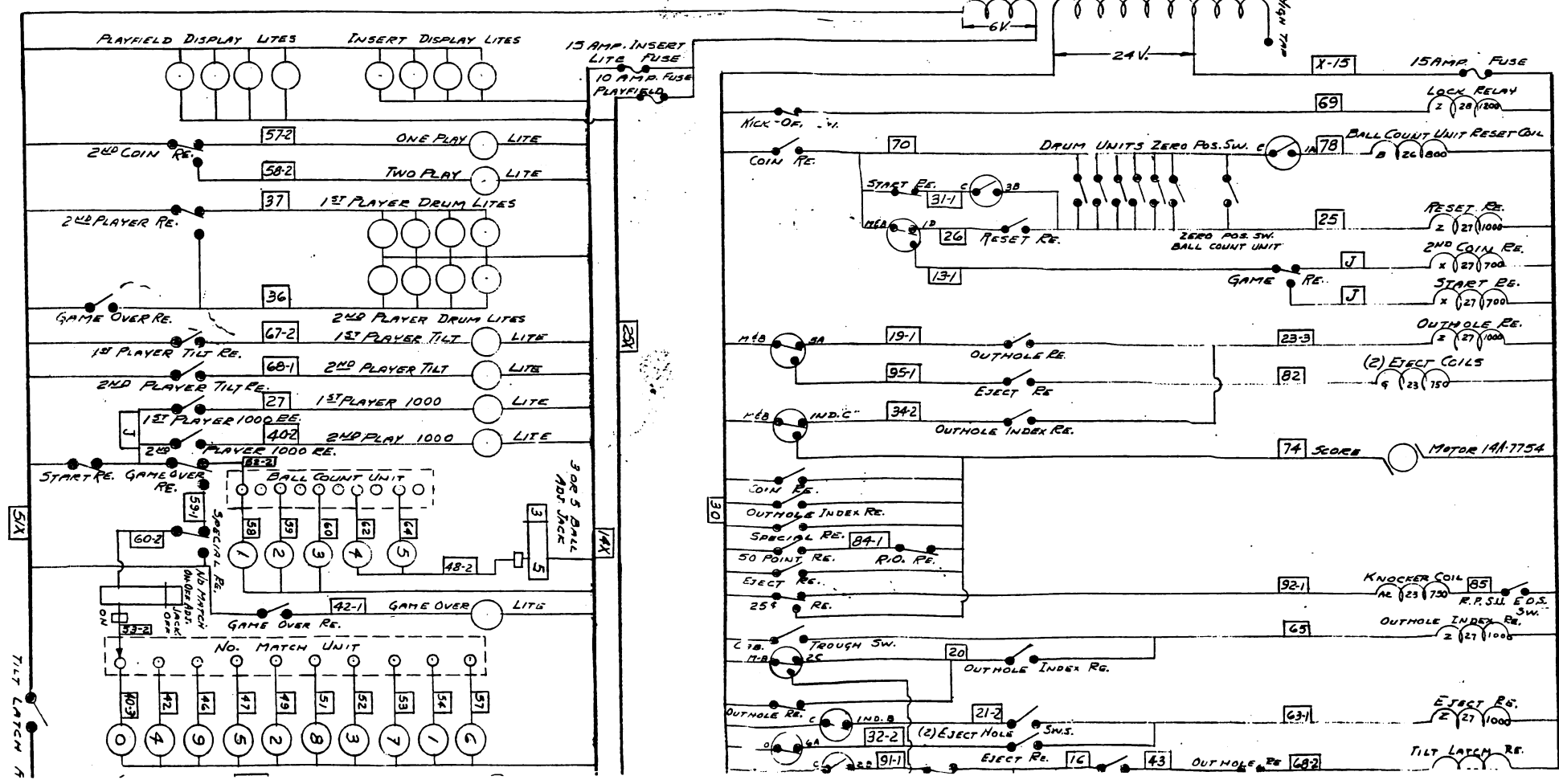

SAN
FRAN
2/4

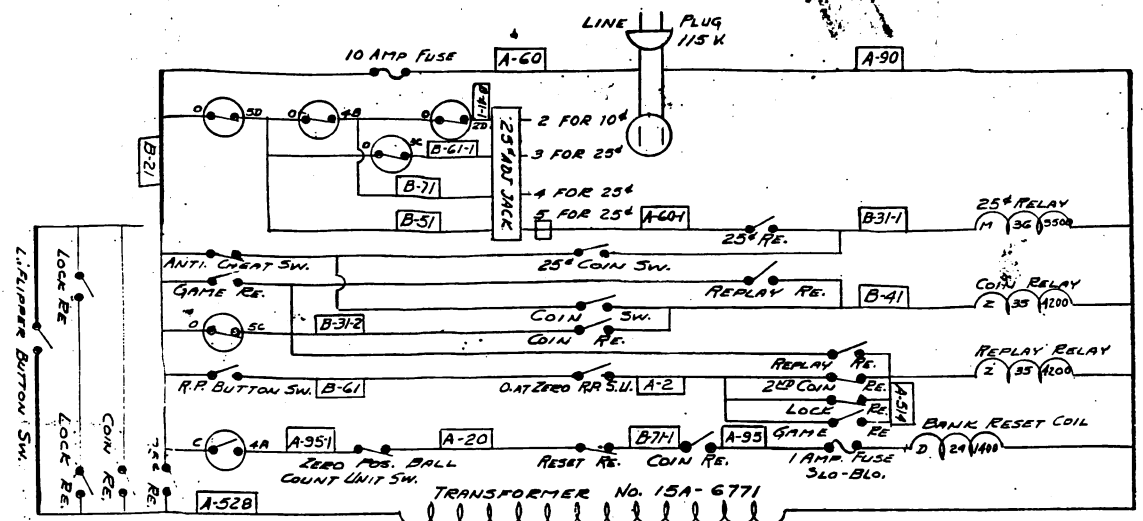
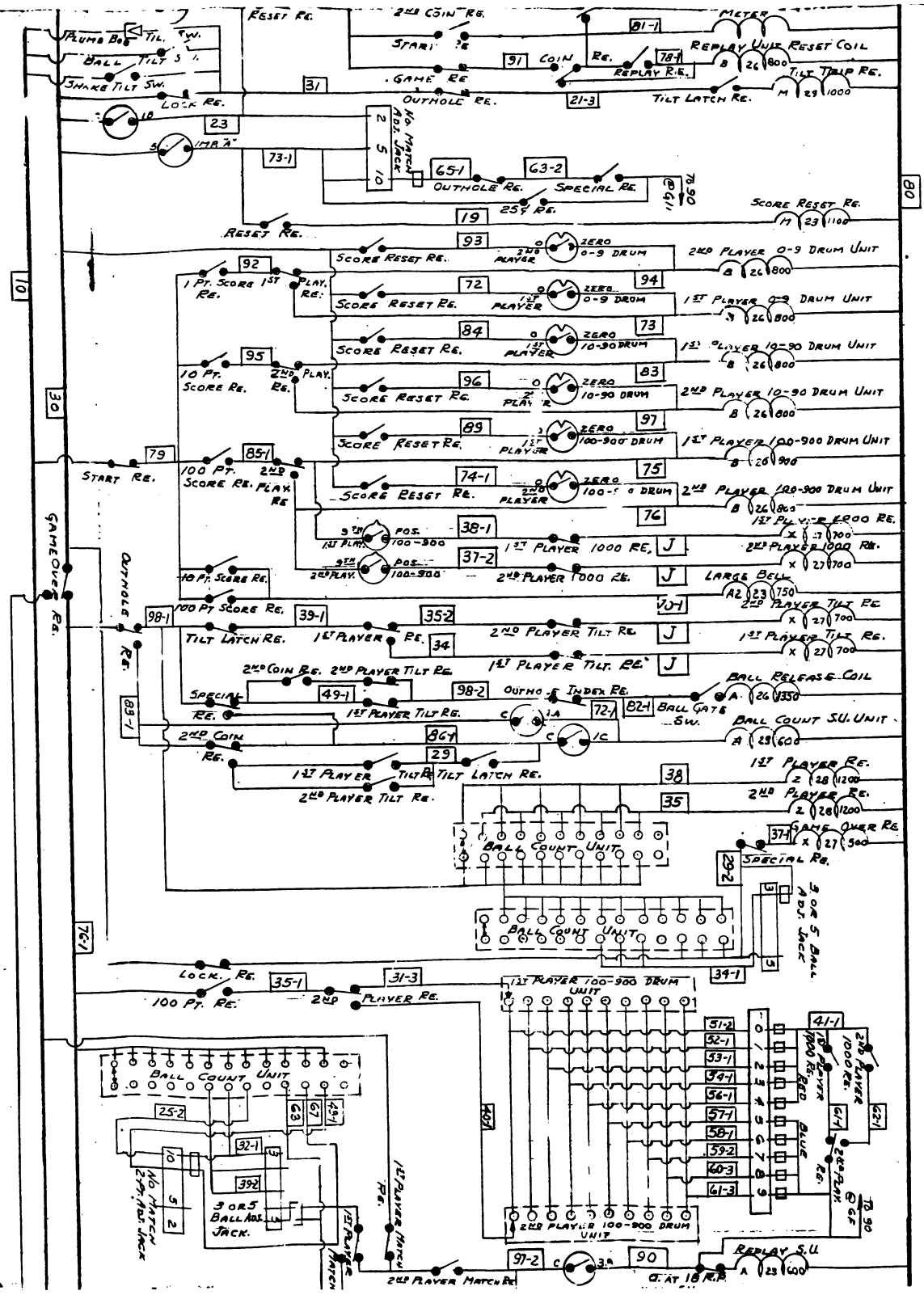
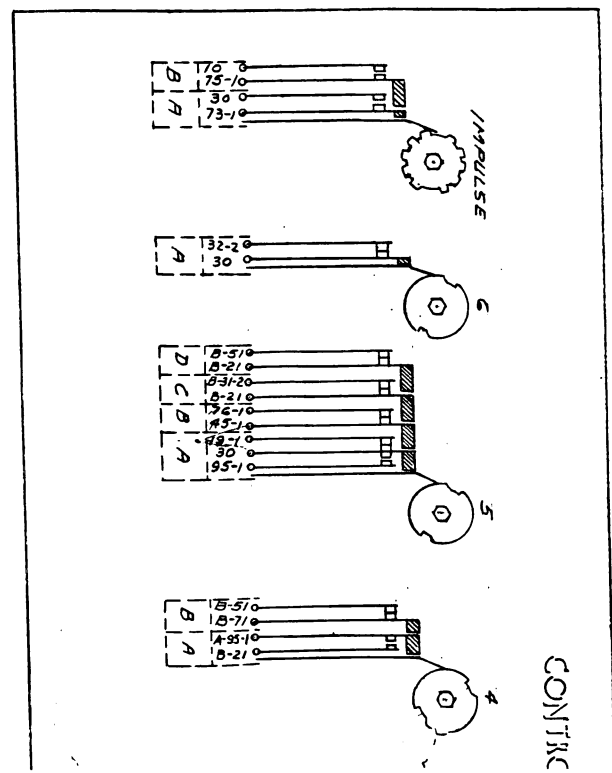
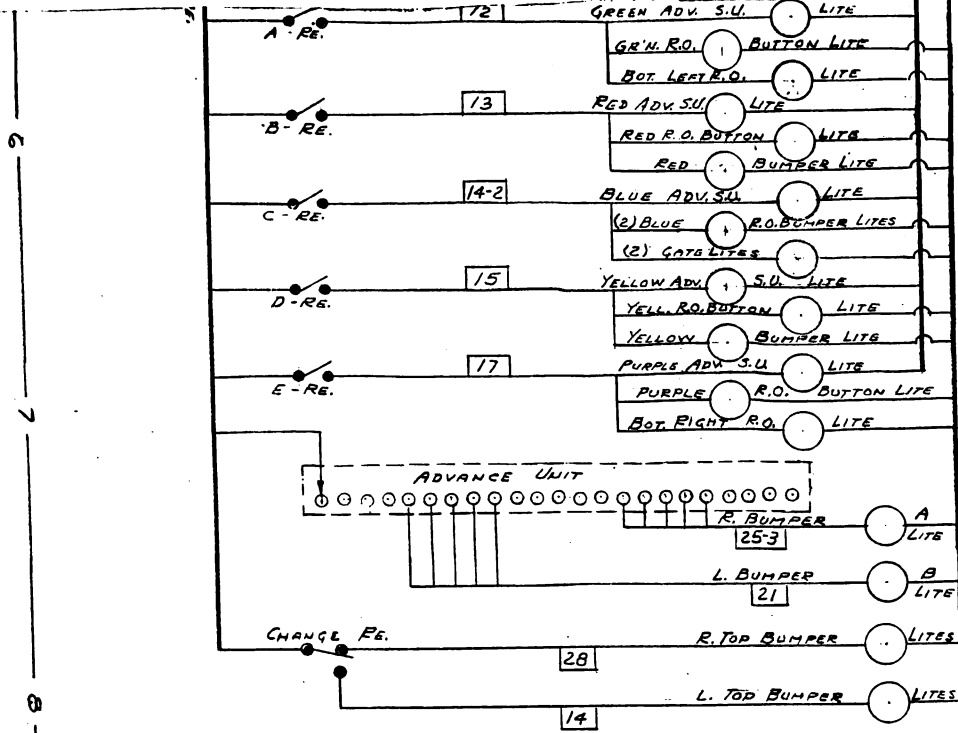

SAN FRAN
3/4

12
13
14
15
1C

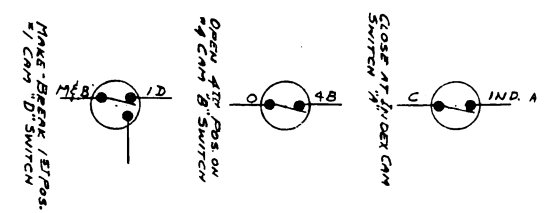
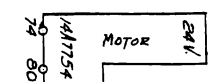
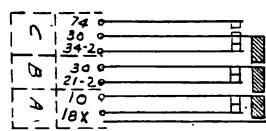
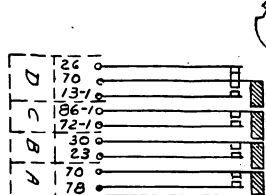
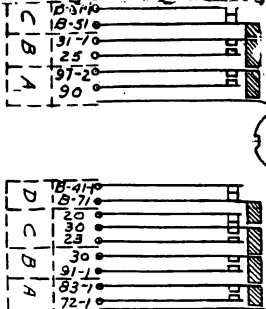
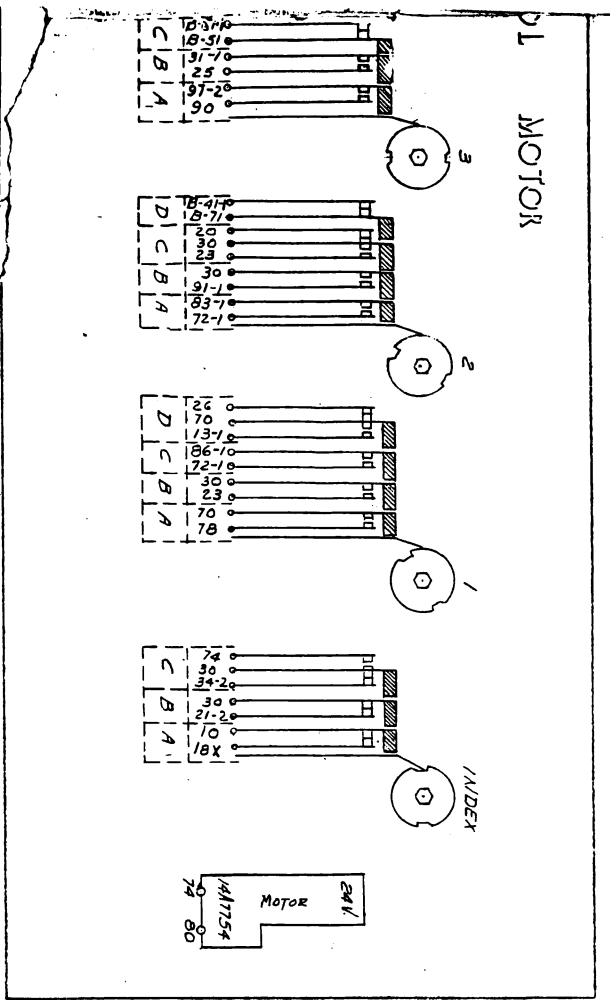

WHITE COLOR CODE	WIRE COLOR CODE
1. RED	1. FIRST A
2. BLUE	2. SECOND A
3. YELLOW	3. THIRD A
4. GREEN	Reuse of
5. WHITE	EXACT
7. ORANGE	10 = RED
8. BLACK	15 = RED-14
9. GREY	90 = GREY
0. NO TRACER	91-1 = GREY-1
J. Jumper	

DOUBLE
A-B NO. 1
A-B NO. 2
WHEN REE

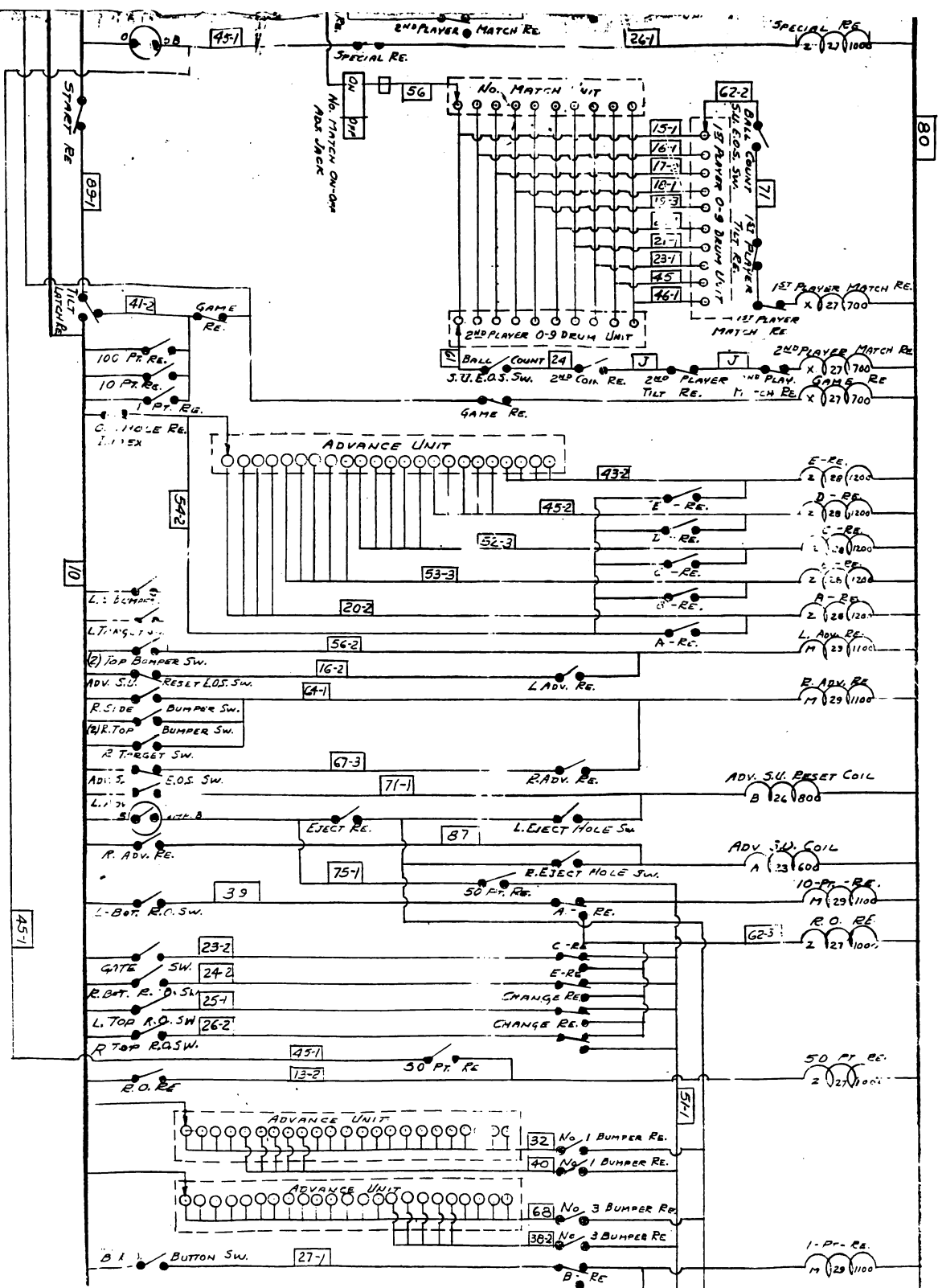

80

10

45-1

1-Pr. Re.
M 28 1100

