

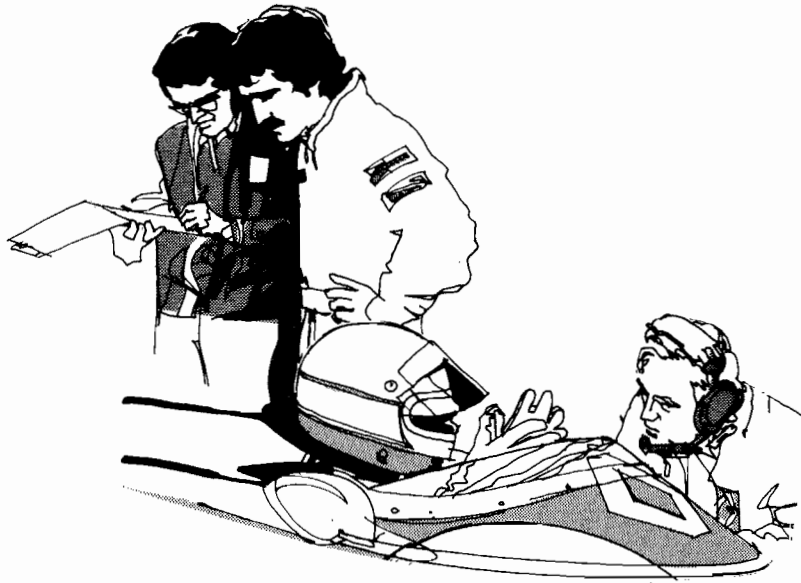

\*Pole Position and Pole Position II are engineered and designed by Namco, Ltd., manufactured under license by Atari, Inc. Trademark and © 1982, 1983.

**WARNING**  
The enhancement of any Pole Position II game should only be performed by a qualified technician.

**Enhancement Instructions**



## **Pole Position II Enhancement Instructions**



©1983 by Atari, Inc

All rights reserved.

No part of this publication may be reproduced by any mechanical, photographic, or electronic process, or in the form of a phonographic recording, nor may it be stored in a retrieval system, transmitted, or otherwise copied for public or private use, without permission from the publisher.

The game play, all graphic designs, this technical manual, its accompanying schematic diagrams, and the display manual are protected by the U.S. Copyright Act of 1976.

This Act provides for increased penalties for violating federal copyright laws. Courts can impound infringing articles while legal action is pending. If infringers are convicted, courts can order destruction of the infringing articles.

In addition, the Act provides for payment of statutory damages of up to \$250,000 in certain cases. Infringers may also have to pay costs and attorneys' fees and face an imprisonment of up to five years.

Atari will aggressively enforce its copyrights against any infringers. We will use all legal means to immediately halt any manufacture, distribution, or operation of a copy of video games made by us. Anyone who purchases such copies risks forfeiting such a game.

Published by: ATARI, INC.  
790 Sycamore Drive  
P.O. Box 906  
Milpitas, California 95035

Printed in the U.S.A. 10M

## TABLE OF CONTENTS

Introduction .....	1
Enhancement Kit Inventory.....	3
Tools Required for Enhancement.....	5
Enhancement Procedure for the Upright Game.....	7
Replace the Attraction Glass.....	7
Replace the Display Shield.....	7
Remove the Printed-Circuit Boards.....	8
Modify the Printed-Circuit Boards.....	9
Set the Option Switches.....	22
Install the Printed-Circuit Boards.....	23
Install the Decals.....	23
Install the Self-Test Chart.....	25
Perform a Self-Test.....	25
Change the Pole Position Schematic Package.....	25
Enhancement Procedure for the Sit-Down Game.....	27
Replace the Display Shield.....	27
Remove the Printed-Circuit Boards.....	28
Modify the Printed-Circuit Boards.....	28
Set the Option Switches.....	28
Install the Printed-Circuit Boards.....	29
Install the Decals.....	29
Install the Self-Test Chart.....	32
Perform a Self-Test.....	32
Change the Pole Position Schematic Package.....	32

## LIST OF ILLUSTRATIONS

Figure 1	Parts Affected by Enhancement Procedure.....	2
Figure 2	Attraction Glass and Display Shield Replacement— Upright.....	6
Figure 3	Atari PCB Components Affected by Enhancement.....	10
Figure 4	NAMCO PCB Components Affcted by Enhancement.....	11
Figure 5	Removing ICs (Cut Pin Method).....	14
Figure 6	Removing IC Pins.....	14
Figure 7	Removing Solder from Plated-Through Holes.....	14
Figure 8	Removing Solder from Lead Connection Pads.....	14
Figure 9	Removing an IC from a Socket.....	16
Figure 10	Display Shield Replacement—Sit-Down.....	26

## LIST OF TABLES

Table 1	Enhancement Kit Contents—Upright.....	3
Table 2	Enhancement Kit Contents— Sit-Down.....	4
Table 3	Tools Required for Enhancement.....	5
Table 4	Atari CPU PCB Component Locations.....	17
Table 5	IC Socket Locations on the Atari Video PCB.....	18
Table 6	Atari Video PCB Component Locations.....	18
Table 7	Namco CPU PCB Component Locations.....	19
Table 8	IC Socket Locations on the Namco Video PCB.....	20
Table 9	Namco Video PCB Component Locations.....	21
Table 10	Factory-Recommended Settings for Play Options.....	22
Table 11	Factory-Recommended Settings for Price and Play Options...	22

### INTRODUCTION

Pole Position II, the sensational sequel to Pole Position, offers you a choice of four racetracks! The tracks—FUJI, TEST, SUZUKA, and SEASIDE—are based on actual international raceways. The following instructions will help you change a Pole Position upright or sit-down game into a Pole Position II game. These modifications include changing the attraction glass (upright), changing the display shield, changing certain printed-circuit board (PCB) components, posting decals, and installing a new self-test chart. Figure 1 shows parts of the cabinet that are affected by these modifications.

### SUPPORTING DOCUMENTATION

These instructions are designed to be used with the following documentation:

- TM-218 Pole Position Operation, Maintenance, and Service Manual
- ST-255 Pole Position II Self-Test Chart
- CO-218-12 Pole Position II Operator Information
- SP-218 Pole Position Schematic Package or
- SP-219 Pole Position Schematic Package

After you have followed the instructions in this document, refer to CO-218-12 for additional information on Game Play, Self-Test, Option Switch Settings, and Schematic Package changes.



WARNING



Before you start the enhancement procedures,  
UNPLUG THE GAME.

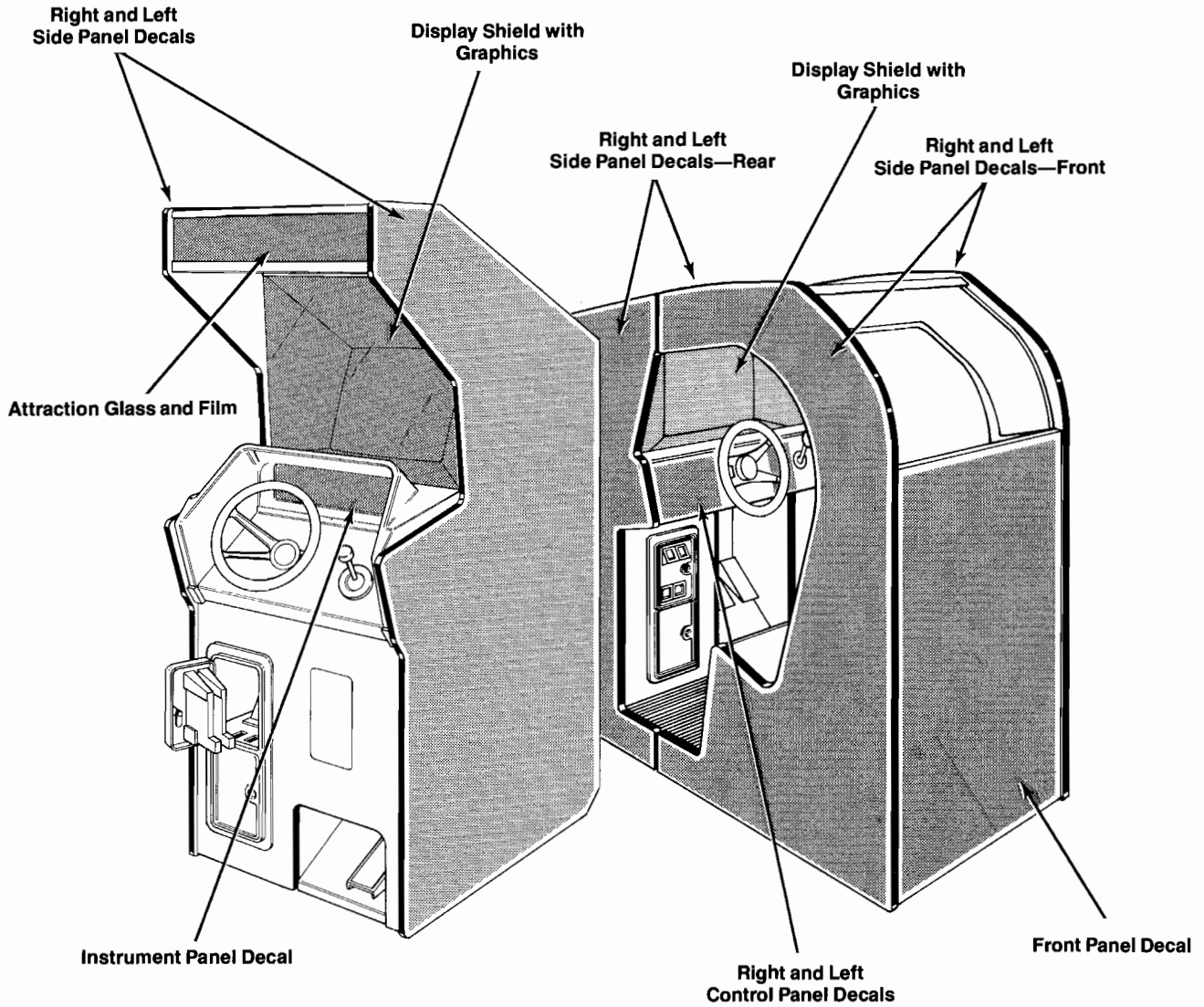

**CPU and Video PCBs**  
 See Figures 3 and 4  
 Modify these PCBs with ICs  
 in the Electronics Kit.

**Self-Test Chart**  
 Includes Self-Test Informa-  
 tion and Option Switch  
 Settings—Inside the  
 Cabinet.

**Figure 1 Parts Affected by Enhancement Procedure**

ENHANCEMENT KIT INVENTORY

Before you start to modify the game, check the contents of the Pole Position II Enhancement Kit. The kit contents for upright games are listed in Table 1. The kit contents for sit-down games are listed in Table 2. If any item is missing, contact your Atari distributor. Note that the integrated circuit (IC) components included in the kit are labeled with their respective part numbers.

Table 1 Enhancement Kit Contents--Upright  
A041351-01 C

Part No.	Quantity	Description
A041352-01	1	Electronics Kit--Includes the following:
79-42C16	5	16-Pin socket
79-42C18	2	18-Pin socket
79-42C28	7	28-Pin socket
136014-166--192	27	Integrated circuits
137351-001	1	Pole Position II custom integrated circuit
CO-218-12	1	Pole Position II Operator Information
CO-218-13	1	Pole Position II Decal Mailer Card
ST-255	1	Self-test chart
78-6900404	50 inches	1/4-Inch wide x 1/4-inch thick black foam tape (coated on 1 side)
037410-01	1	Attraction glass
041353-01	1	Left side-panel decal*
041353-02	1	Right side-panel decal*
041354-02	1	Attraction panel film
041355-03	1	Instrument panel decal
041356-01	1	Video display shield with graphics
041377-01	2	Printed-circuit board label
041530-01	2	Caution label

\*The left and right-side panel decals are optional. Use the mailer card provided to receive your free decals.



Table 2 Enhancement Kit Contents—Sit-Down  
A041376-01 C

Part No.	Quantity	Description
A041352-01	1	Electronics Kit—Includes the following:
79-42C16	5	16-Pin socket
79-42C18	2	18-Pin socket
79-42C28	7	28-Pin socket
136014-166--192	27	Integrated circuits
137351-001	1	Pole Position II custom integrated circuit
CO-218-12	1	Pole Position II Operator Information
ST-255	1	Self-test chart
78-6900404	24 inches	1/4-Inch wide x 1/4-Inch thick black foam tape (coated on 1 side)
041377-01	2	Printed-circuit board label
041378-01	1	Left side-panel decal (rear)
041378-02	1	Right side-panel decal (rear)
041379-01	1	Left side-panel decal (front)
041379-02	1	Right side-panel decal (front)
041380-04	1	Left control panel decal
041380-05	1	Right control panel decal
041381-01	1	Video display shield with graphics
041382-01	1	Front panel decal
041530-01	2	Caution label

## Tools Required for Enhancement

The tools listed in Table 3 (or their equivalents) are required to complete this modification.

Table 3 Tools Required for Enhancement

Quantity	Description	Purpose
1	1/8-inch Allen wrench	Install attraction glass
1	Diagonal cutters	Remove PCB components
1	Needle-nose pliers	Install PCB components
1	Solder sucker	Remove solder from PCB
1	Solder wick	Remove excess solder from leads
1	Isopropyl alcohol	Clean flux and debris from PCB
1	Acid brush	Clean flux and debris from PCB
1	Phillips-head screwdriver	Remove access panel and PCB
1	15 to 27 W soldering iron	Install PCB components
	masking tape	Install decals
	squeegee	Install decals
	stapler	Install self-test chart

## NOTE

Modification instructions for the upright cabinet begin on page 7; modification instructions for the sit-down cabinet begin on page 27.

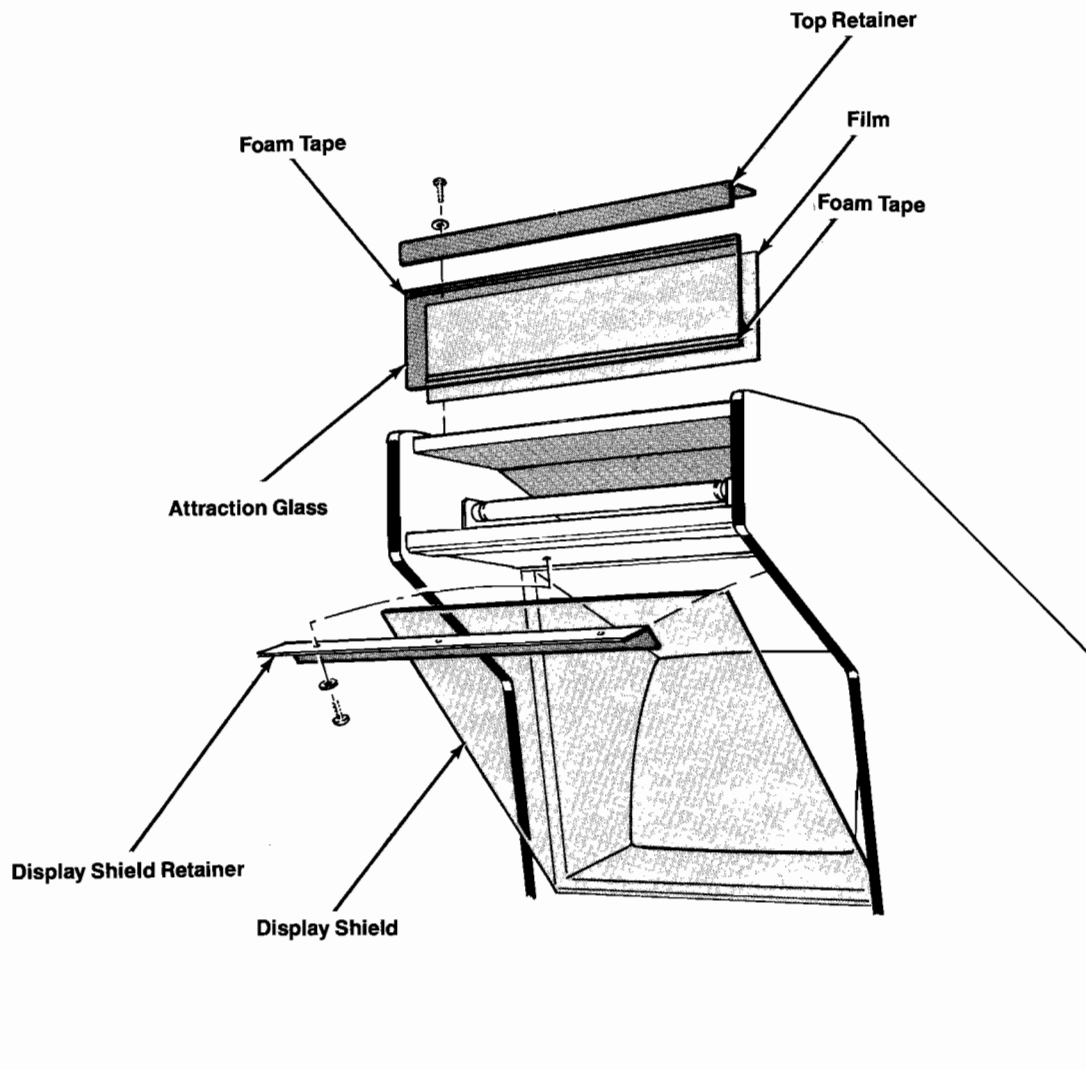

**Figure 2 Attraction Glass and Display Shield Replacement**

ENHANCEMENT PROCEDURE FOR THE UPRIGHT GAME

WARNING



These procedures must be performed by qualified service personnel. UNPLUG THE GAME before starting the following procedures.

REPLACE THE ATTRACTION GLASS

This procedure is illustrated in Figure 2.

1. Use the 1/8-inch Allen wrench to remove the three screws and washers that fasten the top retainer to the cabinet. Remove the retainer. Save the retainer, washers, and screws for reassembly.
2. Loosen the three screws that fasten the bottom retainer to the cabinet.
3. Remove and discard the attraction glass. If there is a film behind it, remove and discard the film also.
4. Take the attraction glass, attraction film, and foam tape out of the enhancement kit. Place a strip of foam tape lengthwise along the top and bottom of the attraction glass. The tape on the glass should be toward you.
5. Put the attraction film behind the attraction glass. You should be able to read the film. Place the attraction glass and film in the bottom retainer.
6. Tighten the screws in the bottom retainer.
7. Reinstall the top retainer, using the washers and screws you saved in step 1.

REPLACE THE DISPLAY SHIELD

This procedure is also illustrated in Figure 2.

1. Use the 1/8-inch Allen wrench to remove the screws and washers that hold the display shield retainer in place. Save this hardware for reassembly.
2. Lift the display shield out of the cabinet.
3. Install the display shield contained in the enhancement kit.

4. Reinstall the display shield retainer with the hardware you saved in step 1.

#### REMOVE THE PRINTED-CIRCUIT BOARDS

See TM-218 (Figures 1-1 and 1-2) for the location of the Central Processing Unit (CPU) printed-circuit boards (PCB) and the Video PCB.

#### NOTE

If your game was built in the United States of America, the CPU and Video printed-circuit boards are attached to an Electromagnetic Interference (EMI) Shield printed-circuit board. If your game was built in Ireland, it will NOT have the EMI Shield printed-circuit board.

1. Open the access panel at the rear of the game.
2. Disconnect the two edge-connectors from the game PCB set. If your game has an EMI Shield PCB:
  - a. Disconnect the two edge-connectors from the EMI Shield PCB.
  - b. Pull the eight snap-in fasteners on the EMI Shield PCB to the unlocked position.

#### CAUTION

Be careful not to twist the printed-circuit boards as you remove them! If you do, components or connections may be loosened.

3. Carefully slide the PCB set straight out of its guides.
4. Carefully remove the EMI Shield PCB from the Video and CPU boards.
5. Put the printed-circuit boards on a clean work surface.

MODIFY THE PRINTED-CIRCUIT BOARDS

## CAUTION



To avoid damage to the printed-circuit boards, remove them from the game before you attempt any modifications. Refer to "Remove the Printed-Circuit Boards" procedure given previously. Also, perform modifications only with the printed-circuit boards on a clean work surface.

To determine whether your printed-circuit board (PCB) set was designed by Atari or Namco, compare the PCB outlines with those shown in Figures 3 and 4. If you are modifying an Atari PCB set as shown in Figure 3, perform the procedure "Modifying the Atari PCB Set." If you are modifying a Namco PCB set as shown in Figure 4, perform the procedure "Modifying the Namco PCB Set."



## CAUTION



Before modifying the printed-circuit boards, read "Soldering Precautions."

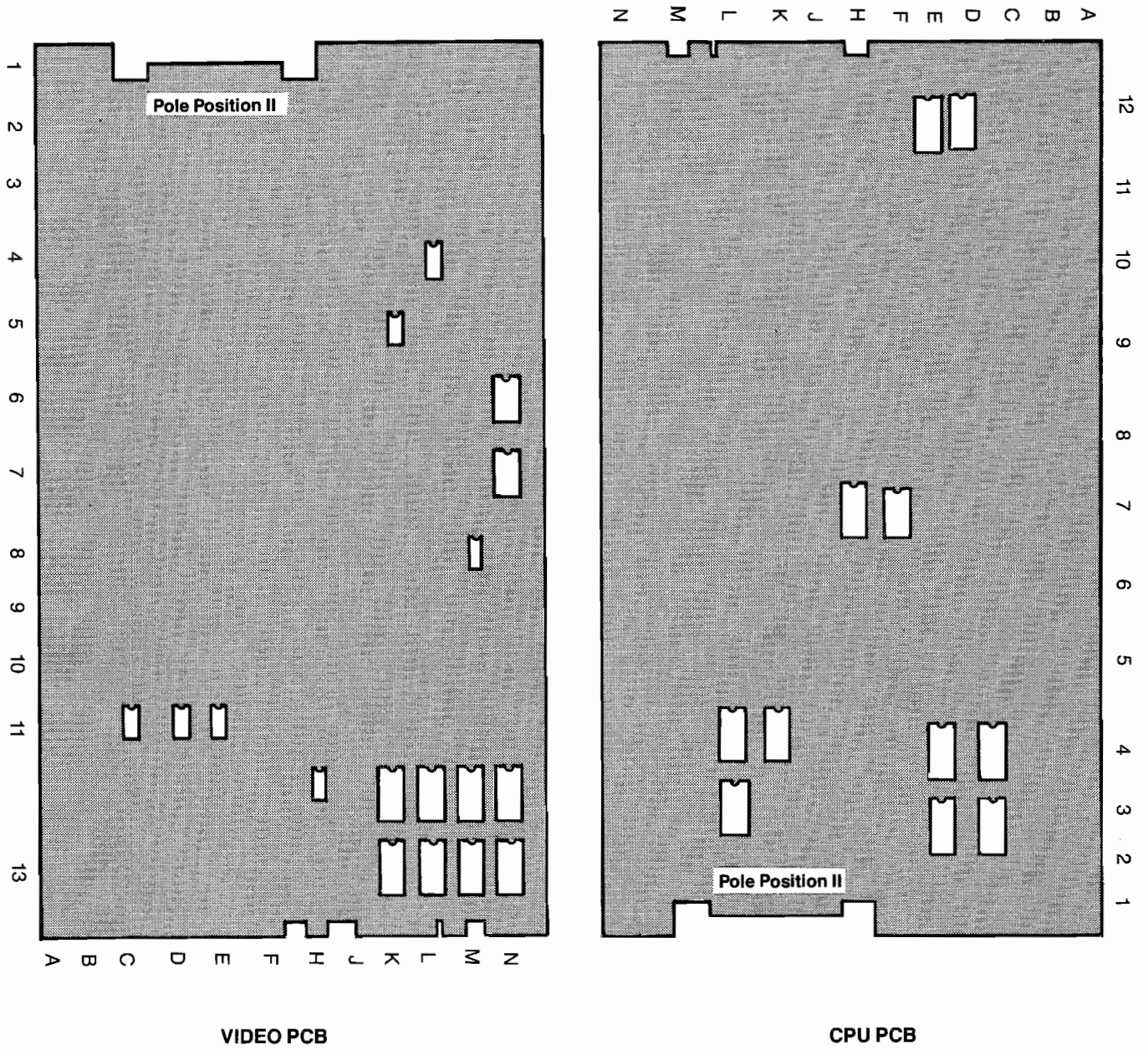

Figure 3 Atari PCB Components Affected by Enhancement

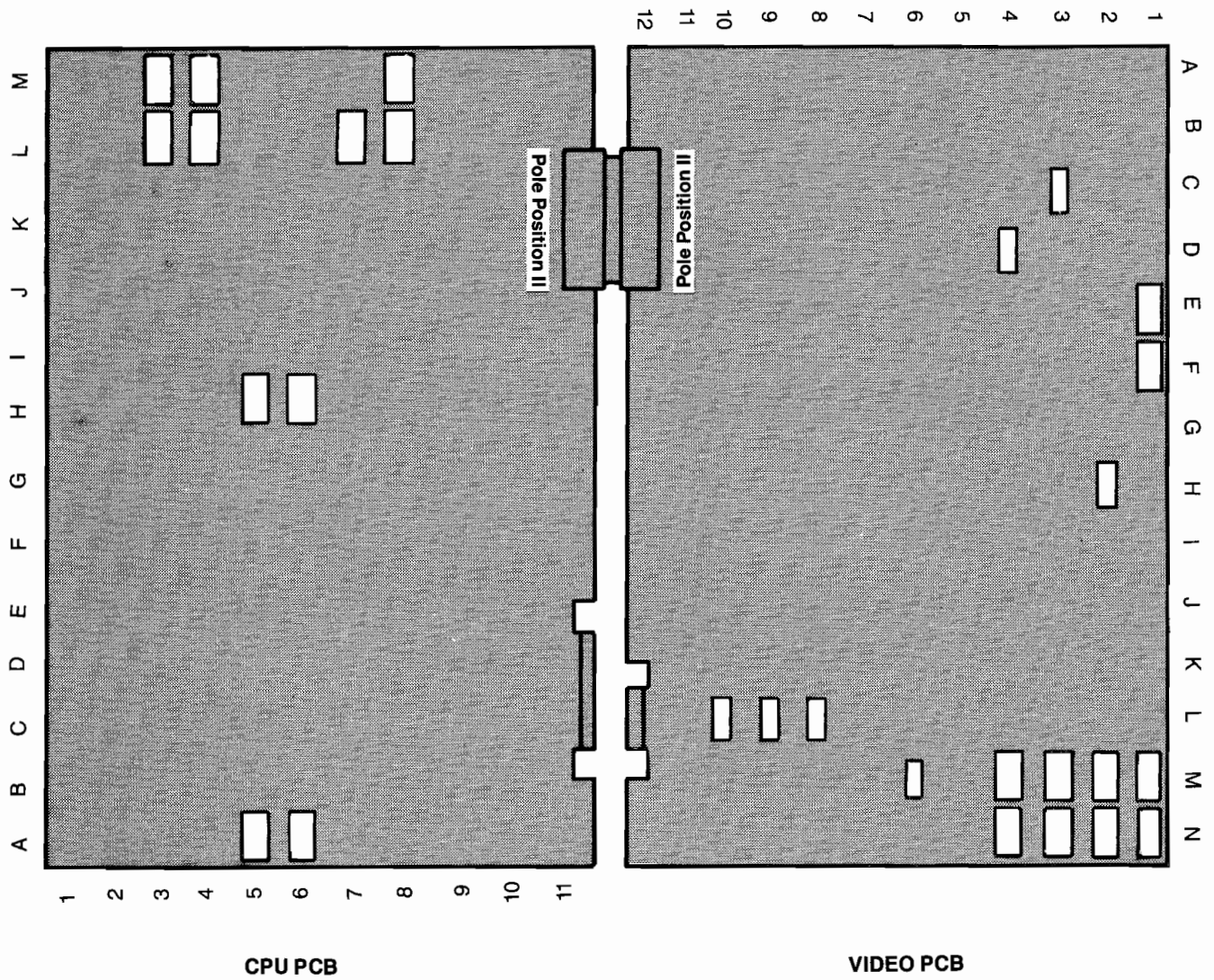

Figure 4 Namco PCB Components Affected by Enhancement



## Soldering Precautions

Soldering Techniques Observe the following recommendations when removing or installing components soldered to a PCB in this game. Poor soldering practices can damage a PCB or heat-sensitive electrical components.

Choosing the proper soldering iron is essential before attempting to remove or install soldered-in components. Excessive heat is a common cause of damage to a component or PCB. However, transient voltages from solder guns or improperly grounded soldering irons can also damage certain voltage-sensitive semiconductor devices.

A 15- to 27-watt pencil-tip soldering iron is recommended to avoid separating the etched circuit wiring from the board material and to avoid damaging active components. A temperature-controlled soldering station rated at 700°F with a fine cone or a very fine chisel tip can also be used.

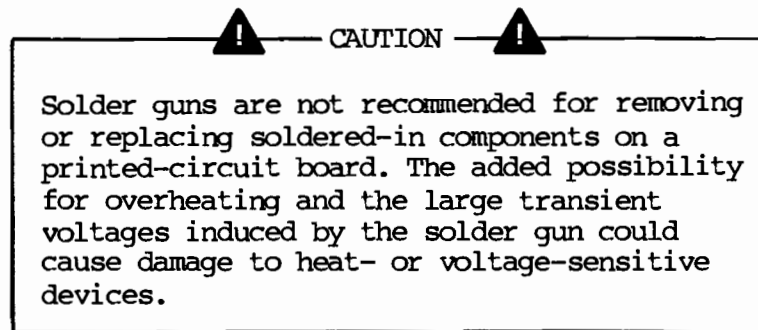

The following additional equipment is recommended for removing and installing soldered-in components:

- Solder Sucker--Hand-operated vacuum tool used to remove liquified solder from the PCB. Top-of-the-line Soldapullt® brand is recommended.
- Solder Wick--Resin-soaked copper braid used for removing excess solder from the lead connections on the PCB. See "Removing Integrated Circuits" for precautions relating to the use of a solder wick on a PCB with plated-through holes.
- Flux Remover--Non-corrosive chemical used to clean foreign material from the PCB before soldering. Also used to remove any flux residue where components have been installed and to clean any foreign material from the PCB during preventive maintenance. Isopropyl alcohol is recommended.

- Acid Brush--Small stiff-bristled paint or tooth brush used with flux remover to clean flux and other foreign material from the PCB.

Removing Integrated Circuits The easiest and safest method for removing soldered-in integrated circuits (IC) from a PCB is to cut off each pin as close to the IC case as possible with a tip dyke or diagonal cutter as shown in Figure 5.

Use the proper soldering iron as described under "Soldering Techniques." Then, to avoid excessive heat buildup in one area of the PCB, apply heat directly to each pin in a random order. Remove the loosened pin with the tip of the soldering iron or a needle-nose pliers as shown in Figure 6. Allow a moment for the PCB to cool before proceeding to the next pin. Apply just enough heat to remove any stubborn pins.

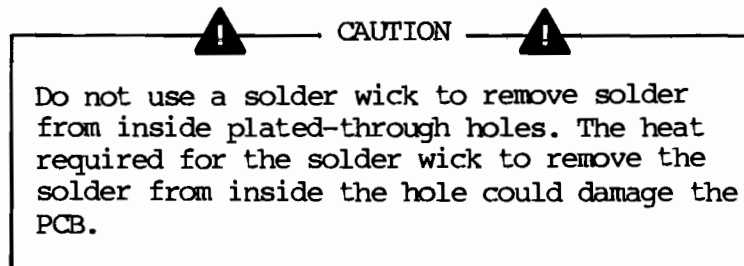

For a PCB with plated-through holes, use a solder sucker to remove the remaining solder from inside each hole as shown in Figure 7 . (If possible, suck the solder from the opposite side of the PCB from where the heat is applied.)

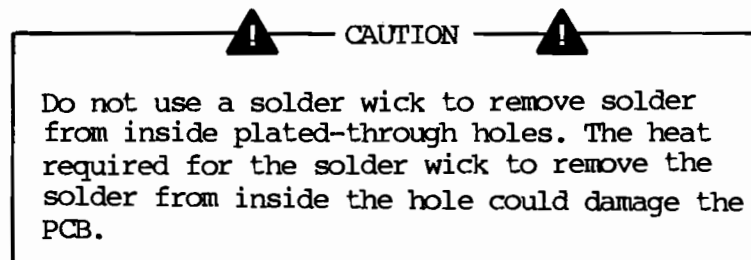

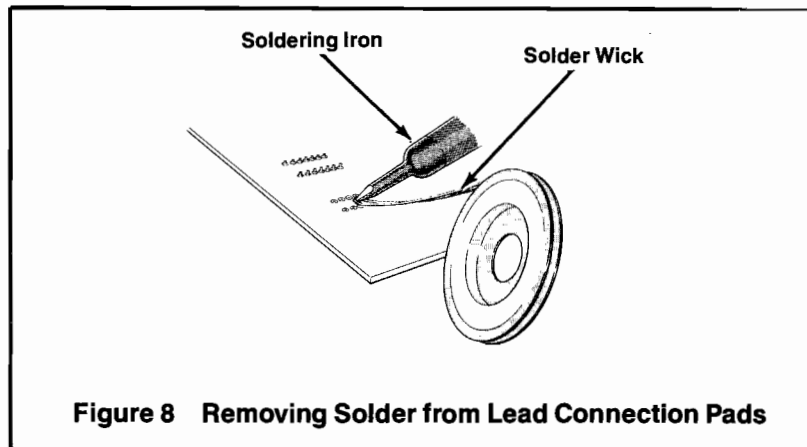
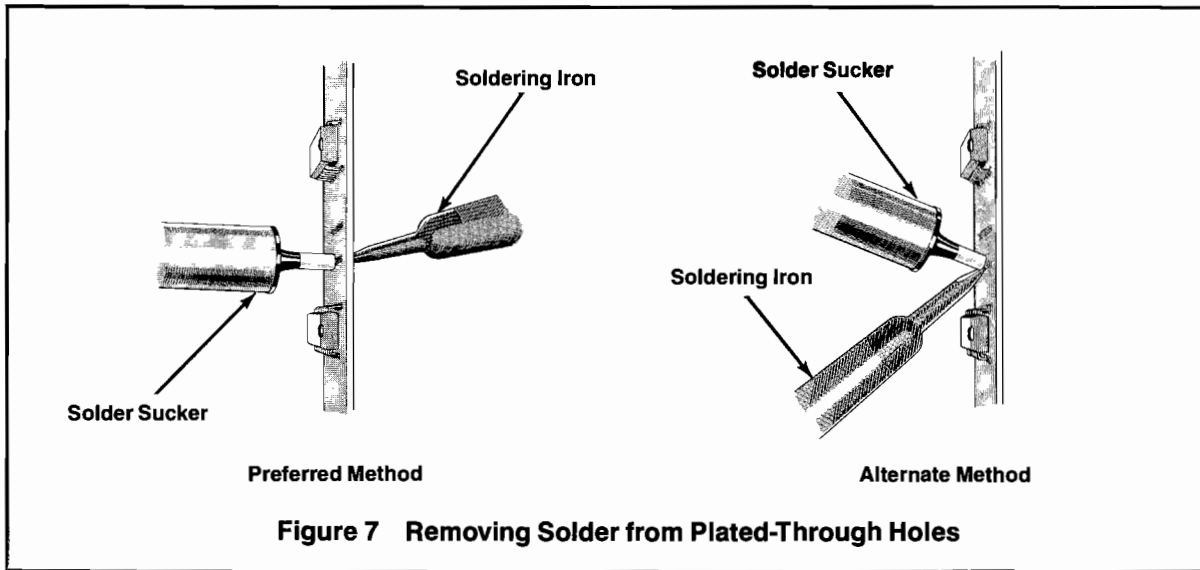
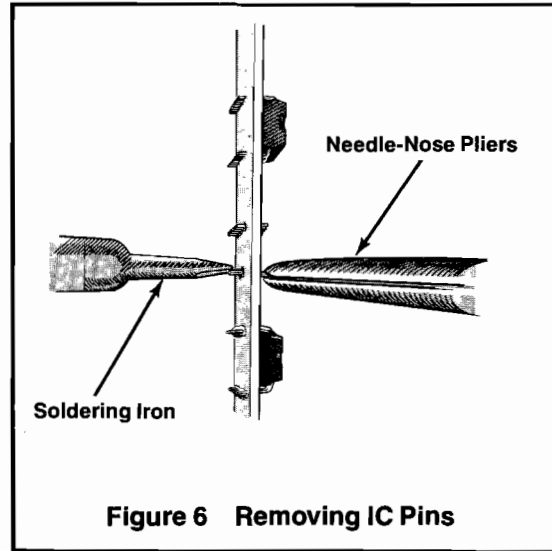
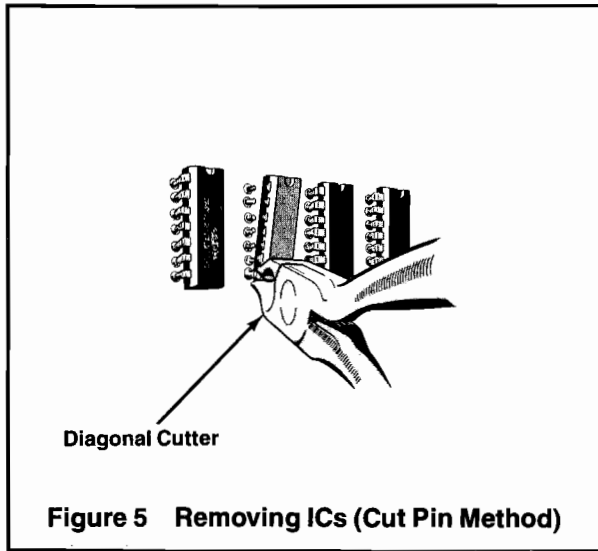

Use a solder wick to remove excess solder from around the lead connection pads on the top or bottom surface of the PCB as shown in Figure 8.

### Modifying the Atari PCB Set

Modifications to the Atari PCB set include replacing and adding integrated circuits and sockets to both the CPU PCB and the Video PCB. Be sure to observe the precautions given previously under "Soldering Precautions."

#### On the CPU PCB:

1. Using the method shown in Figure 9, remove the integrated circuits at locations 3E, 3L, 4E, 4L, 7F, 7H, 12E, and 12F from their sockets.

#### NOTE

The more recently produced Pole Position boards were manufactured to accommodate the parts in this enhancement kit. Therefore, your game CPU PCB may already have IC sockets at locations 3D, 4D, and 4K. If so, omit steps 2 and 3 and continue with step 4.

2. Using the proper soldering techniques, remove the solder from the plated-through holes at locations 3D, 4D, and 4K.
3. Remove three 28-contact IC sockets from the enhancement kit and install them on the PCB at locations 3D, 4D, and 4K. Be sure to observe the proper placement of the socket index as shown on the PCB.
4. Using the information given in Table 4, remove each specified IC from the enhancement kit and install it in the proper socket.

1. Insert screwdriver tip under body of IC.

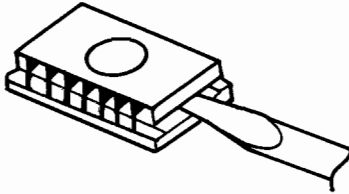

2. Gently pry IC upward.

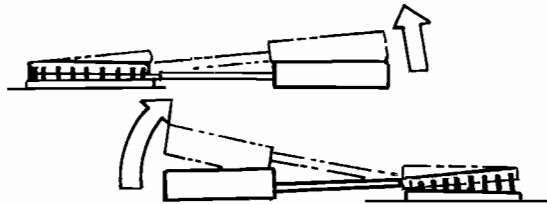

3. Insert screwdriver tip under other side of body and gently pry upward.

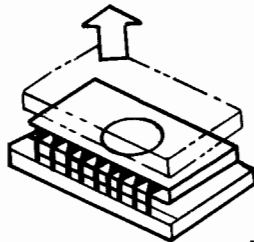

4. Lift IC out of socket.

Figure 9 Removing ICs from a Socket

Table 4 Atari CPU PCB Component Locations

IC Part No.	CPU PCB Location
136014-176	3L
136014-177	4L
136014-178	3E
136014-179	4E
136014-180	7H
136014-181	12F
136014-182	12E
136014-183	7F
136014-184	3D
136014-185	4D
137351-001	4K

On the Video PCB:

1. Using the method shown in Figure 9, remove the integrated circuits at locations 6N, 7N, 12K, 12L, 13K, 13L, and 13N from their sockets.
2. Using the method given under "Removing Integrated Circuits," remove the soldered-in IC at locations 4L, 5K, 8M, 11C, 11D, 11E, and 12H.
3. Remove the 24-contact IC sockets from the PCB at locations 6N and 7N.
4. Using the information given in Table 5, remove the appropriate IC sockets from the enhancement kit and install each in the specified location.

Table 5 IC Socket Locations on the Atari Video PCB

No. of Contacts	Install at Location:
16	5K
16	8M
16	11C
16	11D
16	11E
18	4L
18	12H
28	6N
28	7N
28	12M
28	13M

5. Using the information given in Table 6, remove each specified IC from the enhancement kit and install it in the proper socket.

Table 6 Atari Video PCB Component Locations

IC Part No.	Video PCB Location
136014-166	13K
136014-167	12K
136014-168	13L
136014-169	12L
136014-170	13N
136014-171	12N
136014-172	7N
136014-173	6N
136014-174	12M
136014-175	13M
136014-186	11E
136024-187	11D
136014-188	11C
136014-189	8M
136014-190	5K
136014-191	4L
136014-192	12H

Modifying the Namco PCB Set

Modifications to the Namco PCB set include replacing and adding integrated circuits and sockets to both the CPU PCB and the Video PCB. Be sure to observe the precautions given previously under "Soldering Precautions."

On the CPU PCB:

1. Using the method shown in Figure 9, remove the integrated circuits at locations 4M, 8M, 4L, 8L, 5H, 6H, 5A, and 6A from their sockets.

NOTE

The more recently produced Pole Position boards were manufactured to accommodate the parts in this enhancement kit. Therefore, your game CPU PCB may already have IC sockets at locations 3L, 3M, and 7L. If so, omit steps 2 and 3 and continue with step 4.

2. Using the proper soldering techniques, remove the solder from the plated-through holes at locations 3M, 3L, and 7L.
3. Remove three 28-contact IC sockets from the enhancement kit and install them on the PCB at locations 3M, 3L, and 4L. Be sure to observe the proper placement of the socket index as shown on the PCB.
4. Using the information given in Table 7, remove each specified IC from the enhancement kit and install it in the proper socket.

Table 7 Namco CPU PCB Component Locations

IC Part No.	CPU PCB Location
136014-176	8M
136014-177	8L
136014-178	4M
136014-179	4L
136014-180	6H
136014-181	6A
136014-182	5A
136014-183	5H
136014-184	3M
136014-185	3L
137351-001	7L



On the Video PCB:

1. Using the method shown in Figure 9, remove the integrated circuits at locations 1E, 1F, 4M, 3M, 1M, 4N, 3N, and 1N from their sockets.
2. Using the method given under "Removing Integrated Circuits," remove the soldered-in IC at locations 3C, 4D, 2H, 10L, 9L, 8L, 6M, and 2N.
3. Remove the 24-contact IC sockets from the PCB at locations 1E and 1F.
4. Using the information given in Table 8, remove the appropriate IC sockets from the enhancement kit and install each in the specified location.

Table 8 IC Socket Locations on the Namco Video PCB

No. of Contacts	Install at Location:
16	2H
16	8L
16	9L
16	10L
16	4D
18	6M
18	8C
28	1E
28	1F
28	2M
28	2N

5. Using information given in Table 9, remove each specified IC from the enhancement kit and install it in the proper socket.

Table 9 Namco Video PCB Component Locations

IC Part No.	Video PCB Locations
136014-166	4N
136014-167	4M
136014-168	3N
136014-169	3M
136014-170	1N
136014-171	1M
136014-172	1F
136014-173	1E
136014-174	2M
136014-175	2N
136014-186	8L
136014-187	9L
136014-188	10L
136014-189	2H
136014-190	4D
136014-191	3C
136014-192	6M

SET THE OPTION SWITCHES

NOTE

The manufacturer tested Pole Position II upright games and found that in an arcade environment, upright games have excellent earnings with switches set to sit-down game settings.

If you have an Atari PCB, the switch which controls game play options is located at 9L. (It is located at 9E if you have Namco PCBs.) We recommend that the game be set for 120 seconds preliminary game time, that the preliminary rank and extended rank levels are set to "B" (moderate difficulty), that the game is set for 5 laps per game, and that the game is played at high speed. To select these options, set the toggle switches as listed in Table 10.

If you have an Atari PCB, the switch which controls game price options and special play options is located at 9J. (It is located at 7E if you have Namco PCBs.) We recommend that the game be set for 50 cents per game, that the unit of speed is miles per hour, that the sound is on in the attract mode, and that the screen displays normal action (not frozen!) To select these options, set the toggle switches as listed in Table 11.

Please refer to CO-218-12 for more information about game options.

Table 10 Factory-Recommended Switch Settings for Play Options

	Toggle Switches at 9L or 9E							
Cabinet	1	2	3	4	5	6	7	8
Sit-Down	On	Off	Off	Off	Off	Off	On	On
Upright	Off	Off	Off	Off	Off	Off	Off	On

Table 11 Factory-Recommended Switch Settings for Price and Play Options

	Toggle Switches at 9J or 7E							
Cabinet	1	2	3	4	5	6	7	8
Sit-Down	On	On	Off	On	Off	On	Off	Off
Upright	Off	Off	Off	Off	Off	On	Off	Off

INSTALL THE PRINTED-CIRCUIT BOARDS

## NOTE

Two labels are included with your kit. After you have finished modifying the printed-circuit boards, peel each Pole Position II label off its protective backing and place it by the cable connector of each PCB as shown in Figure 3 or 4.

1. Make sure the foam pad is secure between the Printed-circuit boards of the game set. Carefully slide the modified PCB set into the mounting guides.
2. Connect the edge-connectors to the game printed-circuit boards. Make sure these are firm connections. If your game has an EMI Shield PCB:
  - a. Push the eight snap-in fasteners on the EMI Shield PCB to the locked position.
  - b. Connect the two edge-connectors to the EMI Shield PCB.
3. Close the access panel at the rear of the game.

INSTALL THE DECALS

## CAUTION

The following decal installation procedure should be performed by two people. (One person may have difficulty handling the cabinet and the large decals.)

Three decals on the upright cabinet need to be attached--the left side panel decal, the right side panel decal, and the instrument panel decal (see Figure 1).

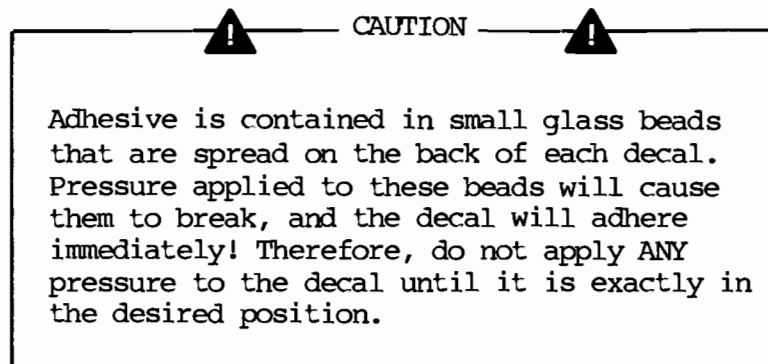

1. Mix a normal dishwashing solution of water and any liquid dishwashing detergent in a shallow pan.
2. GENTLY lay the cabinet on its left side on a soft blanket.
3. Thoroughly clean the side of the game cabinet to ensure the removal of all dust.
4. Use a sponge to liberally apply the water and detergent solution over the entire side of the game cabinet.
5. Carefully place the right side panel decal, sticky side down, in the center of the wet surface of the game cabinet. Position the decal within 1/4-inch of the edges of the right side panel. Handle only the edges of the decal, and do not press any part of the decal. Use masking tape to position the edges of the decal exactly where they should be.
6. Use a squeegee to remove all the excess water and detergent from beneath it by quickly working from the center to the outside edges.
7. When the wrinkles are removed and the decal is free of all excess water and detergent solution, carefully upright the cabinet. Then GENTLY lay the cabinet on its other side on a soft blanket.
8. Repeat steps 2 through 7 for the remaining left side decal.
9. Carefully upright the cabinet. GENTLY place the instrument panel decal directly over the instrument panel.
10. Press the decal firmly and smoothly from the center to the outside edges of the decal.
11. Use a lint-free cloth to wipe off any excess water and detergent from inside and outside of the cabinet. Allow time to dry before proceeding.

INSTALL THE SELF-TEST CHART

1. Open the access panel at the rear of the game.
2. Remove and discard the self-test chart that is in place.
3. Staple the Pole Position II Self-Test Chart, ST-255, into place.  
(This chart contains important information about game settings.)
4. Close the access panel at the rear of the game.

PERFORM A SELF-TEST

## NOTE

Perform the self-test after the enhancement modifications are completed!

1. Plug the game in.
2. Set the power on/off switch to the on position.
3. Perform the self-test procedure as described in CO-218-12 (Pole Position II Operator Information).

CHANGE THE POLE POSITION SCHEMATIC PACKAGE

The Pole Position Schematic Package Supplement, SP-218, supports games with the Atari PCB set. The Pole Position Schematic Package Supplement, SP-219, supports games with the Namco PCB set. Refer to CO-218-12 (Pole Position II Operator Information) for changes to these schematic packages. Mark these changes into your schematic package!

After you have changed the schematic package, the enhancement procedure for the Upright cabinet is complete.

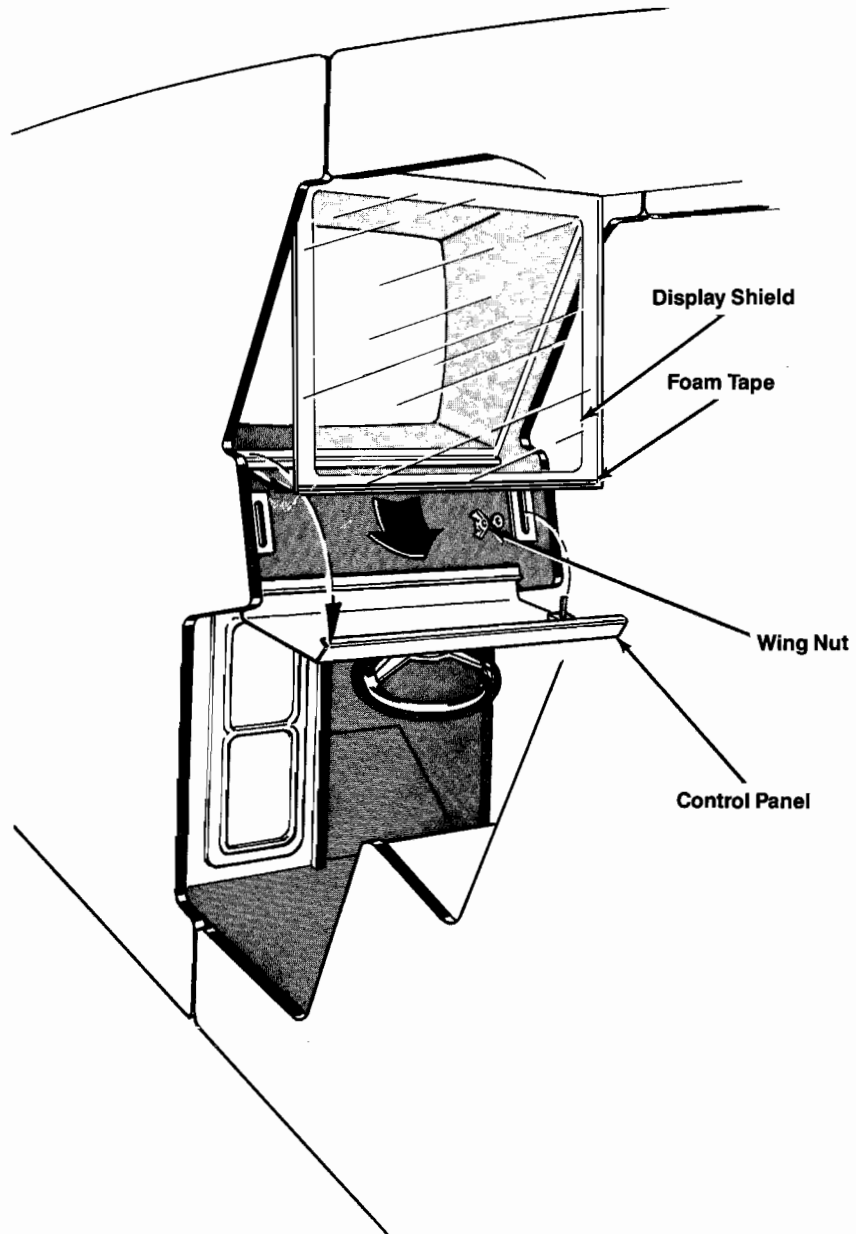

**Figure 10 Display Shield Replacement—Sit-Down**

ENHANCEMENT PROCEDURE FOR THE SIT-DOWN GAME

WARNING



These procedures must be performed by qualified service personnel. UNPLUG THE GAME before starting the following procedures.

REPLACE THE DISPLAY SHIELD

This procedure is illustrated in Figure 10.



CAUTION



Have someone hold the control panel firmly against the cabinet while you are removing the wing nuts from the rear of the game. This prevents the top-heavy assembly from crashing against the cabinet.

1. Open the access panel at the rear of the game.
2. Reach toward the front of the game, and remove the wing nuts and washers that secure the control panel to the game cabinet. (Someone should hold the control panel against the cabinet as you do this!) Save this hardware for reassembly later.
3. Pull the bottom of the display shield toward you. Remove and discard this shield.
4. Apply a strip of foam tape to the front bottom of the display shield provided in the enhancement kit.
5. Insert the Pole Position II display shield. Close the control panel. Someone should hold the control panel against the cabinet as you reinstall the hardware.
6. From behind the cabinet, reinstall the wing nuts and washers you saved in step 1.



REMOVE THE PRINTED-CIRCUIT BOARDS

See TM-218, Figure 1-2, for the location of the game printed-circuit boards in the sit-down cabinet.

## NOTE

If your game was built in the United States of America, the CPU and Video printed-circuit boards are attached to an Electromagnetic Interference (EMI) Shield printed-circuit board. If your game was built in Ireland, it will not have the EMI Shield printed-circuit board.

1. Open the door at the rear of the game. The printed-circuit boards are mounted on the door.
2. Disconnect the two edge-connectors from the game PCB set. If your game has an EMI Shield PCB:
  - a. Disconnect the two edge-connectors from the EMI Shield PCB.
  - b. Pull the eight snap-in fasteners on the EMI Shield PCB to the unlocked position.

## CAUTION

Be careful not to twist the Printed-Circuit Boards as you remove them! If you do, components or connections may be loosened.

3. Carefully slide the PCB set straight out of the guides.

MODIFY THE GAME PCB

This procedure is the same as the procedure for the upright cabinet.

SET THE OPTION SWITCHES

After your PCB set has been modified, refer to "Set the Option Switches" on page 22 of this manual for information on setting the option switches.

INSTALL THE PRINTED-CIRCUIT BOARDS

## NOTE

Two labels are included with your kit. After you have finished modifying the printed-circuit boards, peel each Pole Position II label off its protective backing and place it by the cable connector of each PCB as shown in Figure 3 or 4.

1. Make sure the foam pad is secure between the printed-circuit boards of the game set. Carefully slide the modified PCB set into the mounting guides.
2. Connect the edge-connectors to the game printed-circuit boards. Make sure these are firm connections. If your game has an EMI Shield PCB:
  - a. Push the eight snap-in fasteners on the EMI Shield PCB to the locked position.
  - b. Connect the two edge-connectors to the EMI Shield PCB.
3. Close the door at the rear of the game.

## Install the Decals



## CAUTION



The following decal installation procedure should be performed by two people. One person may have difficulty handling the cabinet and the large decals.

Seven decals on the sit-down cabinet need to be replaced—two left side panel decals, two right side panel decals, two control panel decals, and the front panel decal (see Figure 1).

 CAUTION 

Adhesive is contained in small glass beads which are spread on the back of each decal. Pressure applied to these beads will cause them to break, and the decal will adhere immediately! Therefore, do not apply ANY pressure to the decal until it is exactly in the desired position.

1. Mix a normal dishwashing solution of water and any liquid dishwashing detergent in a shallow pan.
2. GENTLY lay the cabinet on its right side on a soft blanket.
3. Thoroughly clean the side of the game cabinet to ensure the removal of all dust.
4. Use a sponge to liberally apply the water and detergent solution over the entire side of the game cabinet.
5. Carefully place the rear left side panel decal, sticky side down, in the center of the wet surface of the game cabinet. Position the decal within 1/4-inch of the edges. Handle only the edges of the decal, and do not press any part of the decal. Use masking tape to position the edges of the decal exactly where they should be.
6. Use a squeegee to remove all the excess water and detergent from beneath it by quickly working from the center to the outside edges.
7. Carefully place the front left side panel decal, sticky side down, in the center of the wet surface of the game cabinet. Position the decal within 1/4-inch of the edges. Handle only the edges of the decal, and do not press any part of the decal. Use masking tape to position the edges of the decal exactly where they should be.
8. When the wrinkles are removed and the decal is free of all excess water and detergent solution, carefully upright the cabinet. Then GENTLY lay the cabinet on its other side on a soft blanket.
9. Repeat steps 2 through 8 for the decals that belong on the right side panels.
10. Carefully upright the cabinet.

11. Use masking tape to position the edges of the front panel decal to within 1/4-inch of the edges of the front panel.
12. Use a squeegee to press the decal firmly and smoothly from the center to the outside edges of the decal.
13. GENTLY position the decal that has instructions for Pole Position II over the existing instructions on the control panel. Press the decal firmly and smoothly from the center to the outside edges of the decal.
14. Place the bonus points decal between the steering wheel and the shifter. Press the decal firmly and smoothly from the center to the outside edges of the decal.
15. Use a lint-free cloth to wipe off any excess water and detergent from inside and outside of the cabinet. Allow time to dry before proceeding.

INSTALL THE SELF-TEST CHART

1. Open the door at the rear of the game.
2. Remove and discard the self-test chart that is in place.
3. Staple the Pole Position II Self-Test Chart, ST-255, into place.  
(This chart contains important information about game settings.)
4. Close the rear door.

PERFORM A SELF-TEST

## NOTE

It is important to perform the self-test after the enhancement modifications are completed!

1. Plug the game in.
2. Set the power on/off switch to the on position.
3. Perform the self-test procedure as described in CO-218-12 (Pole Position II Operator Information).

CHANGE THE POLE POSITION SCHEMATIC PACKAGE

The Pole Position Schematic Package Supplement, SP-218, supports games with the Atari printed-circuit boards. The Pole Position Schematic Package Supplement, SP-219, supports games with the Namco printed-circuit boards. Refer to CO-218-12 (Pole Position II Operator Information) for changes to these schematic packages. Mark these changes into your schematic package!

After you have changed the schematic package, the enhancement procedure for the sit-down cabinet is complete.



ATARI, INC.  
790 SYCAMORE DRIVE  
P.O. BOX 906  
MILPITAS, CALIFORNIA 95035  
408/942-3100 • TELEX 35-7488