

54-7393-01

THIS INFORMATION IS UP TO DATE AS OF NOVEMBER, 1982

---

# **SERVICE AND OPERATION MANUAL**

## **G08-105 X-Y COLOUR MONITOR**

---

ELECTROHOME ELECTRONICS  
A DIVISION OF ELECTROHOME LIMITED, KITCHENER, ONTARIO, CANADA N2G 4J6

# TABLE OF CONTENTS

Description	Page
G08-105 Model . . . . .	1
Service Data Reference . . . . .	2
Warnings . . . . .	2
Operating Instructions . . . . .	3
Performance and Operating Data . . . . .	3
Product Safety and Guidelines . . . . .	4
Service Set-Up Procedure . . . . .	5-7
CRT P.C.B. Component Layout . . . . .	8
EHT P.C.B. Component Layout . . . . .	8
X-Y P.C.B. Component Layout . . . . .	9
Notes . . . . .	10
Schematic . . . . .	11

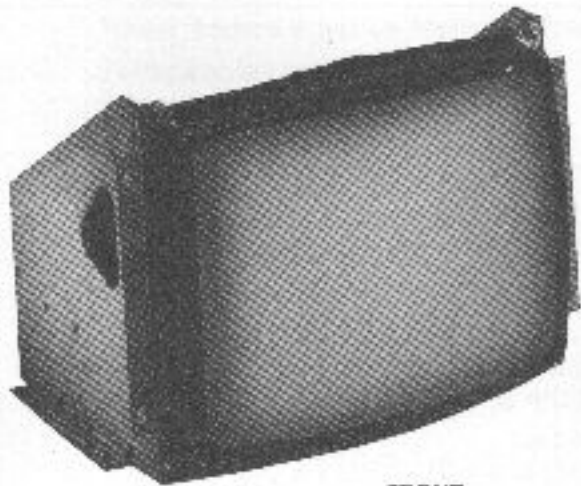

FRONT

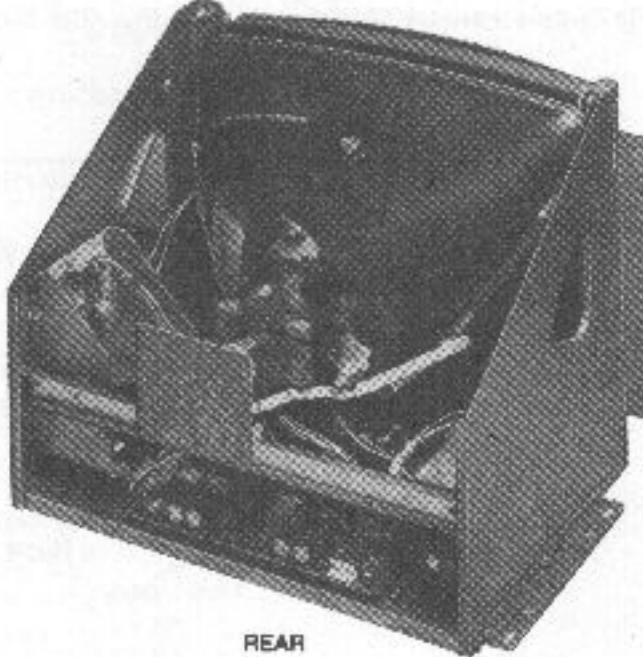

REAR

G08-105

NOTES

## Warnings

### 1. Power Up Warning

Caution: If the monitor is to be powered up outside of the games console, an isolation transformer providing the correct AC voltages must be used for the AC power source.

### 2. X-Radiation

This chassis has been designed for minimal x-radiation hazard. However, to avoid possible exposure to soft x-radiation it is IMPERATIVE that the EHT circuitry IS NOT modified.

### 3. High Voltage

The colour monitor contains HIGH VOLTAGES derived from power supplies capable of delivering LETHAL quantities of energy. To avoid DANGER TO LIFE, do not attempt to service the chassis until all precautions necessary for working on HIGH VOLTAGE equipment have been observed.

### 4. CRT Handling

The picture tube encloses a high vacuum and due to the large surface area is subject to extreme force. Care must be taken not to bump or scratch the picture tube as this may cause the tube to implode resulting in personal injury and property damage. Shatter-proof goggles must be worn by individuals while handling the CRT or installing it in the monitor. Do not handle the CRT by the neck.

### 5. To prevent fire or shock hazard DO NOT EXPOSE THIS MONITOR TO RAIN OR MOISTURE.

**test point 1 (See Fig. 1)**

under all condition.

+52VDC

+70VDC

**Frequency**

50 Hz

60 Hz

**2.0 High Voltage (EHT)**

For 19" V Models

21.0 K

22 K

NOTE: Condition Above  
I (Beam) = 0**3.0 Pin Assignment for P100**

Pin No.	Description	Impedance	Signal Level
1	H. Input (X)	2K	± 4V
2	V. Input (Y)	2K	± 3V
3	GND		
4	Red Input	2K7	0-+4V
5	Green Input	2K7	0-+4V
6	Blue Input	2K7	0-+4V

**4.0 Service Set Up Control**

NOTE: These controls have been factory adjusted. If adjustment is necessary check set up procedure in this manual.

**4.1 G2 Adjustment**

R930

**4.2 Vert. Cent.**

R605

**4.3 Hori. Cent.**

R712

**4.4 Height**

R611

**4.5 Width**

R702

**4.6 Crt. Cut Off Control (See Fig. 3)**

Red Cutoff

R107

Green Cutoff

R118

Blue Cutoff

R136

**4.7 Video Drive Control (See Fig. 3)**

Red Drive

R106

Green Drive

R117

**4.8 EHT Duty Cycle**

R918

**4.9 EHT Frequency Adj.**

R917

**4.10 EHT Sensing Control**

R933

**4.11 EHT Regulator Adjustment**

R945

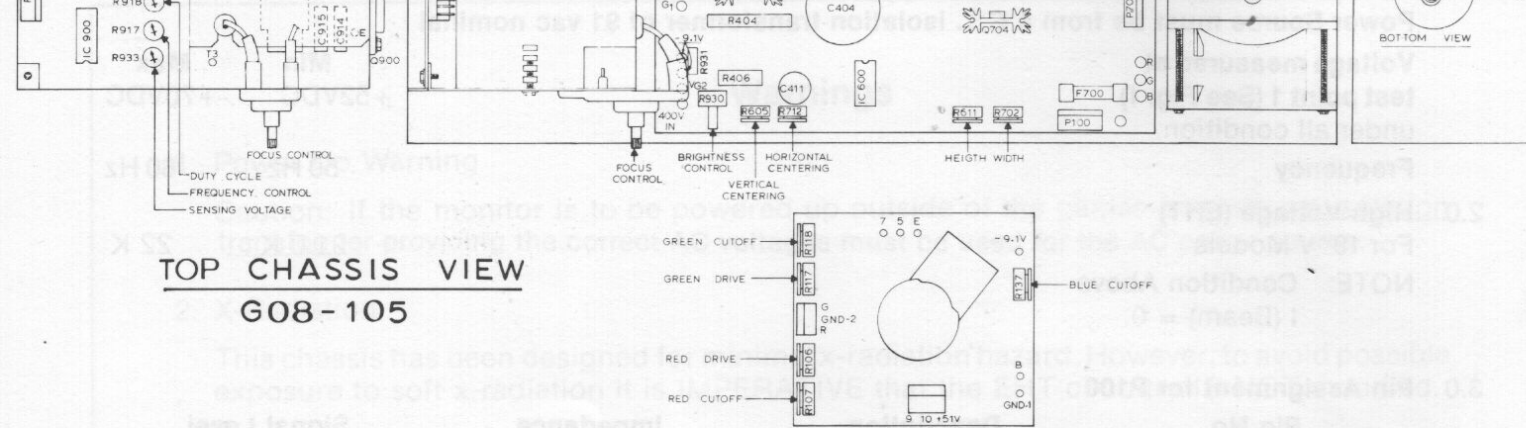

**TOP CHASSIS VIEW**  
**G08-105**

Figure 1

## Product Safety and Servicing Guidelines

### Safety Checks

Subject: Fire and Shock Hazard

1. No modification of any circuit should be attempted. Service work should be performed only after you are thoroughly familiar with all of the following safety checks and service guidelines. To do otherwise increases the risk of potential hazards and injury to the user.
2. When service is required, observe the original lead dress. Extra precaution should be given to assure correct lead dress in the high voltage circuitry area. Where a short circuit has occurred, replace those components that indicate evidence of overheating. Always use the manufacturer's specified replacement component. See parts list in the back of this manual.
3. Periodically check the high voltage for proper value using a meter of known accuracy and calibration.
4. Check for frayed insulation on wires.

Set up should be done in a north/south direction. Horizontal and vertical centering taps should be set to the centre position if a major component has been changed.

## 1.0 Purity

- 1.1 Loosen yoke clamp screw and positioning screw. Remove adhesive material from positioning screw. (Figure 2).
- 1.2 A small quantity of "nail polish" has been used to lock the purity convergence rings in place. This seal must be broken with a sharp tipped instrument before any adjustments are attempted. It goes without saying that upon completion of all adjustments, a dab of paint or nail polish must be re-applied to edge of rings to prevent movement.
- 1.3 Connect an appropriate signal source, eg: Electro-home X-Y generator producing a white field plus individual red, green and blue fields.
- 1.4 Move the tabs of each of the ring magnets: (purity magnets, 4 pole convergence magnets and 6 pole convergence) together as shown in figure 3. (See figure 2 for location of ring magnets).
- 1.5 Turn off the red and blue fields on the generator and adjust the G2 control (figure 1) to produce a green field.
- 1.6 Pull the deflection yoke back so that a green band appears in the centre of the screen.
- 1.7 Spread the tabs of the purity magnets apart as little as necessary and rotate both rings together to center the green band horizontally on the face of the CRT (See Fig. 4).
- 1.8 Slide the yoke towards the bell of the picture tube slowly to obtain a uniform green field (pure in color) across the entire tube face. Juggle back and forth slightly as necessary. Lightly tighten yoke retaining clamp.
- 1.9 Momentarily switch on a cross-hatch signal and rotate yoke to level the pattern on the face of CRT.
- 1.10 Return generator to regain green raster.
- 1.11 Turn off green field and check for pure field for each of the red and blue fields. Reposition yoke if necessary to obtain optimum purity on all fields.
- 1.12 Tighten yoke clamp screw to prevent yoke shift or rotation. (Do not tighten positioning screws at this time.)

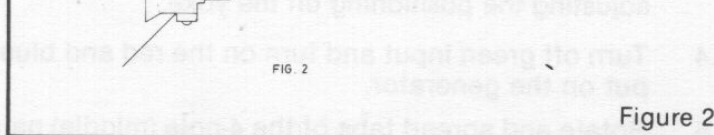

Figure 2

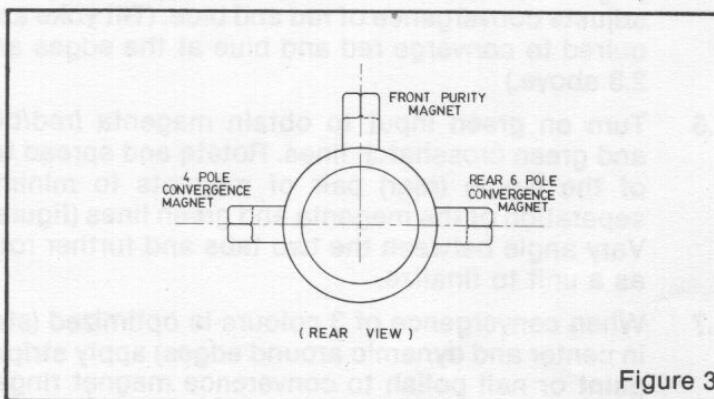

Figure 3

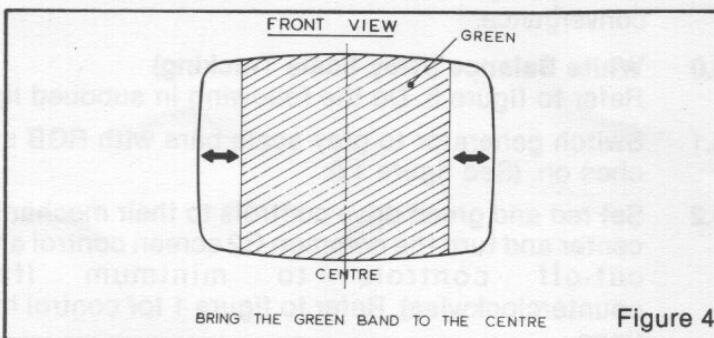

Figure 4

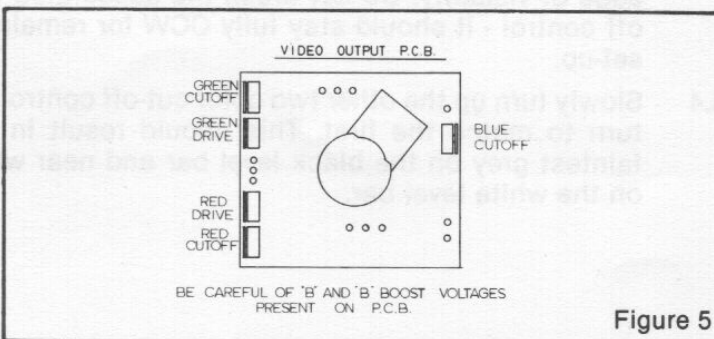

Figure 5

2.4 Turn off green input and turn on the red and blue input on the generator.

2.5 Rotate and spread tabs of the 4-pole (middle) pair of magnets to minimize separation of the red and blue crosshatch lines around the center of the screen (Figure 6). Variation of the angle between the tabs adjusts convergence of red and blue. (Tilt yoke as required to converge red and blue at the edges as in 2.3 above.)

2.6 Turn on green input to obtain magenta (red/blue) and green crosshatch lines. Rotate and spread tabs of the 6-pole (rear) pair of magnets to minimize separation of the magenta and green lines (figure 7). Vary angle between the two tabs and further rotate as a unit to finalize.

2.7 When convergence of 3 colours is optimized (static in center and dynamic around edges) apply stripe of paint or nail polish to convergence magnet rings to prevent movement.

2.8 Tilt yoke, by adjusting positioning screw, in up-down and left-right direction for best circumference convergence.

### 3.0 White Balance (Grey Scale Tracking)

Refer to figure 5. Do the following in subdued light:

3.1 Switch generator to grey scale bars with RGB switches on. (See figure 12).

3.2 Set red and green drive controls to their mechanical center and turn the common G2 screen control and 3 cut-off controls to minimum (fully counterclockwise). Refer to figure 1 for control locations.

3.3 Slowly turn up G2 screen control until the first faint color appears at black level bar, then back off to edge of visibility. Do not touch the associated cut-off control - it should stay fully CCW for remaining set-up.

3.4 Slowly turn up the other two color cut-off controls in turn to match the first. This should result in the faintest grey on the black level bar and near white on the white level bar.



Let the green and magenta lines come in line by turning two 6-pole magnets.

Figure 7

REAR VIEW

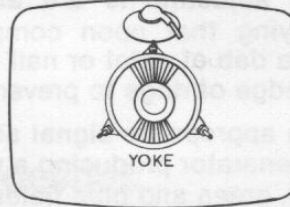

ROUGHLY ADJUST THE CIRCUMFERENTIAL CONVERGENCE AND ADJUST POSITIONING SCREW

Figure 8

[FRONT VIEW]

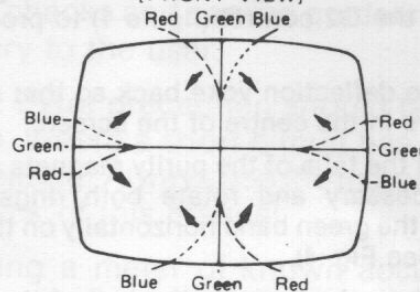

Tilting the yoke upward will move the lines as shown with the arrows.

Figure 9

[FRONT VIEW]

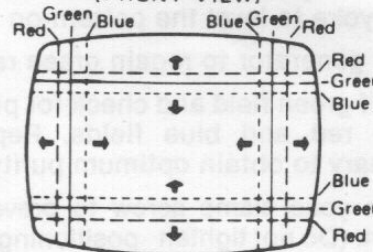

Tilting the yoke to the right will move the lines as shown with the arrows.

Figure 10



horizontal size and centering controls (4 controls).

- 4.2 Switch generator to the cross hatch pattern.
- 4.3 Adjust the centering controls so that the center lines cross at the exact center of the CRT.
- 4.4 Adjust the size controls so that the cross hatch pattern measures 10.5" vertically and 14.5" horizontally.

#### 5.0 Focus

Adjust focus control for best overall definition and picture detail on an average signal applied. (Highlights should be favoured.)

#### 6.0 E.H.T. Alignment

- 6.1 After 10 minutes warm up, adjust voltage regulator for 100V, -6V + 2V via R945. Measurement is made between anode of D902 and ground.
- 6.2 Jumper TP1 to ground with jumpers hook up oscilloscope to collector of Q902 and adjust R918 for duty cycle of  $\cong 20$  usec on  $\cong 35$  usec OFF.
- 6.3 Adjust R917 for anode voltage of  $21 \pm 300V$  then remove jumper at TP1 and adjust R933 for  $OV \pm 15 MV$  at TP1.  
NOTE: Adjustment made with zero beam current.

#### 7.0 X-Y Color Service Generator for G08 Monitor

Electrohome has developed a X-Y color service generator that is specifically designed for use with the G08 color X-Y monitor. It provides the monitor with the correct X, Y and video signals for 3 patterns.

- 1) Fine cross-hatch pattern.
- 2) Grey scale bars
- 3) Complete field

Three color selection switches, red, green and blue, provide the ability to display the above patterns in the three primary colors as well as the three secondary colors.

This product may be ordered from:

ELECTROHOME (U.S.A.) LIMITED  
250 Wales Avenue  
TONAWANDA, New York 14150  
Telephone: (716) 694-3332

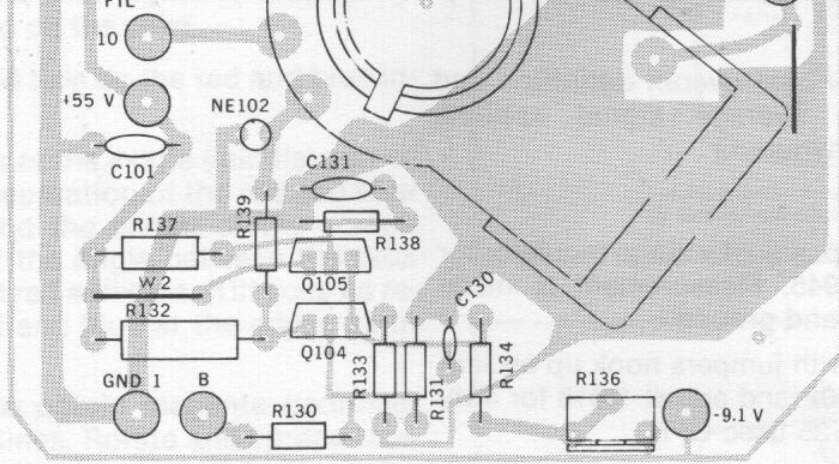

### EHT P.C.B. COMPONENT LAYOUT

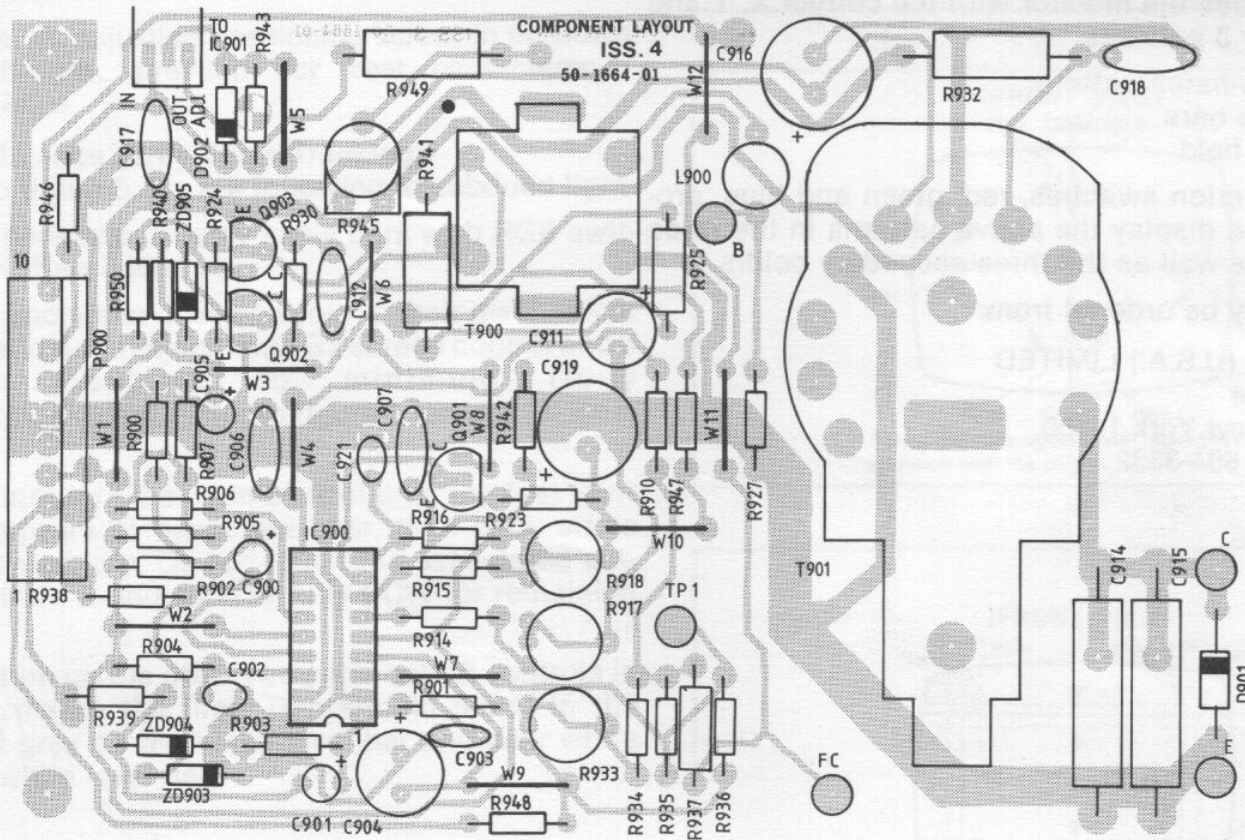

# X-Y P.C.B. COMPONENT LAYOUT

10-2887-02 MRETTAV J101

## COMPONENT LAYOUT

ISS. 4

50-1665-01

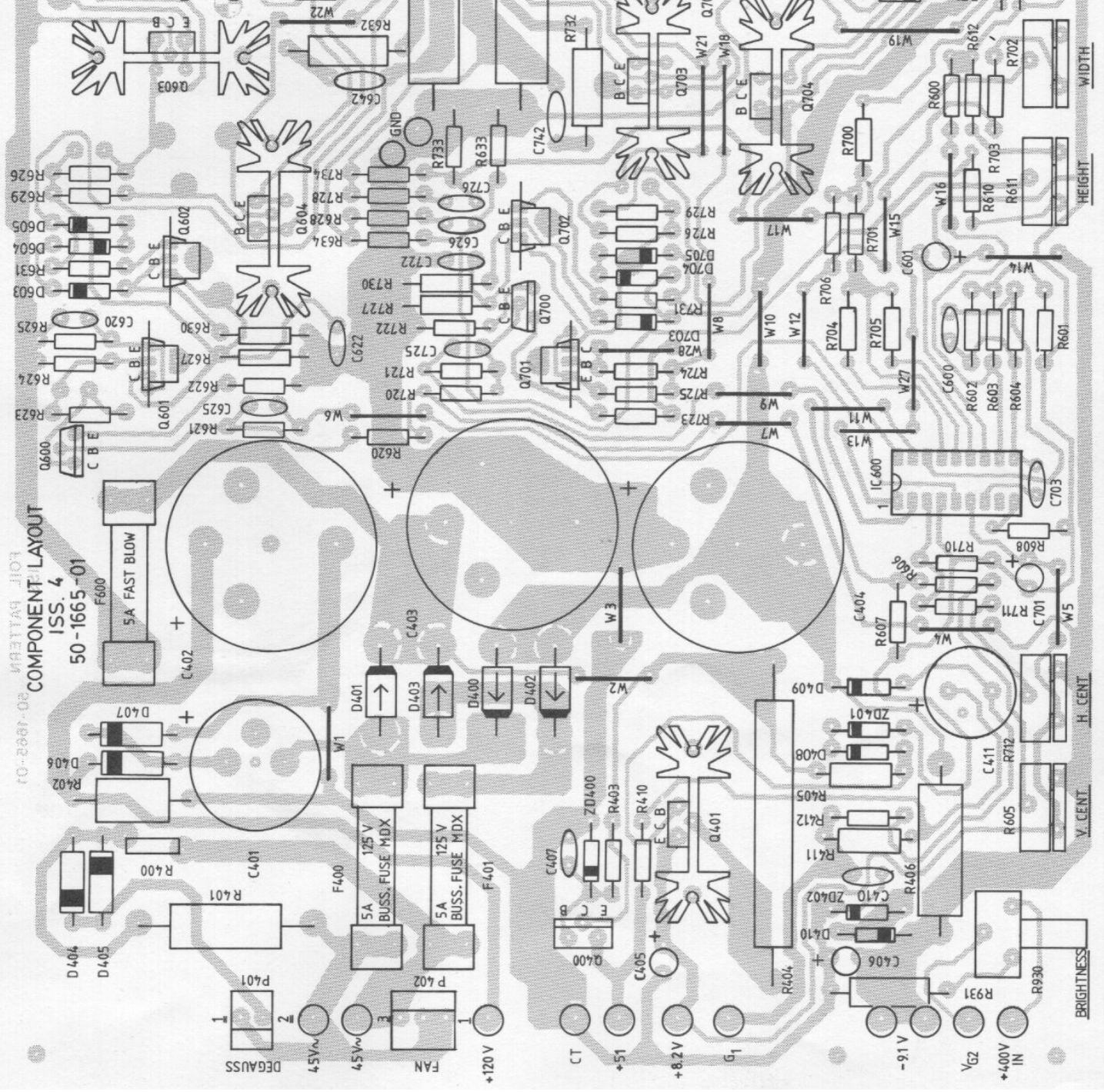

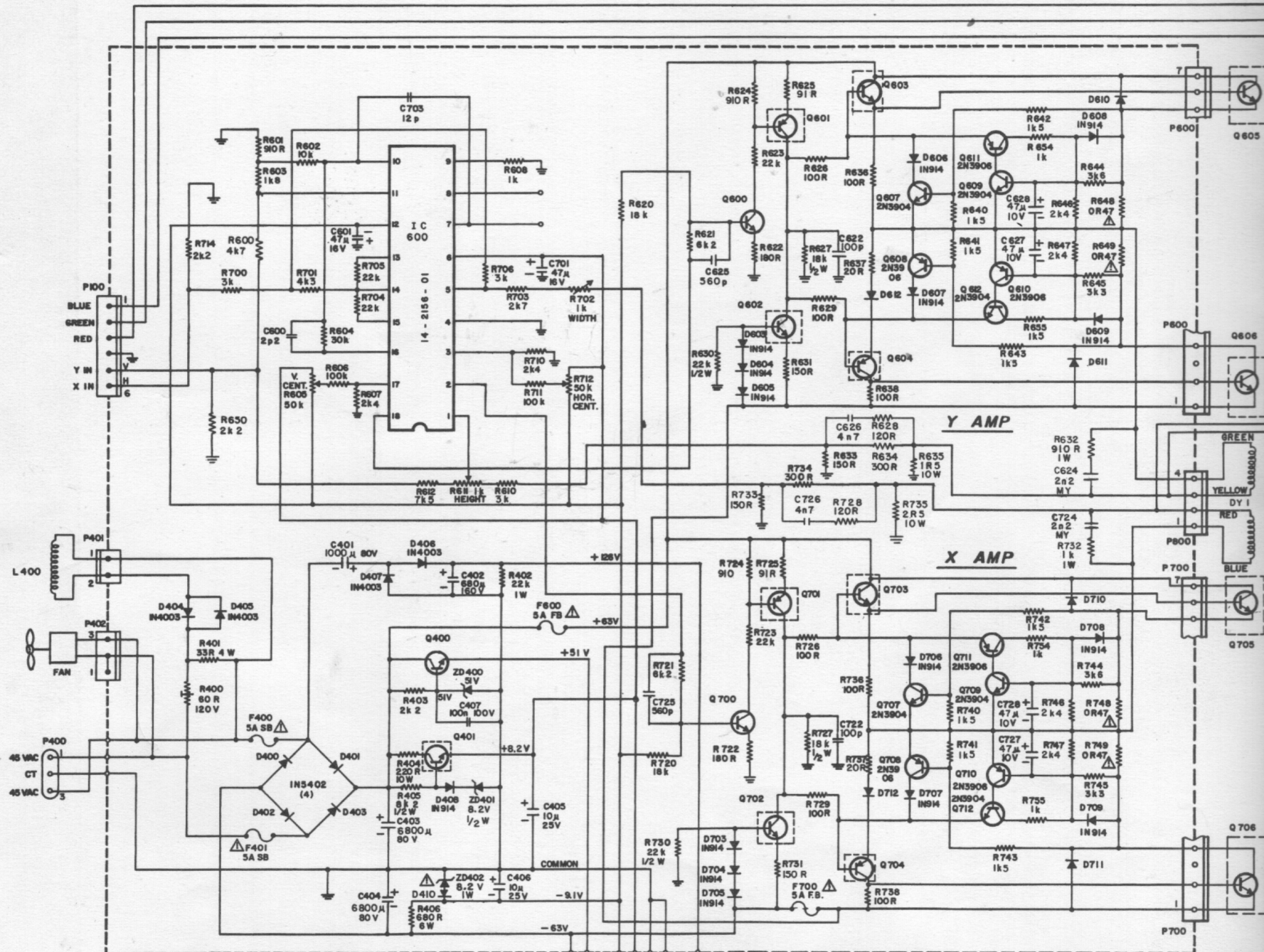

**NOTES.**

RESISTANCE - RESISTANCE IN OHMS (R) K (KILOHMS), OR M (MEG OHMS)  
1/4 WATT, 5% TOLERANCE UNLESS OTHERWISE NOTED.

CAPACITORS - CAPACITY IN P (PICOFARADS) N (NANOFARADS), OR  
μ (MICROFARADS) D.C.V.V. AND TOLERANCE NOTED WHERE CRITICAL.

FOR SAFETY PURPOSES (AND CONTINUING RELIABILITY)  
REPLACE ALL COMPONENTS MARKED WITH SAFETY SYMBOL  WITH IDENTICAL TYPE.

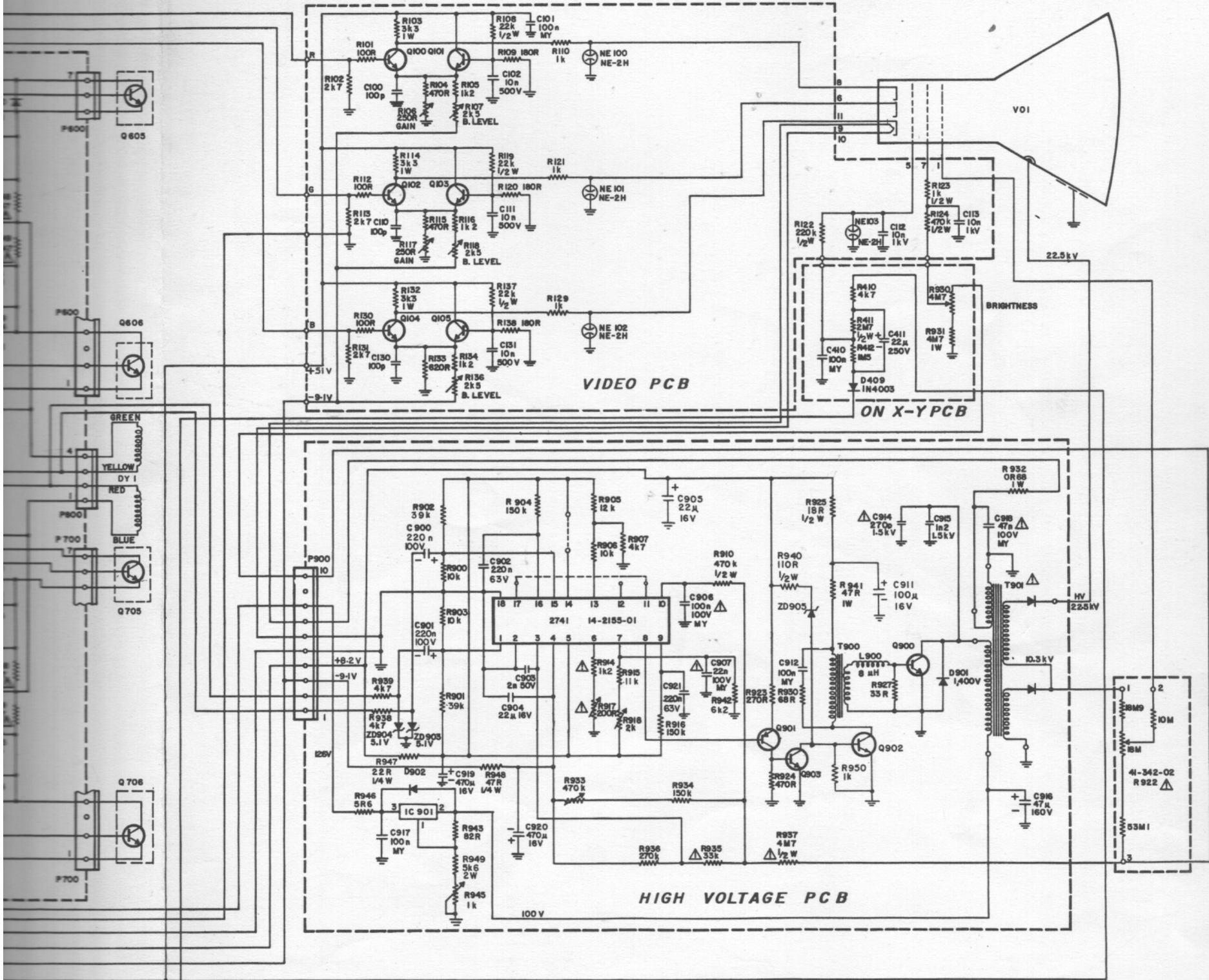

# VIDEO DISPLAY MARKETING

ELECTROHOME ELECTRONICS

54-7393-01

THIS INFORMATION IS UP TO DATE AS OF JANUARY 1983.

---

## SERVICE DATA

## G08-105X-Y COLOR MONITOR

FILE WITH  
G08-105X-Y SERVICE MANUAL

---

ELECTROHOME ELECTRONICS  
ELECTROHOME Limited  
KITCHENER, ONTARIO, CANADA N2G 4J8

**RESISTORS (cont'd)**

Symbol	Description	Electrohome Part Number
R733	150R .25W 5%	40-121515-31
R734	300R .25W 5%	40-123015-31
R735	2R5 10W 10%	42-142571-06
R736	100R .25W 5%	42-000063-66
R737	20R .25W 5%	40-122005-31
R738	100R .25W 5%	42-000063-66
R740	1K5 .25W 5%	40-121525-31
R741	1K5 .25W 5%	40-121525-31
R742	1K5 .25W 5%	40-121525-31
R743	1K5 .25W 5%	40-121525-31
R744	3K6 .25W 5%	40-123625-31
R745	3K3 .25W 5%	40-122425-31
R746	2K4 .25W 5%	40-122425-31
R747	2K4 .25W 5%	42-000063-68
R748	.47R 2W	42-000063-68
R749	.47R 2W	40-121025-31
R754	1K .25W 5%	40-121025-31
R755	1K .25W 5%	41-000299-32
R930	4R7 Trimpot	40-424751-01
R931	4M7 1W 10%	

**FUSES**

Symbol	Description	Electrohome Part Number
F400	5A 125V Slow Blow	27-000005-35
F401	5A 125V Slow Blow	27-000005-35
F600	5A 250V Fast Blow	27-000014-20
F700	5A 250V Fast Blow	27-000014-20

**CRT SOCKET PCB ASS'Y 03-170033-01  
SEMICONDUCTORS**

Symbol	Description	Electrohome Part Number
Q100	Transistor 2N6567	14-000972-12
Q101	Transistor 2N6567	14-000972-12
Q102	Transistor 2N6567	14-000972-12
Q103	Transistor 2N6567	14-000972-12
Q104	Transistor 2N6567	14-000972-12
Q105	Transistor 2N6567	14-000972-12

**LAMPS**

Symbol	Description	Electrohome Part Number
NE100	Lamp	27-000011-10
NE101	Lamp	27-000011-10
NE102	Lamp	27-000011-10
NE103	Lamp	27-000011-10

**CAPACITORS**

Symbol	Description	Electrohome Part Number
C100	Capacitor 100pF	46-610135-04
C101	Capacitor 100NF 200V	46-171042-02
C102	Capacitor 10NF 500V 10%	46-310317-07
C110	Capacitor 100pF	46-610135-04
C111	Capacitor 10NF 500V 10%	46-310317-07
C112	Capacitor 10NF 1KV	46-510311-36
C113	Capacitor 10NF 1KV	46-510311-36
C130	Capacitor 100pF	46-610135-04
C313	Capacitor 10NF 500V 10%	46-310317-07

**RESISTORS**

Symbol	Description	Electrohome Part Number
R101	100R .25W 5%	40-121015-31
R102	2K7 .25W 5%	40-122725-31
R103	3K3 1W 5%	40-423325-17
R104	470R .25W 5%	40-124715-31
R105	1K2 .25W 5%	40-121225-31
R106	250R Trimpot	41-000299-25
R107	2K5 Trimpot	41-000299-26
R108	22K .5W 5%	40-222235-31
R109	180R .25W 5%	40-121815-31
R110	1K .25W 5%	40-121025-31
R112	100R .25W 5%	40-121015-31
R113	2K7 .25W 5%	40-122725-31
R114	3K3 1W 5%	40-423325-17
R115	470R .25W 5%	40-124715-31
R116	1K2 .25W 5%	40-121225-31
R117	250R Trimpot	41-000299-25
R118	2K5 Trimpot	41-000299-26
R119	22K .5W 5%	40-222235-31
R120	180R .25W 5%	40-121815-31
R121	1K .25W 5%	40-121025-31
R122	220K .5W 5%	40-222245-31
R123	1K .5W 5%	40-221025-31
R124	470K .5W 5%	40-224745-31
R130	100R .25W 5%	40-121015-31
R131	2K7 .25W 5%	40-122725-31
R132	3K3 1W 5%	40-423325-31
R133	620R .25W 5%	40-126215-31

## CAPACITORS (cont'd)

Symbol	Description	Electrohome Part Number
C703	Capacitor 12pF 500V 10%	86-312013-01
C722	Capacitor 100pF 500V	86-310113-01
C725	Capacitor 500pF 500V	86-356127-01
C726	Capacitor 4N7 100V 10%	88-174721-02
C727	Capacitor 47uF 10V	84-447002-01
C728	Capacitor 47uF 10V	84-447002-01
C742	Capacitor 2N2 200V	48-172222-02

## RESISTORS

Symbol	Description	Electrohome Part Number
R400	60R 120V Thermistor	42-000060-01
R401	33R 4W 10% WW	42-113301-03
R402	22K 1W 10%	40-422231-15
R403	2K2 .25W 5%	40-122225-31
R404	220R 10W	42-142211-06
R405	8K2 .5W 5%	40-226225-31
R406	680R 6W	42-116811-06
R410	4K7 .25W 5%	40-124725-31
R411	2M7 .5W 5%	40-222755-31
R412	1M5 .25W 5%	40-121555-31
R600	4K7 .25W 5%	40-124725-31
R601	910R .25W 5%	40-129115-31
R602	10K .25W 5%	40-121035-31
R603	1K8 .25W 5%	40-121825-31
R604	30K .25W 5%	40-123035-31
R605	50K Trimpot	41-000299-30
R606	100K .25W 5%	40-121045-31
R607	2K4 .25W 5%	40-122425-31
R608	1K .25W 5%	40-121025-31
R610	3K .25W 5%	40-123025-31
R611	1K Trimpot	41-000299-28
R612	7K5 .25W 5%	40-127525-31
R620	18K .25W 5%	40-121835-31
R621	6K2 .25W 5%	40-126225-31
R622	180R .25W 5%	40-121815-31
R623	22K .25W 5%	40-122235-31
R624	910R .25W 5%	40-129115-31
R625	91R .25W 5%	40-129105-31
R626	100R .25W 5%	42-000063-66
R627	18K .5W 5%	40-221835-31
R628	120R .25W 5%	40-121215-31
R629	100R .25W 5%	42-000063-66
R630	22K .5W 5%	40-222235-31
R631	150R .25W 5%	40-121515-31
R632	910R 1W 10%	40-429111-11
R633	150R .25W 5%	40-121515-31
R634	300R .25W 5%	40-123015-31
R635	1R5 10W	42-141571-08
R636	100R .25W 5%	42-000063-66
R637	20R .25W 5%	40-122005-31
R638	100R .25W 5%	42-000063-66
R640	1K5 .25W 5%	40-121525-31
R641	1K5 .25W 5%	40-121525-31
R642	1K5 .25W 5%	40-121525-31
R643	1K5 .25W 5%	40-121525-31
R644	3K6 .25W 5%	40-123625-31
R645	3K3 .25W 5%	40-123325-31
R646	2K4 .25W 5%	40-122425-31
R647	2K4 .25W 5%	40-122425-31
R648	.47R 2W	42-000063-68
R649	.47R 2W	42-000063-68
R654	1K .25W 5%	40-121025-31
R655	1K .25W 5%	40-121025-31
R656	2K2 .25W 5%	40-122225-31
R700	3K .25W 5%	40-123025-31
R701	4K3 .25W 5%	40-124325-31
R702	1K Trimpot	41-000299-28
R703	2K7 .25W 5%	40-122725-31
R704	22K .25W 5%	40-122235-31
R705	22K .25W 5%	40-122235-31
R706	3K .25W 5%	40-123025-31
R710	2K4 .25W 5%	40-122425-31
R712	50K Trimpot	41-000299-30
R714	2K2 .25W 5%	40-122225-31
R720	18K .25W 5%	40-121835-31
R721	6K2 .25W 5%	40-126225-31
R722	180R .25W 5%	40-121815-31
R723	22K .25W 5%	40-122235-31
R724	910R .25W 5%	40-129115-31
R725	91R .25W 5%	40-129105-31
R726	100R .25W 5%	42-000063-66
R727	18K .5W 5%	40-221835-31
R728	120R .25W 5%	40-121215-31
R729	100R .25W 5%	42-000063-66
R730	22K .5W 5%	40-222235-31
R731	150R .25W 5%	40-121515-31
R732	1K 1W 10%	40-421021-11



## E.H.T. SUPPLY ASS'Y KIT 03-170010-01

Symbol	Description	Electrohome Part Number
Q900	PWR Transistor 5A 50W	14-000001-36
R922	Focus Control	41-000342-02

## DEFLECTION AMP PCB ASS'Y 03-170032-01

## SEMICONDUCTORS

Symbol	Description	Electrohome Part Number
IC600	IC Input Amplifier	14-002156-01
D400	Rectifier	28-000022-44
D401	Rectifier	28-000022-44
D402	Rectifier	28-000022-44
D403	Rectifier	28-000022-44
D404	Rectifier 1A 200V	28-000022-28
D405	Rectifier 1A 200V	28-000022-28
D406	Rectifier 1A 200V	28-000022-28
D407	Rectifier 1A 200V	28-000022-28
D408	Diode 1N914	14-000514-42
D409	Rectifier 1A 200V	28-000022-28
D410	Rectifier 1A 200V	28-00022-38
D603	Diode 1N914	14-000514-42
D604	Diode 1N914	14-000514-42
D605	Diode 1N914	14-000514-42
D606	Diode 1N914	14-000514-42
D607	Diode 1N914	14-000514-42
D608	Diode 1N914	14-000514-42
D609	Diode 1N914	14-000514-42
D610	Diode 1P645	14-000514-51
D611	Diode 1P645	14-000514-51
D612	Diode 1P645	14-000514-51
D703	Diode 1N914	14-000514-42
D704	Diode 1N914	14-000514-42
D705	Diode 1N914	14-000514-42
D706	Diode 1N914	14-000514-42
D707	Diode 1N914	14-000514-42
D708	Diode 1N914	14-000514-42
D709	Diode 1N914	14-000514-42
D710	Diode 1P645	14-000514-51
D711	Diode 1P645	14-000514-51
D712	Diode 1P645	14-000514-51
ZD400	Zener Diode 51V 5%	14-000515-09
ZD401	Zener Diode 8.2V 1W	14-1N4738-A X
ZD402	Zener Diode 8.2V 1W	14-1N4738-A X
Q400	Transistor 1A Tip29 B	14-000-966-23
Q401	Transistor 1A Tip29B	14-000966-23
Q600	Transistor 300V 2W 2N6558	14-000951-12
Q601	Transistor PNP 300V .5A	14-000950-12
Q602	Transistor 300V 2W 2N6558	14-000951-12
Q603	Transistor 2N5656	14-000974-13
Q604	Transistor MJE350	14-000975-13
Q607	Transistor	14-2N3904-0L
Q608	Transistor	14-2N3906-0L
Q609	Transistor	14-2N3904-0L
Q610	Transistor	14-2N3906-0L
Q611	Transistor	14-2N3906-0L
Q612	Transistor	14-2N3904-0L
Q700	Transistor 300V 2W 2N6558	14-000951-12
Q701	Transistor PNP 300V .5A	14-000950-12
Q702	Transistor 300V 2W 2N6558	14-000951-12
Q703	Transistor 2N5656	14-000974-13
Q704	Transistor MJE 350	14-000975-13
Q707	Transistor	14-2N3904-0L
Q708	Transistor	14-2N3906-0L
Q709	Transistor	14-2N3904-0L
Q710	Transistor	14-2N3906-0L
Q711	Transistor	14-2N3906-0L
Q712	Transistor	14-2N3904-0L

## CAPACITORS

Symbol	Description	Electrohome Part Number
C401	Capacitor 1000uF 80V	44-510207-03
C402	Capacitor 680uF 160V	44-768207-00
C403	Capacitor 680uF 80V	44-768207-11
C404	Capacitor 680uF 80V	44-768207-11
C405	Capacitor 10uF 25V	84-410004-01
C406	Capacitor 10uF 25V	84-410004-01
C407	Capacitor 100NF 200V	48-171042-32
C410	Capacitor 100NF 200V	48-171042-32
C411	Capacitor 22uF 250V	44-322010-10
C600	Capacitor 2.2pF 500V 10%	46-322713-01
C601	Capacitor 47uF 16V	84-447003-02
C622	Capacitor 100pF 500V	86-310113-01
C625	Capacitor 560pF 500V	86-356127-01
C626	Capacitor 4N7 100V 10%	86-171721-02
C627	Capacitor 47uF 10V	84-447002-01
C628	Capacitor 47uF 10V	84-447002-01
C642	Capacitor 2N2 200V	48-172272-02
C701	Capacitor 47uF 16V	84-447003-02

# PARTS LIST

E.H.T. SUPPLY ASS'Y G08-105 03-170034-01

## SEMICONDUCTORS

Symbol	Description	Electrohome Part Number
IC900	EHT control circuit	14-002155-01
IC901	Regulator .7A 125V	14-006016-01
ZD903	Zener Diode 5.1V	14-000515-44
ZD904	Zener Diode 5.1V	14-000515-44
ZD905	Zener Diode 5.1V	14-000515-44
D901	Rectifier 1A 1400V	28-000022-25
D902	Rectifier 1A 200V	28-000022-28
Q901	Transistor 2N3906	14-000873-82
Q902	Transistor 2N4401	14-000752-32
Q903	Transistor 2N3904	14-000878-82

## TRANSFORMERS

Symbol	Description	Electrohome Part Number
T900	Horizontal Buffer Trans.	24-170001-07
T901	Flyback Trans.	21-000258-01

## COILS

Symbol	Description	Electrohome Part Number
L900	Horizontal delay choke	21-001410-01

## CAPACITORS

Symbol	Description	Electrohome Part Number
C900	Capacitor .22 50V	89-000032-01
C901	Capacitor .22 50V	89-000032-01
C902	Capacitor 220NF Met. Poly	88-050000-03
C903	Capacitor .0022uF 50V	89-000032-07
C904	Capacitor 470uF 16V	44-447103-26
C905	Capacitor 22uF 16V	84-422003-01
C906	Capacitor 100NF 100V	4B-171041-22
C907	Capacitor 22NF 100V	4B-172231-22
C911	Capacitor 100uF 16V	44-010134-24
C914	Capacitor 270pF 3000V	46-527113-30
C915	Capacitor 1N2 1600V	49-000019-06
C916	Capacitor 47uF 160V	44-347009-08
C917	Capacitor 100NF 200V	4B-171042-22
C918	Capacitor 47NF 100V	48-174731-02
C919	Capacitor 470uF 16V	44-447103-26
C921	Capacitor 220NF Met. Poly	88-050000-03

## RESISTORS

Symbol	Description	Electrohome Part Number
R900	10K .25W 5%	40-121035-31
R901	39K .25W 5%	40-123935-31
R902	39K .25W 5%	40-123935-31
R903	10K .25W 5%	40-121035-31
R904	150K .25W 5%	40-121545-31
R905	12K .25W 5%	40-121235-31
R906	10K .25W 5%	40-121035-31
R907	4K7 .25W 5%	40-124725-31
R910	470K .5W 5%	40-224745-31
R914	1K2 .25W 5%	40-121225-31
R915	11K .25W 5%	40-121135-31
R916	150K .25W 5%	40-121545-31
R917	200R Control	41-000331-10
R918	2K Control	41-000331-06
R923	270R .25W 5%	40-122715-31
R924	470R .25W 5%	40-124715-31
R925	18R .5W 5%	40-221805-31
R927	33R .25W 5%	40-123305-31
R930	68R .25W 5%	40-126805-31
R932	.68R 1W	40-526881-01
R933	470K Control	41-000331-24
R934	150K .25W 5%	40-121545-31
R935	33K .25W 5%	40-123335-31
R936	270K .25W 5%	40-122745-31
R937	4M7 .5W 5%	40-224755-31
R938	4K7 .25W 5%	40-124725-31
R939	4K7 .25W 5%	40-124725-31
R940	110R .5W 10%	40-221111-31
R941	47R 1W 5%	40-424705-01
R942	6K2 .25W 5%	40-126225-31
R943	82R .25W 5%	40-128205-31
R945	1K .1W 20% Trimpot	41-000265-05
R946	5R0 .25W 5%	40-125005-31
R947	22R .25W 5%	40-122205-31
R948	47R .25W 5%	40-124705-31
R949	5K0 2W 10%	40-025621-01
R950	1K .25W 5%	40-121025-31

**RESISTORS (cont'd)**

Symbol	Description
R134	1K2 .25W 5%
R136	2K5 Triopot
R137	22K .5W 5%
R138	100R .25W 5%
R139	1K .25W 5%

**Electrohome Part Number**

40-121225-31
41-000299-26
40-222235-31
40-121815-31
40-121025-31

**HEAT SINK ASS'Y**

Symbol	Description
Q605	Transistor 5A 180V
Q606	Transistor 5A 180V
Q705	Transistor 5A 180V
Q706	Transistor 5A 180V
M01	Motor Blower Fan

**Electrohome Part Number**

14-000601-46
14-000601-46
14-000601-46
14-000601-46
25-000062-01

STD 1064 (Silicon Triopot Cont.)

**MISCELLANEOUS**

Symbol	Description
V01	Picture Tube
DY01	Deflection Yoke
L400	Degaussing Coil
J101	Picture Tube PCB Socket

**Electrohome Part Number**

17-007198-15
21-000145-02
21-001007-27
34-000773-03

**△ SAFETY COMPONENTS △**

**DEFLECTION AMP PCB ASS'Y**

Symbol	Description
F400, F401	5A 125V Slow Blow Fuse
F600, F700	5A 250V Fast Blow Fuse
R648, R649, R748, R749	.47R 2W Resistor
R626, R629, R636, R638, R726, R729, R735, R738	100R .25W Resistor

**Electrohome Part Number**

27-000005-35
27-000014-20
42-000063-68

**E.H.T. SUPPLY PCB ASS'Y**

Symbol	Description
T901	Flyback
C906	Capacitor 100NF 100V
CB14	Capacitor 270pF 3000V
C915	Capacitor 1N2 1000V
C918	Capacitor 47NF 100V
R914	1K2 .25W 5% Resistor
R917	200R Control
R935	33K .25W 5% Resistor
R937	4M7 .5W 5% Resistor

**Electrohome Part Number**

21-000258-01
48-171041-22
46-527113-30
49-000019-06
48-174731-02
40-121225-31
41-000331-10
40-123335-31
40-224755-31

**E.H.T. SUPPLY ASS'Y KIT**

Symbol	Description
R922	Focus Control

**Electrohome Part Number**

41-000342-02
--------------