

G E T T I N G S T A R T E D

9100



Contents

Where Am I?	v
Overview	1
Unpacking	5
9100A System Components.....	6
9105A System Components.....	8
Optional Components.....	10
Hardware and Connections	11
Mainframe.....	12
Probe.....	16
Pod.....	20
Clock Module.....	24
I/O Module.....	28
I/O Module Adapters (several versions available).....	32
Calibration Module.....	36
Monitor.....	38

P/N 787960

APRIL 1987 Rev.1, 1/88

© 1988, John Fluke Mfg. Co., Inc.
All rights reserved. Litho in U.S.A.

Programmer's Keyboard.....	40
Communication Ports.....	42
Printers.....	44
Multi-Function (SCSI) Interface (9100A only).....	45
External Switch Interface.....	46
Power-Up.....	47

Index

Figures

1:	9100A System, with Programmer's Station.....	7
2:	9105A System.....	9
3:	Mainframe Front View.....	13
4:	Mainframe Rear View	14
5:	Mainframe Right-Side View.....	15
6:	Probe.....	17
7:	Probe Connection.....	19
8:	Pod.....	21
9:	Pod Connection.....	23
10:	Clock Module.....	25
11:	Clock Module Connection.....	27
12:	I/O Module.....	29
13:	I/O Module Connection.....	31
14:	I/O Module Adapters.....	33
15:	I/O Module Adapter Connection.....	35
16:	Calibration Module and Connection.....	37
17:	Monitor and Connection.....	39
18:	Programmer's Keyboard and Connection.....	41

Where Am I?

Getting Started



A description of the parts of the 9100A/9105A, what they do, how to connect them, and how to power up.

Automated Operations Manual



How to run pre-programmed test or troubleshooting procedures.

Technical User's Manual



How to use the 9100A/9105A keypad to test and troubleshoot your Unit Under Test (UUT).

Applications Manual



How to design test or troubleshooting procedures for your Unit Under Test (UUT).

Programmer's Manual



How to use the programming station with the 9100A to create automated test or troubleshooting procedures.

TL/1 Reference Manual



A description of all TL/1 commands arranged in alphabetical order for quick reference.

Overview

The Fluke 9100A and 9105A systems are designed to test and troubleshoot boards containing microprocessors. A single 9100A/9105A system can test or troubleshoot boards containing many different types of microprocessors. This is done by attaching a pod which is compatible with the microprocessor on the board to be tested (called the Unit Under Test or UUT).

The 9100A/9105A systems are easily integrated into testing environments for routine single-step tests or for complex automated troubleshooting of boards that have failed tests.

The systems use Guided Fault Isolation (GFI) algorithms which help automate the task of backtracing from faulty nodes to good nodes so as to identify the cause of faults with a minimum of operator time and effort.

With both the 9100A and the 9105A you can

- Determine whether the UUT (Unit Under Test) is good or bad using built-in functional tests or functional tests designed by your engineers.
- Run the UUT without intervention from the 9100A/9105A (the RUN UUT key).
- Isolate faults in bad boards.
- Communicate with another computer or transmit to a printer via an RS-232 port.

With the 9100A (only), you can also

- Create customized test procedures.
- Create customized troubleshooting procedures to isolate faults.
- Use the Programmer's Station as a computer terminal.
- Write or edit text documents.
- Connect Small Computer System Interface (SCSI) peripherals, such as disk storage and tape backup, through the Multi-Function Interface.

*Using the 9100A/9105A
manual set*

Everyone who uses the 9100A/9105A should read this manual. It tells you how to connect the various components that may be included with your system. After reading this manual, you can go on to the other manuals according to your needs:

- **Operators** who run previously written test or troubleshooting programs, go to the *Automated Operations Manual*.
- **Troubleshooting Technicians** who troubleshoot faulty boards using the 9100A/9105A in immediate mode, go to the *Technical User's Manual*.
- **Test Designers** who devise automated test and troubleshooting procedures, go to the *Applications Manual*.
- **Programmers** who write test and troubleshooting programs, go to the *Programmer's Manual* and the *TL/1 Reference Manual*.

Selecting a location for your system

Select a level surface which has ample space for all components. The work location should include a standard, grounded electrical outlet (two outlets for the 9100A with Programmer's Station), ventilation, and protection from excessive dust, debris, extreme temperatures, and static electricity. The work location should also be free of electrical and magnetic interference.

Unpacking

Inspect each component of your system for possible shipping damage after you remove the components from the shipping box. If you notice shipping damage or missing items, contact your shipping agent or your Fluke sales representative immediately.

Save the original shipping box and protective shipping devices, including foam packing and disk cardboard inserts. If repairs, equipment relocation, or extended storage are necessary, use the original foam-packed shipping containers to prevent unnecessary damage. If the original packaging is not available, order new containers from your Fluke sales representative.

The components that comprise the 9100A and the 9105A systems are shown on the following pages. While unpacking, you can use these pages to check that you have received all the components appropriate for your order.

9100A System Components

The 9100A system (Figure 1) is used for executing pre-programmed tests and troubleshooting procedures or for immediate-mode testing and troubleshooting using the keys on the operator's keypad. In addition, when equipped with the Programmer's Station, it is used to write automated test and troubleshooting programs.

The components of a standard 9100A are:

- One 9100A mainframe, which contains one internal 20-megabyte hard disk drive, and one 3.5-inch disk drive.
- One probe.
- One clock module.
- One power cord.
- Four manuals:
 - Getting Started*
 - Automated Operations Manual*
 - Technical User's Manual*
 - Applications Manual*
- Three types of disks:
 - System Disk 1 and System Disk 2
 - Master User Disk 1 and Master User Disk 2
 - User Disks (ten blank, 3.5-inch disks)

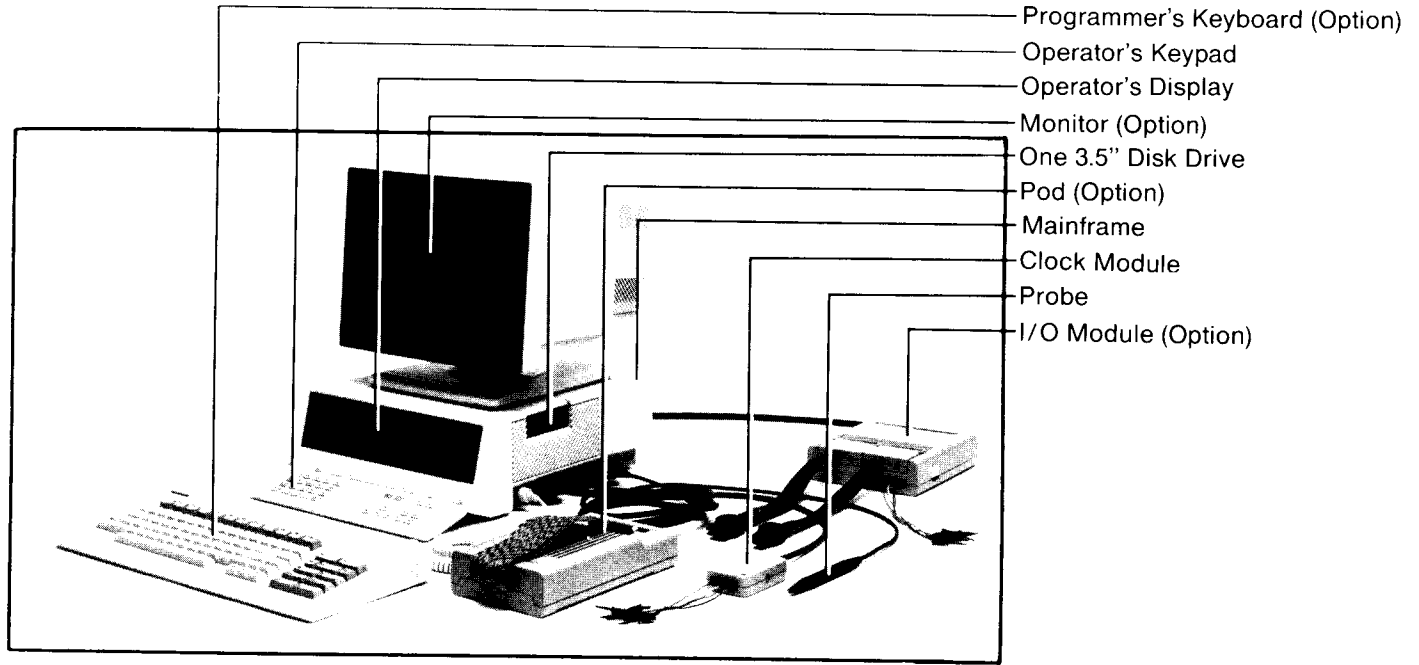

Figure 1: 9100A System, with Programmer's Station

9105A System Components

The 9105A system (Figure 2) is used for executing pre-programmed tests and troubleshooting procedures or for immediate-mode testing and troubleshooting using the keys on the operator's keypad.

The components of a standard 9105A are:

- One 9105A mainframe, which contains two 3.5-inch disk drives.
- One probe.
- One clock module.
- One power cord.
- Four manuals:
 - Getting Started*
 - Automated Operations Manual*
 - Technical User's Manual*
 - Applications Manual*
- Three types of disks:
 - System Disk 1 and System Disk 2
 - Master User Disk 1 and Master User Disk 2
 - User Disks (ten blank, 3.5-inch disks)

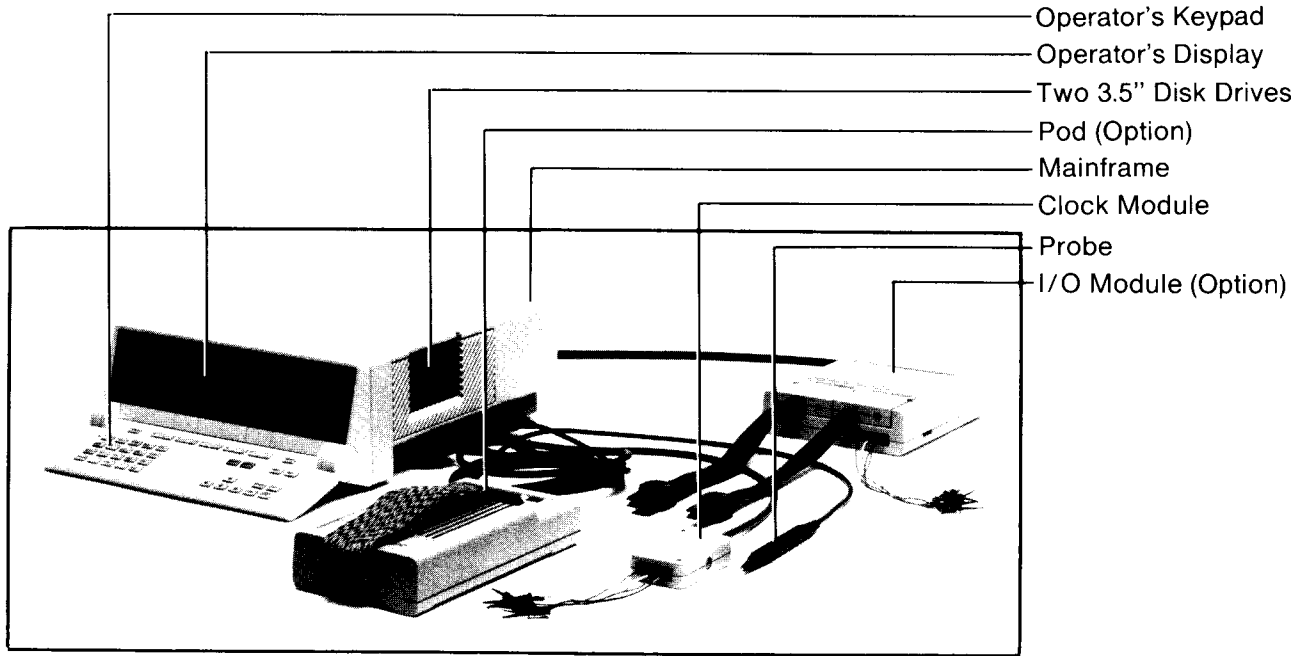

Figure 2: 9105A System

**Optional Components
(check your packing
list)**

- Pods (pods for over 45 microprocessors are available).
- I/O modules (up to four).
(Each I/O module comes with one calibration module.)
- I/O module adapters (several available).
- Programmer's Station (9100A only), including:
 - Monitor
 - Programmer's keyboard
 - Power cord
 - Video cable
 - Programmer's Manual*
 - TL/1 Reference Manual*
 - Programmer System Disk
 - Video card (installed in mainframe when ordered with the mainframe).

Hardware and Connections

The 9100A and 9105A are the newest members of Fluke's family of digital testers and troubleshooters. They are designed for fast, cost-effective automation of your test and troubleshooting procedures for microprocessor-based digital circuit boards.

The sections that follow give a pictorial overview of each component, showing names of the basic features, control mechanisms, and connectors. Detailed hardware specifications are included in the appendices of the *Technical User's Manual*.

Mainframe

The mainframe (Figure 3) is the heart of the 9100A/9105A. It contains the control logic, operator's keypad and display, component connectors, disk storage devices, and the power supply.

The built-in operator's keypad is used for test-data entry and operator control. When the keypad is flipped up (closed), the mainframe makes a convenient package for transport or storage. When the keypad is pulled down, it reveals the keypad keys and the operator's display (a built-in, three-line electroluminescent screen). Instructions to the operator are displayed on this screen and operator commands are entered through this keypad.

Switches and connectors are located on the rear (Figure 4) and right-side (Figure 5) of the mainframe. Disk drives are also located on the right-side of the mainframe. The 9100A contains one 3.5-inch disk drive and a 20-megabyte internal hard disk drive. The 9105A contains two 3.5-inch disk drives.

The following sections describe each system component and how to connect each component to the mainframe.

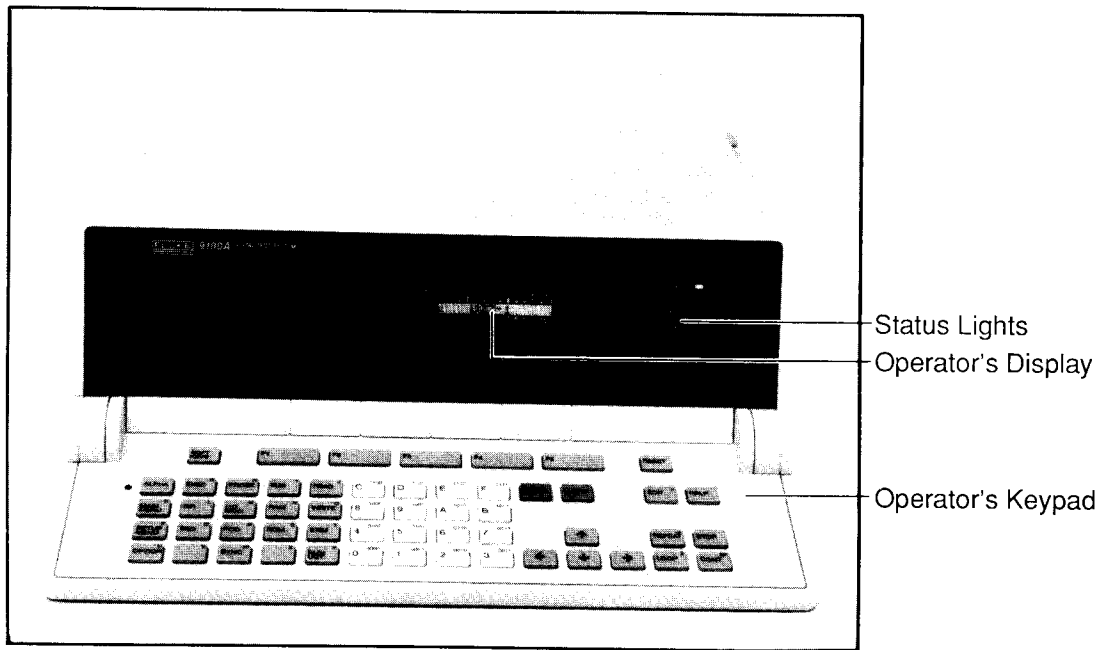

Figure 3: Mainframe Front View

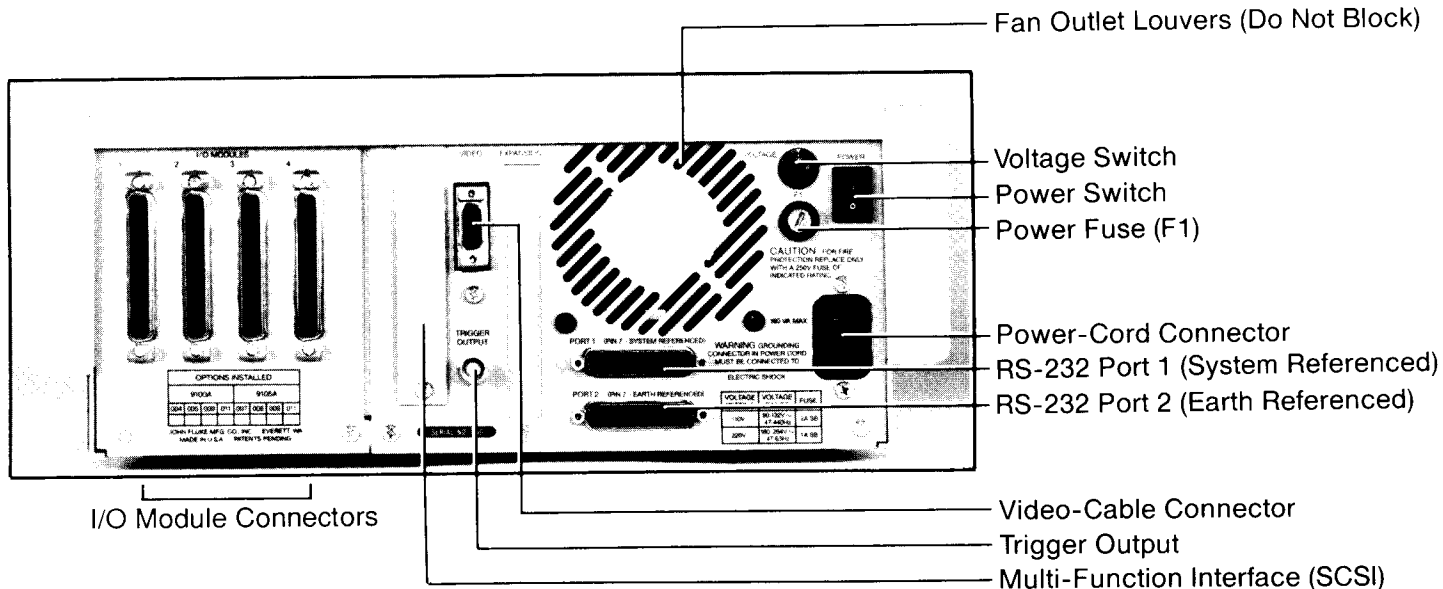
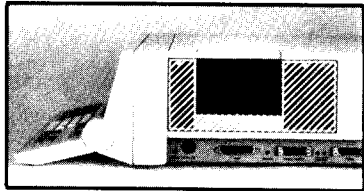
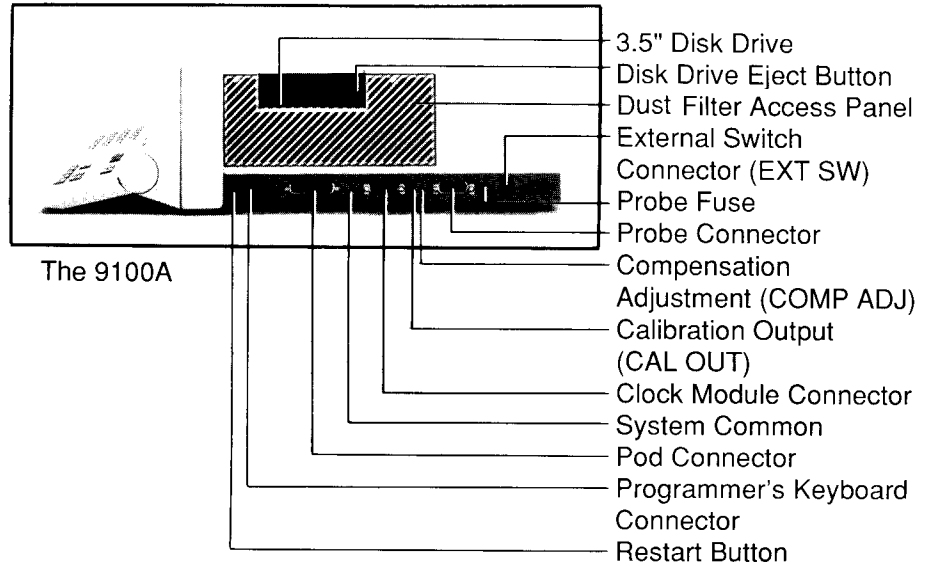

Figure 4: Mainframe Rear View



The 9105A showing its different disk drive arrangement.

Figure 5: Mainframe Right-Side View

Probe

The probe (Figure 6) is used to access test points on the UUT, such as individual pins of an integrated circuit.

The probe contains a push-button (called a ready button) and a common clip. The common clip is to be connected to UUT common. When the ready button is pressed, it signals the system to start a measurement cycle. Colored lights on the probe indicate the logic level of a measurement:

- **Red** is high.
- **Yellow** is high-impedance (3-state) or an invalid level.
- **Green** is low.

The removable probe tip can be replaced with a flying-lead clip which allows connection to a UUT test point.

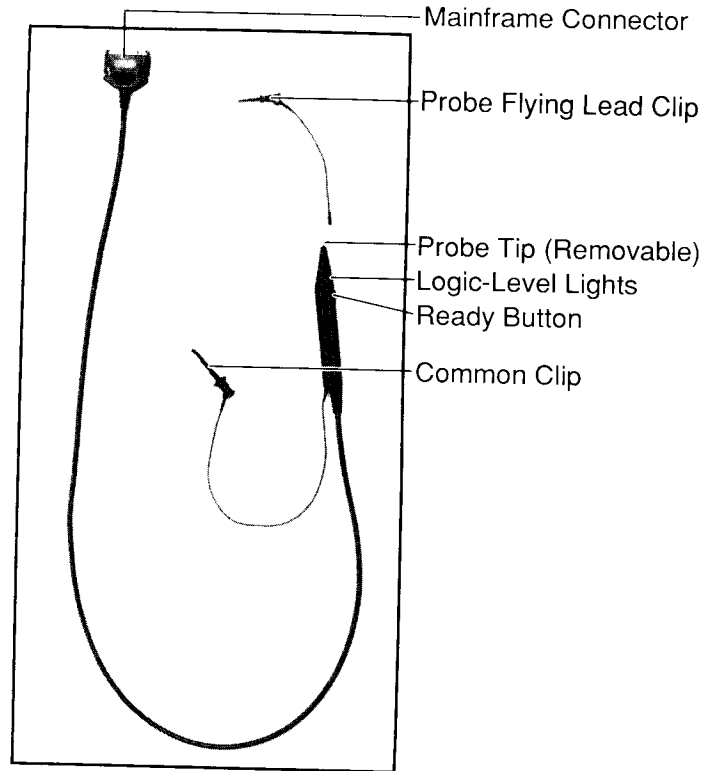

Figure 6: Probe

To connect the probe to the mainframe

Connect the probe's cable to the 15-pin PROBE connector located on the right side of the mainframe as shown in Figure 7.

To change the probe fuse

The probe fuse provides protection from power supply shorts or other over-current conditions caused by misplacement of the common clip. If the probe fuse blown message appears on your display, disconnect the common clip and replace the PROBE FUSE located next to the PROBE connector on the mainframe (Figure 7).

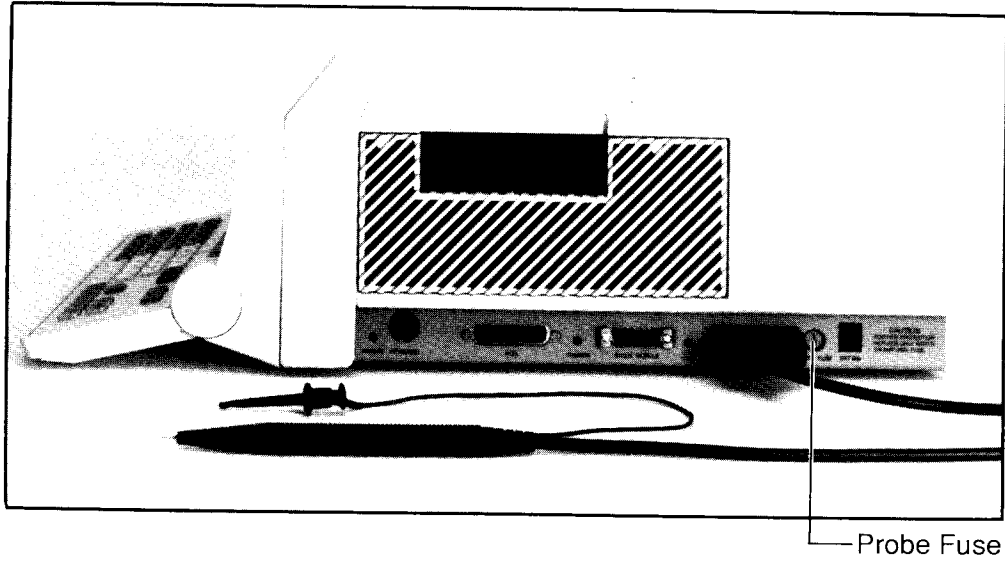

Figure 7: Probe Connection

Pod

A typical pod is shown in Figure 8. What your pod looks like depends on which pod you ordered for your system. The pod is microprocessor-specific; therefore, the pod that you choose must be appropriate for the microprocessor that your UUT uses. Check with your Fluke sales representative for details. Each pod has its own separate instruction manual.

The pod is used to interface the 9100A/9105A mainframe to the UUT microprocessor bus. This interface allows rapid detection of problems on a microprocessor-based UUT, rapid fault isolation, and also the capability to run the UUT using its own normal program.

The pod also has a self-test socket which is used to test the pod's integrity. When the pod is not in use, plug the UUT connector into this socket for protection against physical damage. Engage the locking mechanism, if present, to lock the connector into the socket.

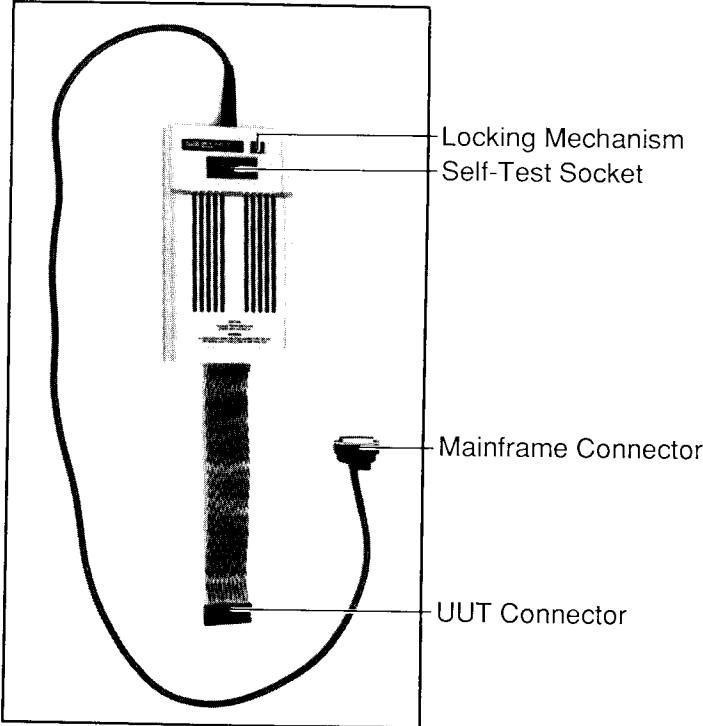

Figure 8: Pod

To connect the pod to the mainframe

1. Connect the pod's cable to the 25-pin POD connector located on the right side of the mainframe as shown in Figure 9. If necessary, disengage the cable-locking mechanism on the end of the cable by sliding it towards the front of the mainframe.
2. Engage the cable-locking mechanism by sliding it towards the back of the mainframe.

To connect the pod to the UUT

See the pod's instruction manual. Do not connect the pod to the UUT until after doing self-tests, calibration, and configuration as described in the "Self-tests, Configuration, and Calibration" section of the *Technical User's Manual*.

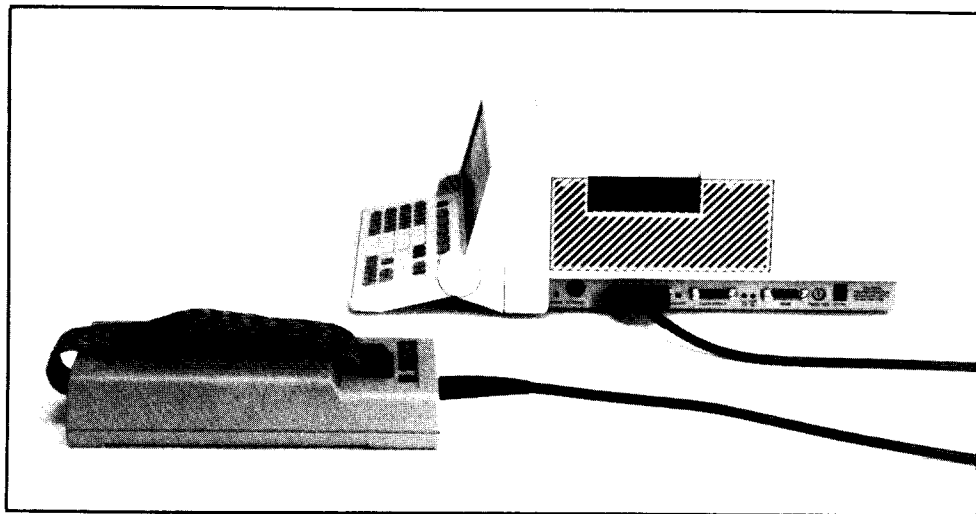

Figure 9: Pod Connection

Clock Module

The clock module (Figure 10) allows you to use signals from the UUT to synchronize data input and output through the probe.

The clock module is connected to the UUT through the five measurement control lines:

COMMON	-	black.
ENABLE	-	blue.
CLOCK	-	yellow.
STOP	-	red.
START	-	green.

The spring-loaded clips can be removed from the ends of the measurement control lines, making it possible to connect directly to test-points or breadboard posts.

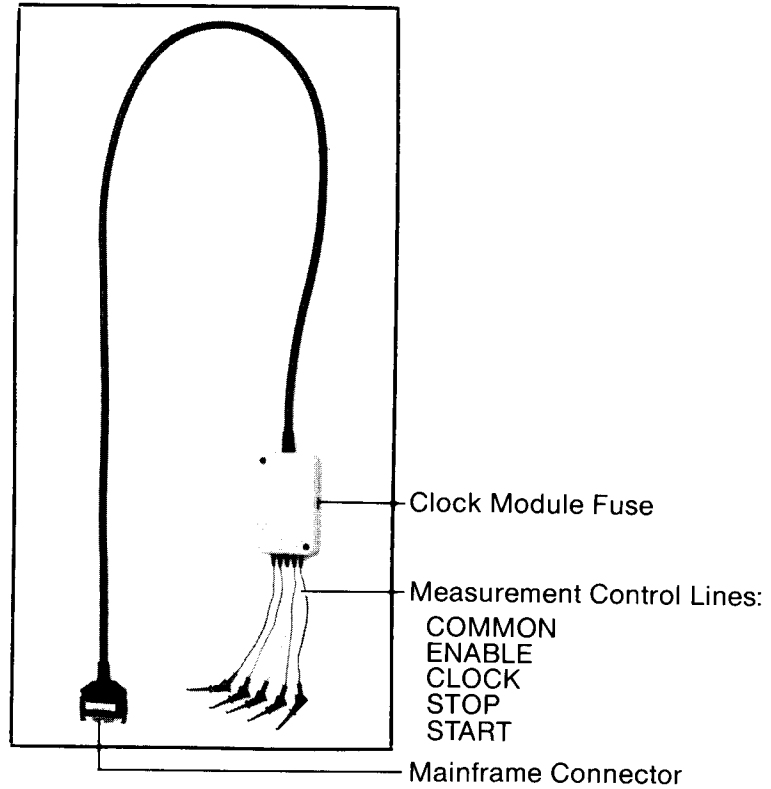

Figure 10: Clock Module

To connect the clock module to the mainframe

Connect the clock module's cable to the 15-pin CLOCK MODULE connector located on the right side of the mainframe as shown in Figure 11.

To change the clock module fuse

The clock module fuse provides protection from power supply shorts or other over-current conditions caused by misplacement of the COMMON lead. If the clock module fuse blown message appears on your display, disconnect the COMMON lead and replace the fuse located on the clock module (Figure 10).

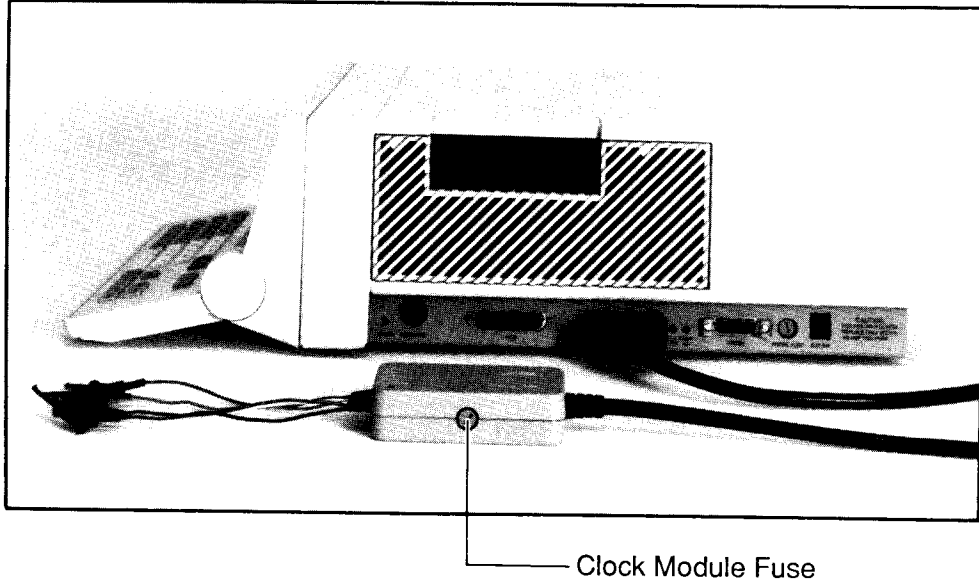

Figure 11: Clock Module Connection

I/O Module

An I/O module (Figure 12) allows the 9100A/9105A system to access up to 40 test points simultaneously. The system supports up to four I/O modules at a time.

Data collection or stimuli may be controlled either internally, or when external control is necessary, by the five measurement control lines:

COMMON	-	black.
ENABLE	-	blue.
CLOCK	-	yellow.
STOP	-	red.
START	-	green.

These control lines are similar to those of the clock module. I/O modules have an alternate set of measurement control line connectors on the side of the module. These alternate post-type connectors are used for daisy chaining the measurement control lines of multiple I/O modules. The alternate set contains one additional line, a DCE (data compare equal) output line.

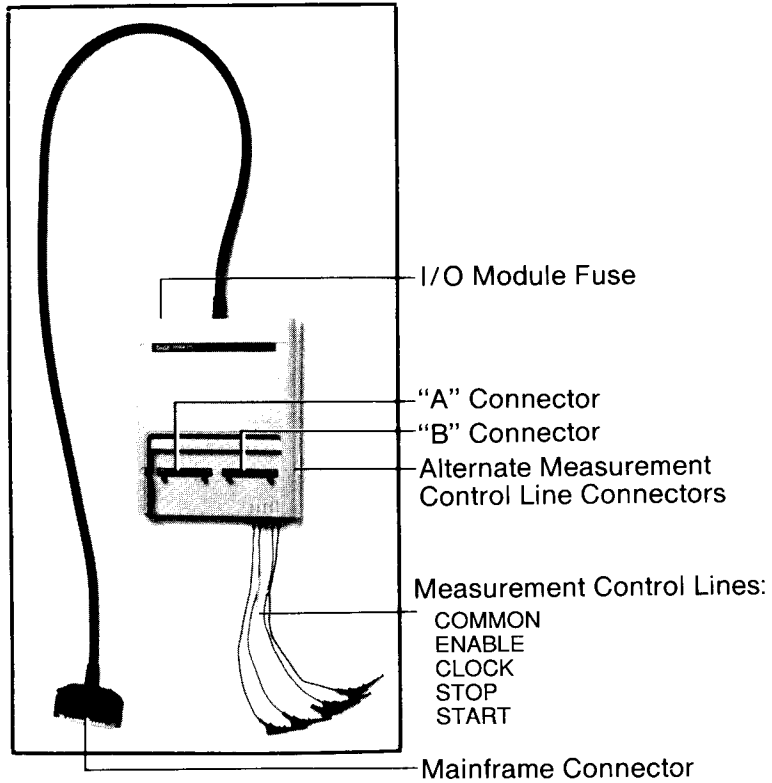

Figure 12: I/O Module

To connect an I/O module to the mainframe

Connect the I/O module's cable to one of the 37-pin I/O MODULE connectors located on the rear of the mainframe as shown in Figure 13.

The 9100A/9105A is shipped with anti-static covers over the I/O module connectors. These covers should remain in place when not using I/O modules.

To change an I/O module fuse

The I/O module fuse provides protection from power supply shorts or other over-current conditions caused by misplacement of the COMMON lead. If the I/O module fuse blown message appears on your display, disconnect the COMMON lead and replace the fuse located on the I/O module (Figure 13).

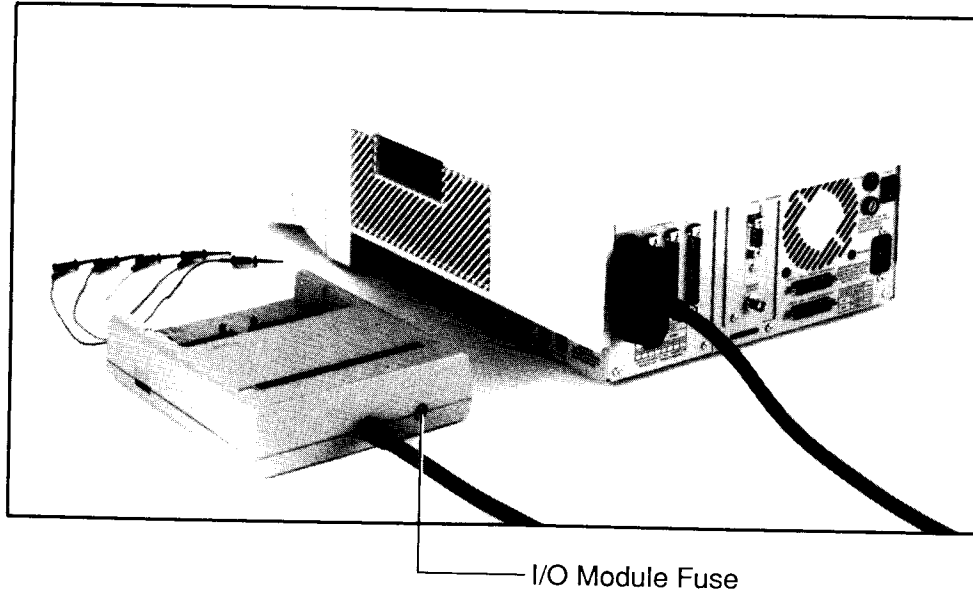

Figure 13: I/O Module Connection

**I/O Module Adapters
(several versions
available)**

An I/O module adapter (Figure 14) plugs into an I/O module at one end and is used to interface with parts of the UUT at the other end. One or two I/O module adapters (depending on their size) can plug into an I/O module at the same time. Three different I/O module adapters, from the several sizes available, are shown in Figure 14.

Each I/O module adapter contains a push-button (called a ready button) and a common clip. The common clip is to be connected to UUT common. When the ready button is pressed, it signals the system to start a measurement cycle.

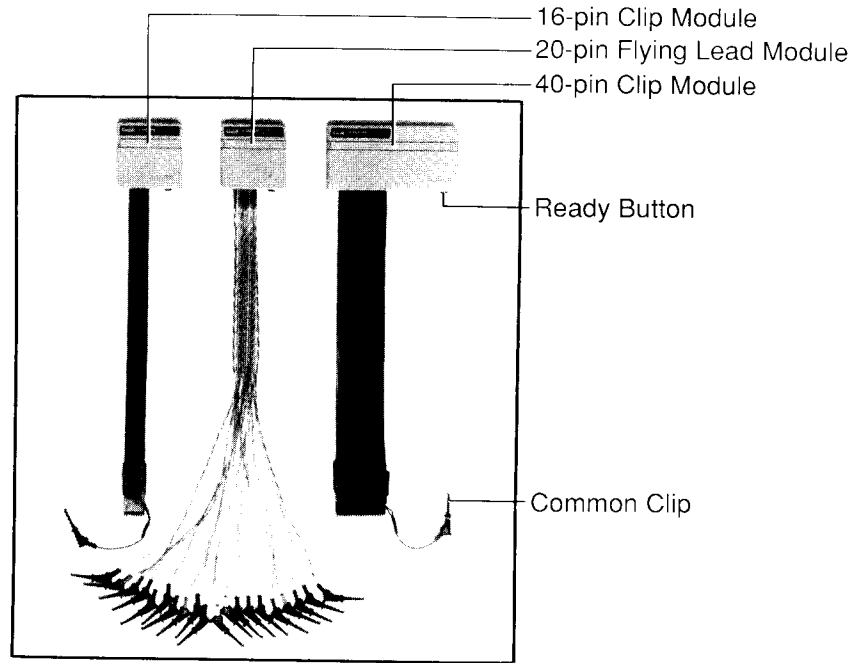

Figure 14: I/O Module Adapters

NOTE

The I/O module adapters are keyed by alignment tabs to prevent inserting incorrect combinations in an I/O module. For example, a 24-pin clip module can be used with a 16-pin clip module, but a 24-pin clip module cannot be used with a 20-pin clip module.

To connect an I/O module adapter to an I/O module

1. Locate the two 33-pin connectors marked "A" and "B" on the I/O module. As shown in Figure 15, two small adapters, or one large adapter can fit into an I/O module.
2. After aligning the tabs, press the adapter into one or both of the connectors, depending on the size of the adapter.

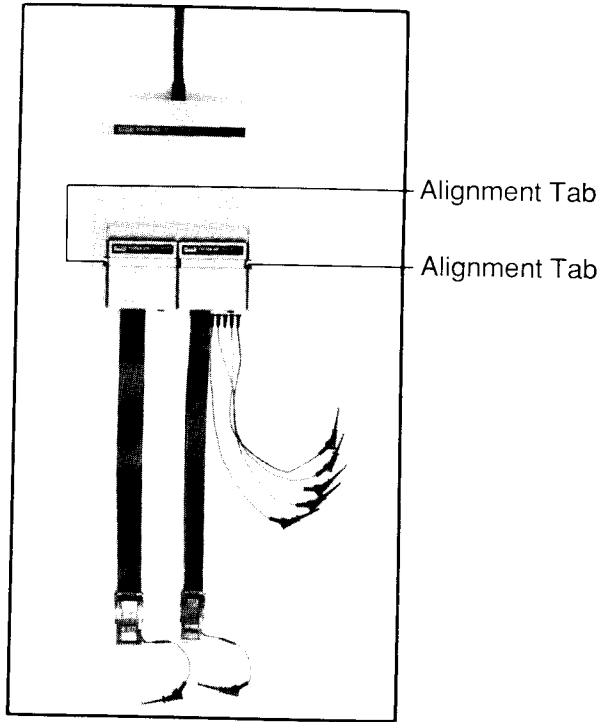

With Two Small Clip Modules

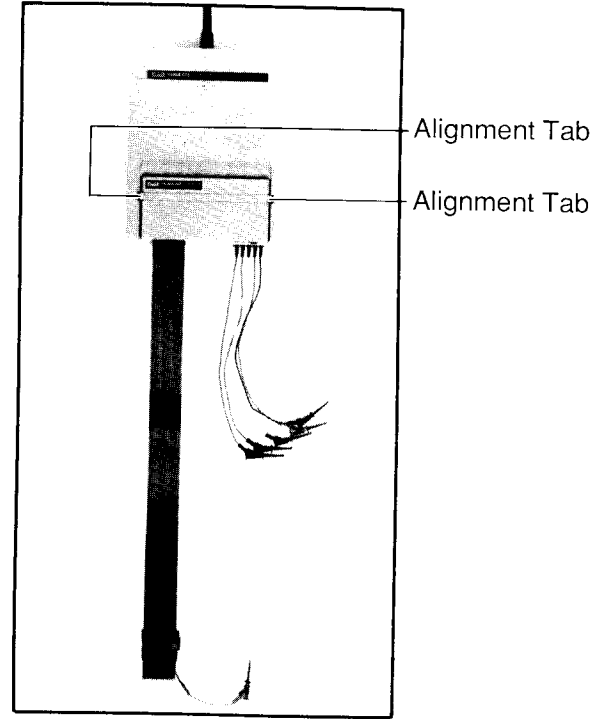

With One Large Clip Module

Figure 15: I/O Module Adapter Connection

Calibration Module

The calibration module (Figure 16) is used to calibrate an I/O module as described in the "Self-tests, Configuration, and Calibration" section in the *Technical User's Manual*. One calibration module is provided with each I/O module.

The calibration module contains a push-button (called a ready button) and a calibration input lead. When the ready button is pressed, it signals the system that the calibration input lead is connected as directed and that the calibration process may then continue.

To connect the calibration module to an I/O module

After aligning the tabs, press the calibration module over both connectors, marked "A" and "B", on the I/O module as shown in Figure 16.

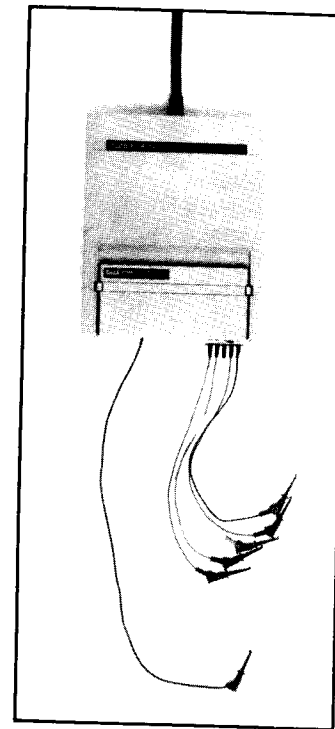
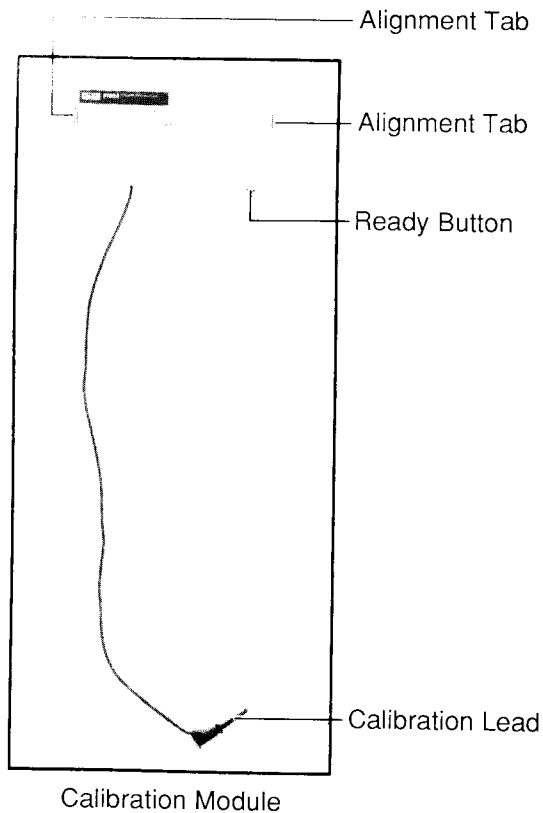

Figure 16: Calibration Module and Connection

Monitor

The monitor (Figure 17) is a CRT screen which displays up to 24 rows by 80 columns of text. The programmer uses the monitor to view programs entered at the keyboard. The 9100A/9105A can be programmed to display messages to the operator on the monitor as well as on the operator's display.

To connect the monitor to the mainframe

Connect the video cable to the 9-pin VIDEO connectors located on the back of the monitor and the back of the mainframe as shown in Figure 17.

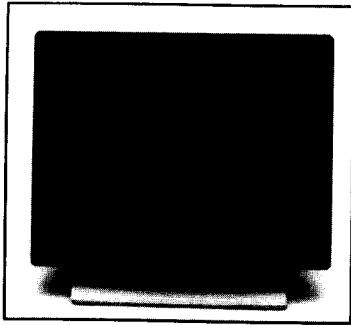

Front View

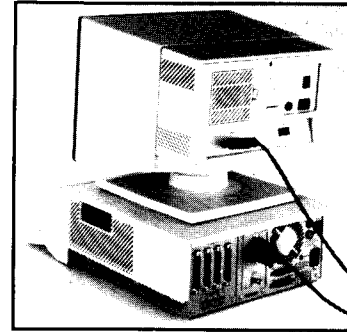

Connection

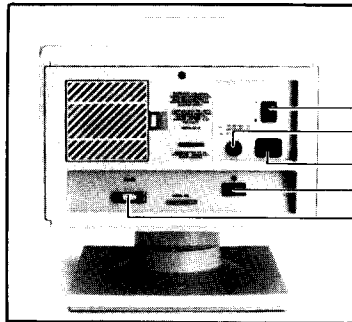

Rear View

- Power Switch
- Voltage Switch
- Power-Cord Connector
- Contrast Control
- Video-Cable Connector

Figure 17: Monitor and Connection

Programmer's Keyboard

The programmer's keyboard (Figure 18) is an alphanumeric keyboard similar to those found on personal computers. The programmer uses the keyboard to enter programs.

The keyboard features sculptured keycaps, function keys, and a coiled cord.

*To connect the keyboard to
the mainframe*

Insert the keyboard's cable into the 5-pin KEYBOARD connector located on the right side of the mainframe as shown in Figure 18.

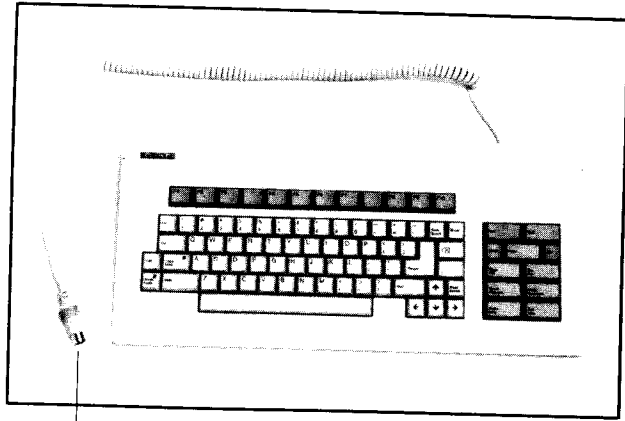

Programmer's Keyboard

Mainframe Connector

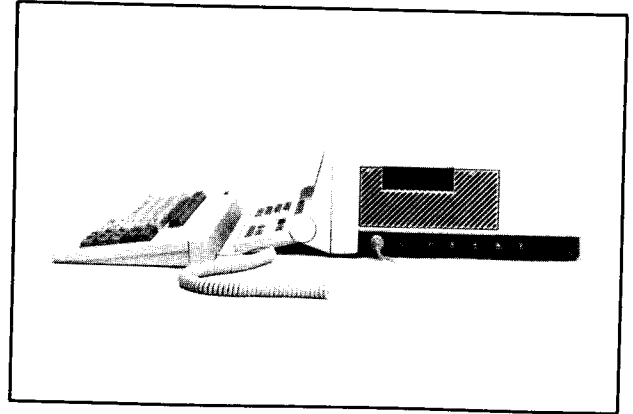

Connection

Figure 18: Programmer's Keyboard and Connection

Communication Ports

The mainframe contains two RS-232 communication ports (Figure 4) which can connect the system to printers, remote computers, and other peripheral devices. Each port has a standard DB-25 connector.

The two communication ports are labelled PORT1 and PORT2 and have the following characteristics:

- **Port 1** - Pin 7 (Signal Ground) on this port is *isolated* from the 9100A/9105A chassis earth ground. Pin 7 is tied to a common system reference, not the 9100A/9105A chassis earth ground. When making connections to the UUT, this port can be used in order to maintain ground isolation. You may also use this port for other RS-232 applications.

NOTE

If a peripheral connected to this port has its common system reference connected to earth ground, it will cause the UUT common system reference to be connected to earth chassis ground as well.

- **Port 2** - Pin 7 (Signal Ground) is tied to the 9100A/9105A chassis earth ground (it is *not isolated*). Use this port for peripherals (such as printers and other computers) where a separate ground reference is not required.

The 9100A/9105A is shipped with anti-static covers over the RS-232 port connectors. These covers should remain in place when not using the ports.

Printers

Your system can be connected to printers which have an RS-232 serial interface and an ASCII character set.

To connect a printer to the mainframe

Connect the RS-232 connector on your printer's cable to one of the communication ports located on the back of the mainframe (Figure 4).

NOTE

Usually the printer should be connected to port 2, where pin 7 of the connector is connected to chassis earth ground. If port 1 is used and if the printer has an internal connection between common system reference and chassis earth ground, it will cause the UUT common system reference to be connected to earth chassis ground as well.

Multi-Function (SCSI) Interface (9100A only)

*To connect a SCSI
peripheral to the mainframe*

The multi-function interface uses the popular Small Computer Systems Interface (SCSI) standard. It provides high-speed access to hard disks, tape backup systems, and other mass storage devices.

Connect the device's cable to the 50-pin MFI connector located on the back of the mainframe (Figure 4).

The 9100A is shipped with a metal anti-static plate over the SCSI port connector. If the port is to be used, remove the screw holding the plate to the rear panel, slide the plate out, and replace the screw on the rear panel of the 9100A. This anti-static plate should remain in place when not using the SCSI port.

External Switch Interface

A switch, which normally remains open, may be connected to the system via the external switch (EXT SW) interface (Figure 4). A test program can use such a switch to make a program depend on an external event, a manually generated signal, or a limit.

The interface between a switch and the mainframe is a telephone receiver jack located on the right side of the mainframe.

The connections at the pins of this jack are shown in the figure below.

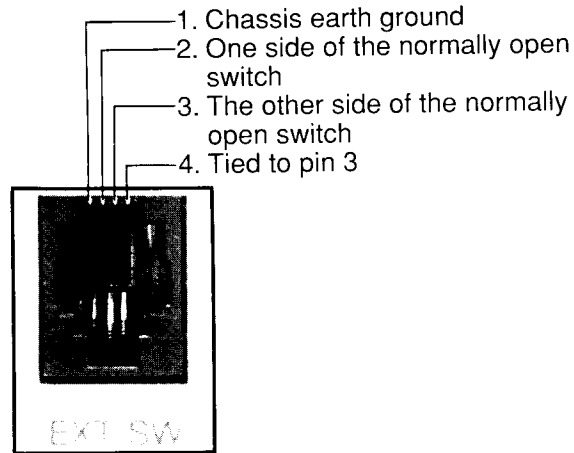

Power-Up

To connect the mainframe to AC power

If you have made all of the connections described in the previous section which apply to your particular configuration, you are ready to connect the power cord(s) and power-up.

1. Place the mainframe near the electrical outlet.
2. Flip down the operator's keypad on the front of the mainframe to reveal the operator's display.
3. Insure that the power switch on the rear of the mainframe is in the 0 (off) position.

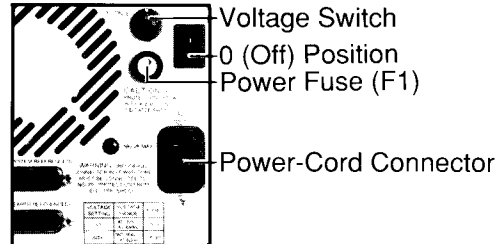

4. Set the voltage switch to match your local line voltage. If you change the voltage switch setting, you should check the power fuse according to the chart below:

<i>Voltage-Switch Setting</i>	<i>Line-Voltage Range</i>	<i>Power Fuse</i>
110 V	90-130 VAC	2 A slow blow
220 V	180-264 VAC	1 A slow blow

5. Connect the power cord to the three-prong connector on the back of the mainframe, and to a grounded electrical outlet.

*To connect the monitor to
AC power*

1. Set the power switch located on the back panel of the monitor to the 0 (off) position. Set the 110/220 volt voltage switch to match your local line voltage.
2. Connect the power cord to the three-prong connector on the back of the monitor and to a grounded electrical outlet.

After power-up, you can adjust the monitor's contrast by turning the contrast control on the back of the monitor.

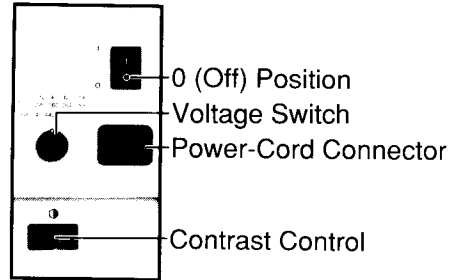

Powering up a 9100A system

1. Turn on the mainframe electrical power by setting the the power switch on the back of the mainframe (near the power cord) to the 1 (on) position. The system will proceed through its automatic power-up self-test.
2. If you are using a 9100A with a monitor, set the monitor's power switch to the 1 (on) position.
3. When the power-up procedure is completed, a ready message will appear on the operator's display.

If the ready message does not appear, see the "Power-up of a 9100A" section in the *Technical User's Manual*.

Self-tests and Calibration

The system may require self-testing or calibration in order to give accurate results. See the "Self-tests, Configuration, and Calibration" section in the Technical User's Manual for information on these procedures.

Powering up a 9105A system

1. Turn on the mainframe electrical power by setting the power switch on the back of the mainframe (near the power cord) to the 1 (on) position. The system will proceed through its automatic power-up self-test.
2. After the self-tests are completed, you will be prompted to insert the disk labelled "System Disk 1" into Drive 1 (the upper micro-floppy disk drive). The figure below shows the disk drives on a 9105A mainframe.

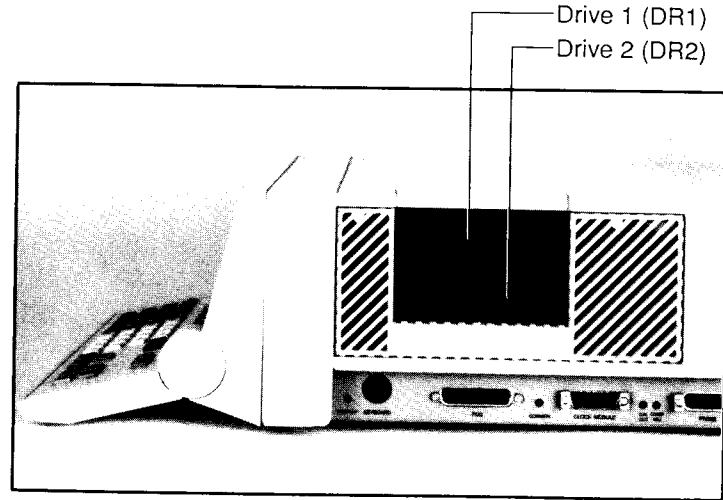

3. After the loading of System Disk 1 is completed, you will be prompted to insert System Disk 2 into Drive 1.
4. When the loading of System Disk 2 is completed, a ready message will appear on the operator's display. (If no pod is connected, an additional message will appear on the operator's display to tell you so.)

Self-tests and Calibration

The system may require self-testing or calibration in order to give accurate results. See the "Self-tests, Configuration, and Calibration" section in the Technical User's Manual for information on these procedures.

Index

9100A system components, 6
9105A system components, 8

Calibration, 50, 53

Calibration module, 10, 36

CLOCK, 24, 28

Clock module, 6, 8, 24

COMMON, 24, 28

Communication ports, 42

Connections

AC power, 47, 49

Calibration module, 36

Clock module, 26

External switch, 46

I/O module, 30

I/O module adapters, 34

Monitor, 38

Multi-function (SCSI) peripheral, 45

Pod, 22

Printers, 44

Probe, 18

Programmer's keyboard, 40
Control lines, 24, 28

Disk drives
3.5-inch, 12
9105A, 12, 51
Hard, 12

Display
Monitor, 10, 38
Operator's display, 12

ENABLE, 24, 28
External switch interface, 46

Fuses
Clock module, 26
I/O module, 30
Power, 48
Probe, 18

Hardware and connections, 11

I/O module, 10, 28

- I/O module adapters, 32
- Isolation from ground
 - Communication ports, 42,43
 - Printer, 44

Keyboard, 40

Location, selection of, 4

Logic-level lights, 16

Mainframe, 12

Manuals, 3, 6, 8, 10

Monitor, 10, 38

Multi-function (SCSI) interface (9100A only), 2, 45

Optional components, 10

Overview, 1

Pod, 10, 20

Power-up, 47

- 9100A system, 50

- 9105A system, 51

Printers, 44

Probe, 6, 8, 16
Programmer's keyboard, 10, 40
Programmer's station, 10

RS-232, 2, 42, 44

SCSI, 2, 45
Selecting a location for your system, 4
Self-testing, 50, 53
Shipping, 5
START, 24, 28
STOP, 24, 28

Tape backup, 2, 45

Unpacking, 5