


KNUCKLE BASH™

Universal Kit

Installation Instructions



For technical assistance:

If reading through this manual does not lead to solving your game maintenance or repair problem, call TELE-HELP® at one of these Atari Games Customer Service offices:

UNITED STATES

Atari Games Corporation
California Customer Service Office
737 Sycamore Drive
Milpitas, CA 95035

Fax (408) 434-3945
Telex 5101007850

☎ (408) 434-3950

(Monday–Friday, 7:30 a.m.–4:00 p.m. Pacific time)

EUROPE

Atari Games Ireland Limited
European Customer Service Office
Tipperary Town, Ireland

Fax 062-51702
Telex 70665

☎ 062-52155

(Monday–Friday, 9:00 a.m.–5:30 p.m. GMT)



The cover of this manual
is recycled paper



KNUCKLE BASH™

Kit Installation Instructions

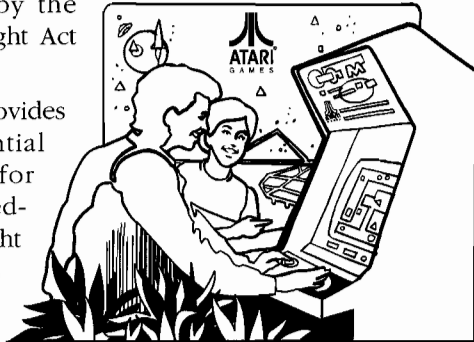
Conversion kit for two-player upright games

Copyright © 1993 by Atari Games Corporation. All rights reserved.

No part of this publication may be reproduced by any mechanical, photographic or electronic process, or in the form of a phonographic recording, nor may it be stored in a retrieval system, transmitted, or otherwise copied for public or private use, without permission from the publisher.

The game play, all graphic designs, this technical manual, its accompanying schematic diagrams, and the display manual are protected by the U.S. Copyright Act of 1976.

This Act provides for substantial penalties for violating federal copyright laws. Courts can im-



fringe articles while legal action is pending. If infringers are convicted, courts can order destruction of the infringing articles.

In addition, the Act provides for payment of statutory damages of up to \$50,000 per infringing transaction in certain cases. Infringers may also have to pay costs and attorneys' fees and face an imprisonment of up to five years as well as fines of up to \$250,000 in the case of individuals and up to \$500,000 in the case of corporations.

Atari Games Corporation will aggressively enforce its copyrights against infringers. We will use all legal means to immediately halt any manufacture, distribution, or operation of a copy of video games made by us. Anyone who purchases such copies risks forfeiting such a game.

Published by:
Atari Games Corporation
675 Sycamore Drive
Milpitas, California 95035

Printed in the U.S.A. 3/93

Produced by the Atari Games Technical Publications Department.

Writing and Editing: Andrea Dencker
Illustration and Design: Mary Ohanessian Sumner

NOTICE RE. NON-ATARI PARTS

WARNING

Use of non-Atari parts or modifications of any Atari game circuitry may adversely affect the safety of your game, and may cause injury to you and your players.

You may void the game warranty (printed on the inside back cover of this manual) if you do any of the following:

- Substitute non-Atari parts in the game.
- Modify or alter any circuits in the game by using kits or parts *not* supplied by Atari Games Corporation.

NOTE

This equipment generates, uses, and can radiate radio frequency energy, and if not installed and used in accordance with the instruction manual, may cause interference to radio communications. It has been tested and found to comply with the limits for a Class A computing device pursuant to Subpart J of Part 15 of Federal Communications Commission (FCC) Rules, which are designed to provide reasonable protection against such interference when operated in a commercial environment. Operation of this equipment in a residential area or modification to this equipment is likely to cause interference, in which case the user, at his own expense, will be required to take whatever measures may be required to correct the interference. If you suspect interference from an Atari game at your location, check the following:

- All ground wires in the game are properly connected as shown in the game wiring diagram.
- The power cord is properly plugged into a grounded three-wire outlet.
- On games provided with an Electromagnetic Interference (EMI) ground plane, be sure that the game printed-circuit boards (PCBs) are properly installed on the EMI ground plane and that the end board is securely installed with **all** screws in place and tightened.

If you are still unable to solve the interference problem, please contact Customer Service at Atari Games Corporation. See the inside front cover of this manual for service in your area.

S A F E T Y S U M M A R Y

The following safety precautions apply to all game operators and service personnel. Specific warnings and cautions will be found in this manual whenever they apply.

WARNING

Properly Ground the Game. Players may receive an electrical shock if this game is not properly grounded! To avoid electrical shock, do not plug in the game until it has been inspected and properly grounded. This game should only be plugged into a grounded three-wire outlet. If you have only a two-wire outlet, we recommend you hire a licensed electrician to install a three-wire grounded outlet. If the control panel is not properly grounded, players may receive an electrical shock! After servicing any part on the control panel, check that the grounding wire is firmly secured to the inside of the control panel. After you have checked this, lock up the game.

AC Power Connection. Before you plug in the game, be sure that the game's power supply can accept the AC line voltage in your location. The line voltage requirements are listed in the first chapter of this manual.

Disconnect Power During Repairs. To avoid electrical shock, disconnect the game from the AC power before removing or repairing any part of the game. If you remove or repair the video display, be very careful to avoid electrical shock. High voltages continue to exist even after power is disconnected in the display circuitry and the cathode-ray tube (CRT). Do not touch the internal parts of the display with your hands or with metal objects! Always discharge the high voltage from the CRT before servicing it. Do this after you disconnect it from the power source. First, attach one end of a large, well-insulated, 18-gauge jumper wire to ground. Then momentarily touch the free end of the grounded jumper wire to the CRT anode by sliding the wire under the anode cap. Wait two minutes and do this again.

Use Only Atari Parts. To maintain the safety of your Atari game, use only Atari parts when you repair it. Using non-Atari parts or modifying the game circuitry may be dangerous, and could injure you and your players.

Handle the CRT With Care. If you drop the CRT and it breaks, it may implode! Shattered glass from the implosion can fly six feet or more.

Use the Proper Fuses. To avoid electrical shock, use replacement fuses which are specified in the parts list for this game. Replacement fuses must match those replaced in fuse type, voltage rating, and current rating. In addition, the fuse cover must be in place during game operation.

CAUTION

Properly Attach All Connectors. Make sure that the connectors on each printed circuit board (PCB) are properly plugged in. The connectors are keyed to fit only one way. If they do not slip on easily, do not force them. If you reverse a connector, it may damage your game and void your warranty.

Ensure the Proper AC Line Frequency. Video games manufactured for operation on 60 Hz line power (used in the United States) must not be operated in countries with 50 Hz line power (used in Europe). If a 60 Hz machine operates on 50 Hz line power, the fluorescent line ballast transformer will overheat and cause a potential fire hazard. Check the product identification label on your machine for the line frequency required.

ABOUT NOTES, CAUTIONS, AND WARNINGS

In Atari publications, notes, cautions and warnings have the following meaning:

NOTE — A highlighted piece of information.

CAUTION — Equipment and/or parts can be damaged or destroyed if instructions are not followed. You will void the warranty on Atari printed-circuit boards, parts thereon, and video displays if equipment or parts are damaged or destroyed due to failure of following instructions.

WARNING — Players and/or technicians can be killed or injured if instructions are not followed.

CONTENTS

1 Installation

How to Use This Manual	1-1
Cabinet Equipment Requirements	1-2
Tools Required.....	1-2
Inspecting the Kit	1-5
Preparing the Cabinet for the Kit Installation	1-5
Assembling the Control Panel.....	1-5
Connecting the JAMMA Harness.....	1-6
Installing the Knuckle Bash Game PCB	1-7
Installing the Bezel, Decals, Labels, and Attraction Assembly	1-7
Adjusting the Volume	1-8
Setting the Coin and Game Options.....	1-8
Maximizing Earnings	1-8
Game Play.....	1-8

2 Self-Test and Troubleshooting

Introduction	2-1
Entering and Exiting the Self-Test	2-2
Select Test Screen	2-2
Input Check (Switch Test)	2-2
DIPSW (DIP Switch) Display	2-3
Sound Check Screen.....	2-4
Troubleshooting.....	2-4
Removing and Replacing the Joystick Controls	2-4

3 Parts Illustrations

See the List of Illustrations that follows.

4 Schematic Diagrams

See the List of Illustrations that follows.

ILLUSTRATIONS

Figure 1-1	Installed Kit Parts.....	1-3
Figure 1-2	Locations of Control Panel Holes to be Drilled.....	1-6
Figure 2-1	Select Test Screen	2-2
Figure 2-2	Input Check Screen	2-2
Figure 2-3	DIP Switch Display.....	2-3
Figure 2-4	Sound Check Screen.....	2-4
Figure 3-1	Parts for Knuckle Bash Universal Kit ...	3-2
Figure 3-2	Joystick Assembly	3-3
Figure 3-3	Knuckle Bash Game PCB Assembly...	3-4
Figure 3-4	JAMMA Filter PCB Assembly.....	3-5
Figures 4-1 through 4-8:	Knuckle Bash Game PCB Schematic Diagram, as follows:	
Figure 4-1	Circuit Overview Diagram.....	4-2
Figure 4-2	Graphics CPU.....	4-3
Figure 4-3	Graphics Control Unit	4-4
Figure 4-4	Sound and I/O Processor.....	4-5
Figure 4-5	Vertical Line-Counter and Audio Amplifier	4-6
Figure 4-6	FM and ADPCM Sound Generation....	4-7
Figure 4-7	Color Palette Look-Up and Video Out ..	4-8
Figure 4-8	JAMMA and I/O Interface	4-9
Figure 4-9	JAMMA Filter PCB Schematic Diagram	4-10

TABLES

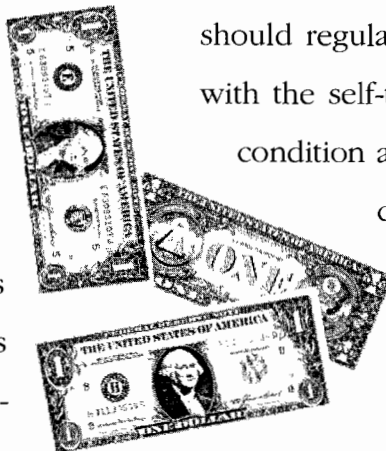
Table 1-1	Equipment Requirements	1-2
Table 1-2	Contents of Knuckle Bash Kit.....	1-2
Table 1-3	JAMMA Pin and Wire Connections	1-4
Table 2-1	DIP Switch 1 Settings.....	2-3
Table 2-2	DIP Switch 2 Settings.....	2-4
Table 2-3	DIP Switch 3 Settings.....	2-4
Table 2-4	Troubleshooting Table.....	2-5
Table 2-5	RAM and ROM Error Messages	2-6

Installation

HOW TO USE THIS MANUAL

THE KNUCKLE BASH™ conversion kit is a two-player game for a standard upright cabinet. ❖ This manual provides information for installing, testing, and troubleshooting the Knuckle Bash™ conversion kit. ❖ Chapter 1 describes how to install the Knuckle Bash kit in your cabinet. This chapter also describes game play. ❖ Chapter 2 contains self-test procedures and a trouble-

shooting table. The self-test is important in the Knuckle Bash game. You can troubleshoot the PC boards, main circuits, and controls using the screens in the self-test. You should regularly test the boards and controls with the self-test to keep your game in peak condition and at top earnings. ❖ Chapter 3 contains the kit parts illustrations. ❖ Chapter 4 contains the schematics for the Knuckle Bash game PCB.



WARNING

To avoid electrical shock, unplug the cabinet while installing the kit. After installation, plug the game only into a grounded 3-wire outlet.

Cabinet Equipment Requirements

Table 1-1 lists the equipment required in the cabinet into which you are installing the Knuckle Bash kit.

CAUTION

Do not unplug or plug in the Knuckle Bash game printed-circuit board (PCB) edge connector while the power is on. You could seriously damage the PCB.

Tools Required

- Drill with a 1/2-inch and 5/16-inch drill bits
- Phillips screwdriver
- Flat-blade screwdriver
- Socket wrench set and ratchet
- 5/32" hex wrench

- Wire cutters and strippers
- Straight edge
- Squeegee
- X-ACTO™ knife
- Insulated wire connectors (if you are installing a new JAMMA harness)
- Carbon paper
- Saber saw
- File
- Bandsaw
- Tape or glue

Equipment	Specification
Video Display	Color RGB monitor Separate positive horizontal and vertical sync or negative composite sync Horizontal mounting Horizontal frequency: 15.750 KHz Vertical frequency: 60 Hz Video input: 1V to 3V peak-to-peak positive polarity
Control Panel	Metal only
Speaker	8 Ω, 10 W
Coin Counter	+5 VDC or +12 VDC
Power Cord	Three-conductor with ground
Power Supply	+5 VDC ± 0.25V @ 5.0 amps minimum +12 VDC @ 1.0 amp -5 VDC @ 1.0 amp (optional)

Table 1-1 Equipment Requirements

Part No.	Description
72-6608S	#6 x 1/2"-Long, Type AB, Pan-Head, Cross-Recessed Screws (4)
75-5112B	#10-24 x 3/4"-Long Black Carriage Bolts (12)
038158-01	Product I.D. Label
039450-01	FCC Compliance Label
042452-01	FBI Warning Label
051656-01	Control Panel Cover
051500-01	Control Panel Decal
051498-01	Side Panel Decals (2)
051499-01	Attraction-Panel Film
051501-01	Monitor Bezel
051678-01	Set of Pushbutton Identification Labels for Control Panel
051679-01	Game Instructions Label
141026-003	.4"-Inside-Diameter Ferrite Split Beads (4)
160044-001	Snap-Action Switches (6)
171099-001	8-Position NO/NC Gold-Contact Black Joystick Control (2)
175014-1040	#10 Flat Washers (12)
177026-0040	#10-24 Zinc Nut/Washer Assemblies (12)
178237-001	Red Button Assemblies (6)
178373-0108	.5" Straight PCB Standoffs, w/Adhesive (2)
A047292-01	JAMMA Filter Board Assy.
155034-001	Knuckle Bash Kit Game PC Board Assy. (includes .75" screw-down standoffs)
TM-386	Knuckle Bash Kit Installation Instructions (with control panel templates)

*Packaging materials are not listed. All parts are a quantity of 1, except as noted in parentheses.

Table 1-2 Contents of Knuckle Bash Kit

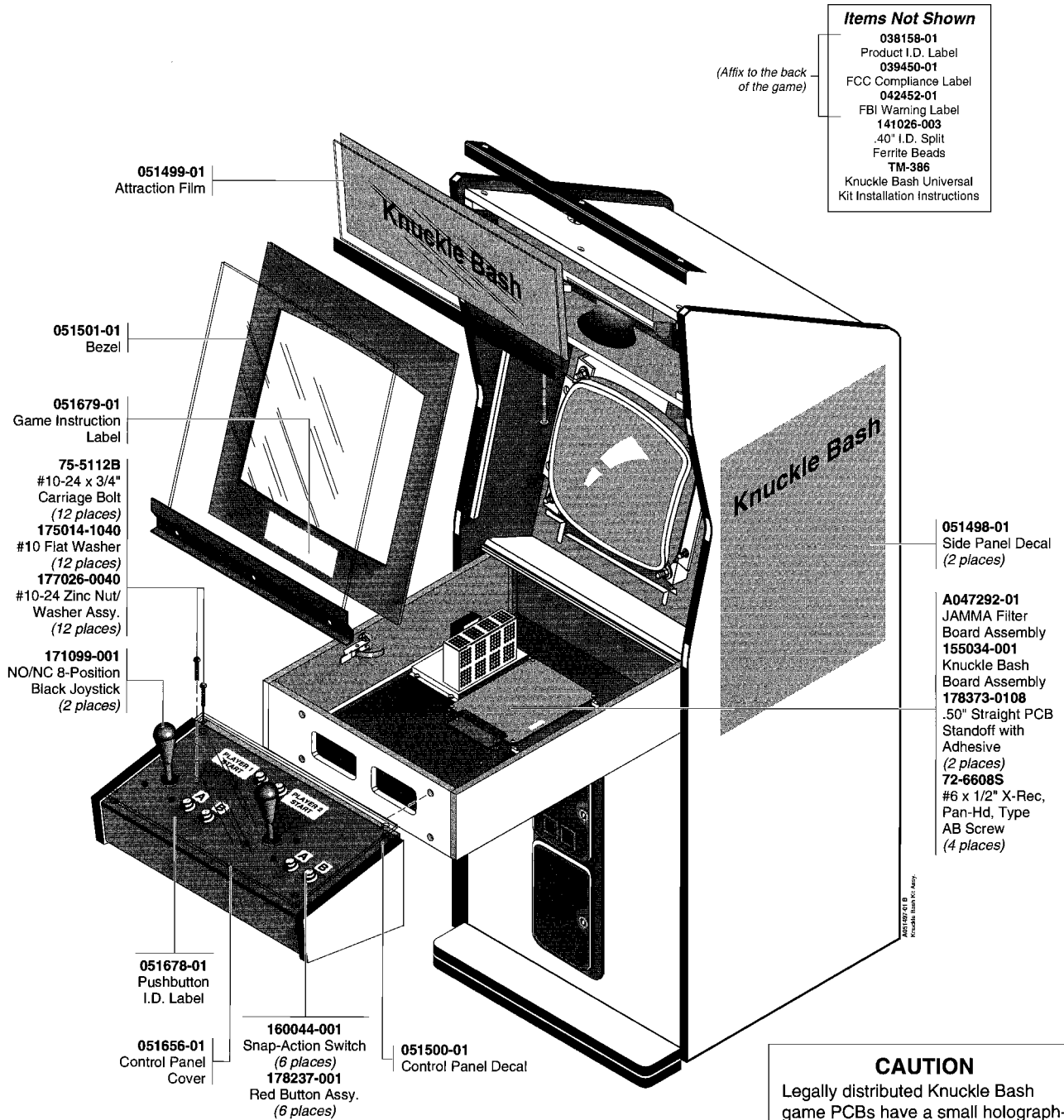


Figure 1-1 Installed Kit Parts

Solder Side

Component Side

Color ¹	Signal	Pin	Pin	Signal	Color ¹
Brown ²	POWER GND	A	1	POWER GND	Brown ²
Brown ²	POWER GND	B	2	POWER GND	Brown ²
Red ³	+5V DC	C	3	+5V DC	Red ³
Red ³	+5V DC	D	4	+5V DC	Red ³
Orange	Not Used	E	5	-5V DC is not used	Orange
Yellow ⁴	+12V DC	F	6	+12V DC	Yellow ⁴
—	Key	H	7	Key	—
Violet/White ⁵	COIN CTR 2	J	8	COIN CTR 1	Violet/White ⁶
—	Not Used	K	9	Not Used	—
White	SPKR -	L	10	SPKR +	Brown
—	Not Used	M	11	Not Used	—
Green	VIDEO GREEN	N	12	VIDEO RED	Red
Brown	VIDEO SYNC	P	13	VIDEO BLUE	Blue
—	Not Used	R	14	VIDEO GND	Black
—	Not Used	S	15	SELF-TEST	White ⁷
Orange	COIN SW2	T	16	COIN SW1	Yellow
—	PLYR2 START	U	17	PLYR1 START	White/Black
Yellow/Brown	PLYR 2 UP	V	18	PLYR 1 UP	White/Brown
Yellow/Red	PLYR 2 DOWN	W	19	PLYR 1 DOWN	White/Red
Yellow/Orange	PLYR 2 LEFT	X	20	PLYR 1 LEFT	White/Orange
Yellow/White	PLYR 2 RIGHT	Y	21	PLYR 1 RIGHT	Yellow
Yellow/Green	PLYR 2 BUTTON A	Z	22	PLYR 1 BUTTON A	White/Green
Yellow/Blue	PLYR 2 BUTTON B	a	23	PLYR 1 BUTTON B	White/Blue
Yellow/Violet	Not Used	b	24	Not Used	White/Violet
—	Not Used	c	25	Not Used	—
—	Not Used	d	26	Not Used	—
Black/White	SWITCH GND	e	27	SWITCH GND	Black/White
Black/White	SWITCH GND	f	28	SWITCH GND	Black/White

Footnotes

¹The colors listed are for reference only. They are the colors used on the JAMMA harness available from Atari.

²Connect to the 5V GND (RTN) terminal on the power supply. However, if you have 12V GND, connect *one* of the wires at pin 1, 2, A, or B to the 12V GND terminal.

³Connect to the +5V terminal on the power supply. However, if your power supply has a + Sense terminal, connect to the + Sense.

⁴Connect to the +12V terminal of the power supply. If your coin counter(s) require 12V, also connect to the + side of the coin counter(s).

⁵If you want to install a second coin counter, connect this wire to one side of the right 12V coin counter. *Note: Do not use 24V counters.* Connect the + side to +5V or +12V on the power supply, as appropriate.

⁶Connect this wire to one side of the left 12V coin counter. *Note: Do not use 24V counters.* Connect the + side to +5V or +12V on the power supply, as appropriate.

⁷Use this wire if you want an external self-test switch. However, the kit already has a self-test switch on the game PCB. (If you connect an external self-test switch, turn off the switch on the PCB. Connect the wire to the N.O. terminal on the external self-test switch. Connect the common terminal of the switch to a GND wire.)

Table 1-3 JAMMA Pin and Wire Connections

Inspecting the Kit

Check to see that you have all the parts listed in the kit parts list in Table 1-2. If any part is missing or damaged, contact your distributor with the Knuckle Bash kit serial number, part number, and description of the missing or damaged parts, and date received.

Preparing the Cabinet for the Kit Installation

WARNING

To avoid electrical shock, unplug the cabinet while installing the kit. After installation, plug the game only into a grounded 3-wire outlet.

Figure 1-1 shows almost all kit parts installed in a typical cabinet. Use this illustration as a guide while you install the parts.

1. Turn off power to the game, and unplug the power cord.
2. Remove the following from the cabinet:
 - Existing PCBs
 - Game harness, if it is not Japan Amusement Machinery Manufacturers Association (JAMMA)-compatible
 - Control panel decals, labels, and controls
 - Side decals, graphics, and adhesive. If the cabinet sides are damaged, repair them before putting on the new decals.
 - Video display (monitor) shield, display bezel, attraction shield, and marquee.
3. Wipe down and vacuum the cabinet. Paint the cabinet, if required.

Assembling the Control Panel

Parts Needed for this Kit

To assemble the control panel, you need to decide on where to cut the control panel holes. Refer to Figure 1-2. Create a template sheet from that illustration. You will also need the following parts from the kit:

- Clear cover for the control panel
- Control panel decal
- Six red button assemblies
- Six snap-action switches

- Six control-panel labels (*Player 1 Start, Player 2 Start*, two *A* and two *B* labels).
- Two joystick controls
- Eight #10-24 x 3/4"-long black carriage bolts, flat washers, and nut/washer assemblies for the two joysticks
- Four #10-24 x 3/4"-long black carriage bolts, flat washers, and nut/washer assemblies for the corners of the control panel cover

Installing the Parts

1. Using carbon paper, transfer the joystick mounting pattern from the template to the control panel. Save the template.
2. Drill four 1/4" holes in the metal control panel for each joystick's mounting bolts.
3. Using a saber saw, carefully cut out the large holes for the joysticks. Deburr the sharp edges with a file.
4. Lay the plexiglass cover over the top of the control panel and mark the outside shape of the panel on the plastic. Also mark the button holes as close as possible to the locations shown on the template.

Lastly, mark the positions of the four holes that will be used for securing the cover to the control panel. These four holes can be placed anywhere near the corners — wherever space permits.
5. Using a bandsaw, cut the control panel cover to its correct outside shape.

WARNING

Wear safety glasses when drilling the plastic control panel cover. Use care to avoid shattering or chipping the plastic.

6. Tape or glue the template to the plexiglass cover. To start the saber saw cut, drill a 1/2" hole inside the joystick holes and the button holes.
7. Saw out the two large joystick holes and the button holes.
8. Drill the four 5/16" holes that will be used to mount the cover to the control panel and the 5/16" holes to mount the joysticks.
9. To prevent injury, carefully deburr all the edges of the plexiglass cover.
10. Install the control panel decal on the control panel. Use a sharp X-ACTO knife to trim the outside edge and to cut out the holes for the controls.

11. Punch out the rectangular decals from the sheet and mount them beside each of the top two button holes: *Player 1 Start* on the left, and *Player 2 Start* on the right.
12. Punch out the small square decals from the sheet and mount them above the button holes: from left to right they should be A, B, A, B.
13. Install the cover on the control panel with the four 3/4"-long carriage bolts, washers, and locknuts.
14. Install the joysticks using the 3/4"-long carriage bolts and #10-24 nut/washer assemblies.
15. Install the button assemblies as shown in Figure 1-1.

For maintenance and servicing information on the joystick controls, refer to Chapter 3 of this manual.

Connecting the JAMMA Harness

1. If your game cabinet does not already have a JAMMA harness, install a JAMMA harness in the cabinet. To purchase a JAMMA harness, contact the Atari Games Customer Service office closest to you.

2. Install the split beads on the harness as close to the PCB edge connector as possible. Hold the beads on the harness with the tie wraps included in the kit.

CAUTION

You must install the split beads and the JAMMA Filter PCB on the JAMMA harness to meet FCC requirements. (These parts are included in the kit.)

3. Using Table 1-3 for wiring information, connect the JAMMA harness to existing component harnesses. Use crimp splices or butt soldering.

WARNING

Do not simply tie the wires together. If you do, you could cause intermittent problems, loose connections, oxidation, or a fire.

Connecting Power Wires

1. Connect the wires on the JAMMA harness to the wires for the power supply, as shown in Table 1-3.

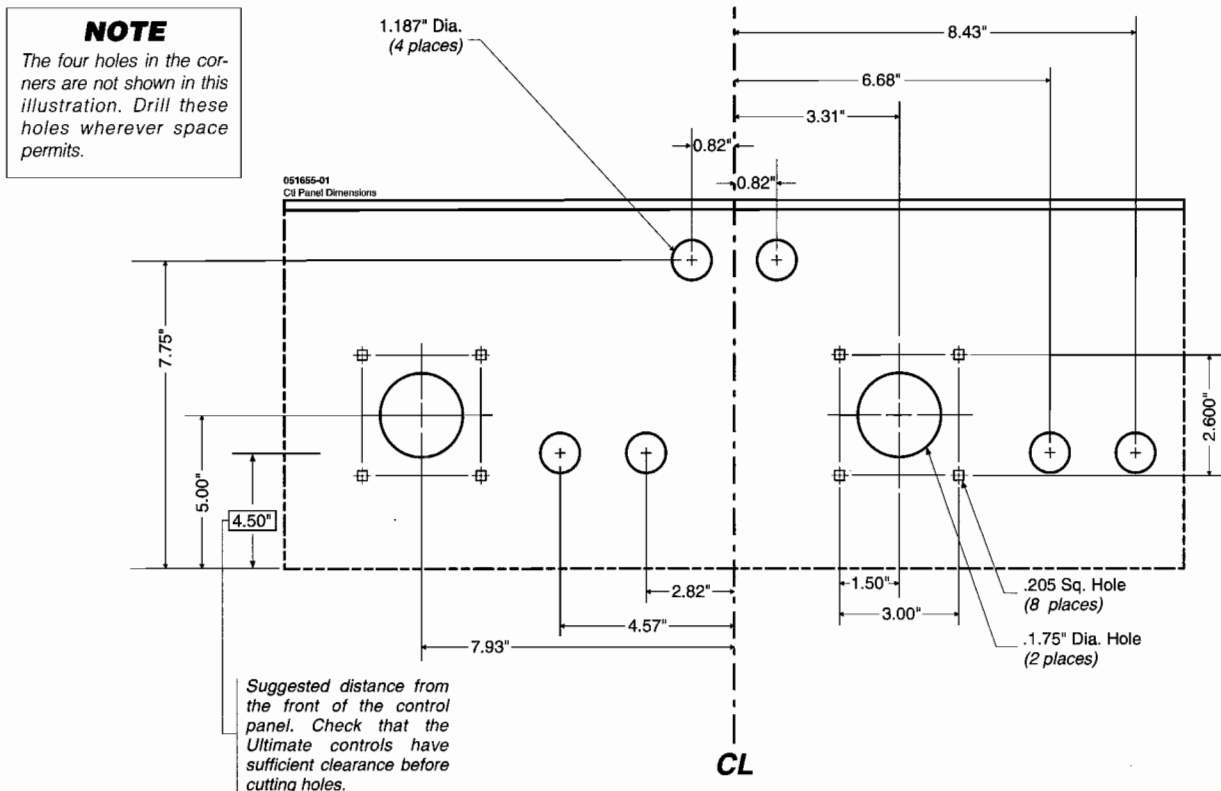


Figure 1-2 Locations of Control Panel Holes to be Drilled

The Knuckle Bash kit requires +5V and +12V. The -5V is not needed and should *not* be used. Tie off any other voltage wires on the power supply besides +5V, -5V, and +12V.

There is more than one wire for each voltage in the JAMMA harness. Use more than one wire for each voltage (connecting them as described in Table 1-3) so that the power wiring does not overload and burn.

Connecting Video Display Wires

NOTE

The JAMMA harness provides only negative composite sync.

Connect the wires designated for the red, green and blue video guns along with the sync and ground wires, according to Table 1-3.

Connecting Coin Door Wires

1. Connect the wires on the JAMMA harness to the coin switches and meter according to Table 1-3.
2. Connect one terminal of the door lamps to one of the BK/W wires. Connect the other terminal of the door lamps to the R wire supplying +5V.

NOTE

Do not use -5V for the coin door lamps.

Some games have separate power supply outputs for the coin door lamps. If you choose to use these outputs, make sure you connect both terminals of each lamp to the terminals on the power supply.

Connecting the Control Wires

Connect the joystick harness and the button harnesses to the JAMMA harness using crimp splices or butt soldering, according to the information in Tables 1-3 and 1-4.

Grounding the Cabinet

Find the ground lead (green) of the 115V input power line. Connect this lead in daisy-chain fashion to a bare metal part of the coin door, the control panel, the video display, and the power supply. This AC ground must be of #18 AWG wire or larger.

WARNING

For the safety of players, you must connect the green ground wire as indicated above.

Checking the JAMMA Connections

Before plugging in the game PCB, turn on the power to the game, and check +5 Volts on pins 3, 4, C, and D of the JAMMA connector; +12 Volts on pins F and 6; and -5 Volts on pins E and 5.

Check that the video display and the attraction lamp have power. Now turn off the power to the game.

Installing the Knuckle Bash Game PCB

1. After you have checked the power on the JAMMA connector (above), install the Knuckle Bash game board set in the cabinet. Use the four #6 x 1/2"-long screws in the kit to mount the four nylon standoffs. These standoffs support the Knuckle Bash game board.
2. Plug the JAMMA Filter PCB into the game board. Install the nylon standoffs to support the Filter PCB.
3. Connect the JAMMA harness connector to the Filter PCB.
4. Secure the JAMMA harness away from the PCB with cable ties.
5. Turn on the power to the game. Check that the game PCB functions. If a video picture is not present, see Chapter 3.

Installing the Bezel, Decals, Labels, and Attraction Assembly

The bezel, decals, labels, and attraction assembly are shown assembled in a cabinet in Figure 1-1.

Installing the Display Bezel

Find the cardboard display bezel in the kit. This bezel can accommodate both 19-inch and 25-inch video displays. Follow the instructions on the back of the bezel, and cut the hole and outside edges as required. If the bezel is missing from your kit, you can use a plain black bezel in the cabinet. Then find the game instruc-

tions label in the kit, and adhere that label to the bottom center of the bezel.

Installing the Product ID and FCC Label

Place the product ID label (part no. 038158-01) and FCC compliance label (part no. 039450-01) on the back of the cabinet.

Installing the Side Panel Decals

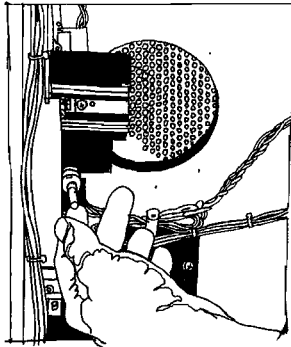
Find the side panel decals in the kit. Wet the left and right side panels of the cabinet with slightly soapy water. Then position the decals as shown in Figure 1-1. Remove any wrinkles in the artwork using a squeegee. Allow the sides to dry.

Installing the Attraction Assembly

Find the Knuckle Bash attraction film in the kit (the attraction shield should be reused from your cabinet). Using the existing shield as a template, cut the film to size, if necessary. Install them on the cabinet as shown in Figure 1-1.

Adjusting the Volume

This game has a volume control potentiometer on the game printed-circuit board. To adjust the volume, turn the white knob located near the PCB's edge connector.



Setting the Coin and Game Options

Set the coin and game options in the self-test. See Chapter 2 for information about the option settings.

Maximizing Earnings

For maximum earnings, regularly maintain your Knuckle Bash game following the instructions in Table 2-4, in Chapter 2.

When you set up the game and when you collect money, perform the Input Check and Sound Check in the self-test.

Game Play

This section describes the theme of the Knuckle Bash game and the game play features.

Introduction

Join Clash, Dice and Devo as they make their stand against wrestling's underworld! This is the tale of how these young wrestlers saved the sport from evil and corruption!

The Mad Bull Group is a corrupt wrestling organization that profits while draining the purity of the sport. Help the Knuckle Bash team overpower evil and convert the Mad Bulls to their side! Our young wrestlers know how millions of young fans look up to them as role models. It's for them they must *take a stand!*

In a Chicago hotel, a secret meeting has been arranged. The heroes decide to obtain the services of a powerful master of NINPOW. His name is "Hiyate". He resides in Hong Kong and is known to be a skillful and cunning fighter.

The Mad Bulls want him, too, and will stop at nothing. The heroes can't let this happen. Even if it means...

Unfortunately, even our heroes were once members of the Bull Group. But once the Bulls learned our heroes didn't believe in their ways, they were labeled as traitors.

Our young wrestlers journey to BATTLE KINGDOM, headquarters of the Bull Group. It's rumored that one of them wants out of the organization. It seems he doesn't agree with their methods...

After numerous battles, our heroes succeeded in destroying the Bull Group. The world is free of their evil ways. The story of our heroes has become legendary. Children can again look up to and dream of becoming wrestling heroes themselves!

What a Knuckle Bash it was!

Game Characters

- Clash — The one member of our heroes who hides his true identity behind a mask. Possessing great strength and the famous "Flaming Tailspin," he's sure to heat up the action!
- Dice — A real fan of Rock and Roll, Dice takes his electric guitar everywhere he goes. It really comes in handy when he battles with the Mad Bulls. Don't come a-knockin' when this man's a-rockin'!
- Devo — The suave guy of the trio. His good looks have resulted in many a movie offer. Too bad, Hollywood, Devo's got a job to do! His "Blue Wave" throw will surely wash up those Bulls.

Game Play Description

Knuckle Bash is a one- or two-player simultaneous fighting game. It's a fun, easy-to-play fighting game with colorful graphics. In the game, players fight to save the sport of wrestling from evil criminals! Players select from three colorful characters. As enemies are defeated and converted, the choice expands to five. Our band of heroes travels by motorcycle to brawl with the Bulls in hotels, shipping docks, and even football stadiums!

To finish the game, players must battle their way through ten stages. Players select one of two stories to

start. No matter what route players choose, they must fight the monstrous Pig Man and the Evil Kabuki in the end. Mixed into the action are Bonus Rounds where players pound on the buttons to decide who throws the knockout blow!

Players each use a joystick and two buttons for an assortment of moves, including an impressive signature "Big Strike Home" move.

Help our heroes save the wrestling world from corruption and evil!

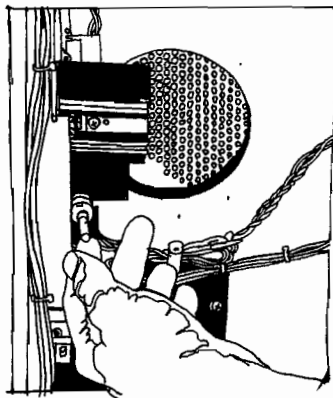
N O T E S

Self-Test and Troubleshooting

INTRODUCTION

THIS CHAPTER contains a description of the self-test and two troubleshooting tables for your Knuckle

Bash™ game. Use the self-test procedure to check the condition of the game circuitry and controls. You will see the self-test information on the video display and hear the sound test information through the speakers. You do not need any



additional equipment to perform the self-test.

❖ You should perform the self-test when you first set up the game, each time you collect the

money, or when you suspect game failure. ❖ This chapter shows the screens in the self-test and explains each of the tests. The screens and explanations are arranged in the order they appear in the self-test.

Entering and Exiting the Self-Test

To enter the self-test, push switch 3 on DIP Switch 1 to the on position (located on the game PCB). See Figure 3-3 of this manual, which highlights the locations of DIP Switches 1 and 2. Exit the self-test by returning this switch to the off position.

Select Test Screen

Use this screen to choose which of the three screens you want to see (see Figure 2-1). Move up and down the list by moving the left joystick. After the arrow indicates your selected screen, press A or B button on the Player 1 (left) side.

The Select Test screen also displays two test patterns for checking the color and convergence of your video display. Their uses are explained below.

Color Test

The color blocks in the center should be four bands (red, green, blue, and black/white from top to bottom), each with a color scale from bright to dark, left to right. If the screen does not match this description, adjust the video display as described in the video display manual.

Convergence Test

The convergence test pattern has a white grid on a black background. Check the following:

- The grid lines should be straight within 3 mm, and the lines should not have excessive pincushion or barrel distortion.
- The convergence of the lines on the white cross-hatch horizontal and vertical lines should be within 2 mm.

If these screens do not meet these criteria, adjust the video display as described in the video display manual.

Returning to the Select Test Screen

You can exit from any of the three screens and return to the Select Test screen as follows:

- Change the toggle 3, DIP switch 1, back to off and on again, or
- Turn the game power switch off, then on again.

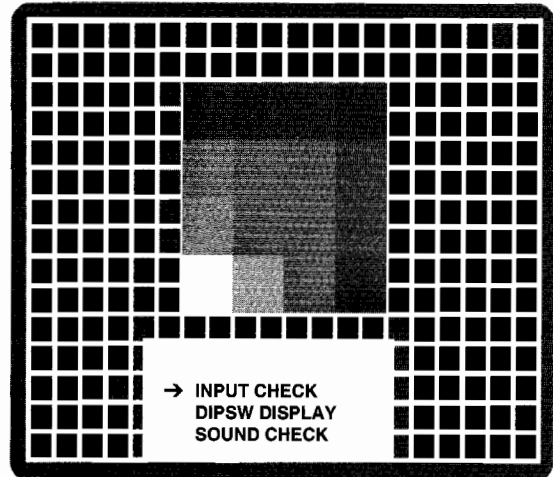


Figure 2-1 Select Test Screen

Input Check (Switch Test)

Use this screen to check all the coin switches, control panel switches, and joystick switches in this game (see Figure 2-2). This screen also displays the status of the sound circuitry, the RAM and the ROM.

To check the functioning of each switch, activate it and watch the corresponding *Off* message change to *On*.

NOTE

The Service switch message will be activated if you connect a convenience self-test switch to Pin 15 of the JAMMA edge connector.

If the *On* and *Off* messages do not appear correctly, check the harness connections, switches, and joystick controls.

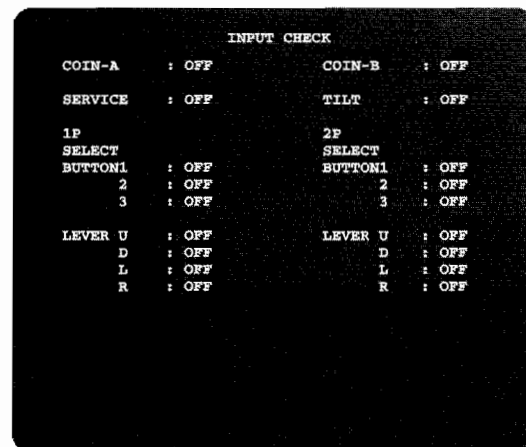


Figure 2-2 Input Check Screen

Option	Switch Settings		Result	
Discount to Continue	1 Off		No discount ✓	
	1 On		Discount	
Picture Orientation	2 Off		Normal ✓	
	2 On		Reversed picture	
Self-Test (Function Check)	3 Off		Normal game play ✓	
	3 On		Test mode	
Sound in Attract Mode	4 Off		Sound is on ✓	
	4 On		No sound during attract mode	
Game Cost in U.S.	5 Off	6 Off	1 coin for 1 play ✓	For SW1 or left mechanism
	5 On	6 Off	1 coin for 2 plays	
	5 Off	6 On	2 coins for 1 play	
	5 On	6 On	2 coins for 3 plays	
Game Cost in U.S.	7 Off	8 Off	1 coin for 1 play ✓	For SW2 or right mechanism
	7 On	8 Off	1 coin for 2 plays	
	7 Off	8 On	2 coins for 1 play	
	7 On	8 On	2 coins for 3 plays	
<i>Alternate:</i>				
Game Cost in Europe	5 Off	6 Off	1 coin for 1 play ✓	For SW1 or left mechanism
	5 On	6 Off	2 coins for 1 play	
	5 Off	6 On	3 coins for 1 play	
	5 On	6 On	4 coins for 1 play	
Game Cost in Europe	7 Off	8 Off	1 coin for 2 plays ✓	For SW2 or right mechanism
	7 On	8 Off	1 coin for 3 plays	
	7 Off	8 On	1 coin for 4 plays	
	7 On	8 On	1 coin for 6 plays	

✓ Manufacturer's recommended settings. See Table 2-3 for details on how to enable either the U.S. or European coin settings.

Table 2-1 DIP Switch 1 Settings

DIPSW (DIP Switch) Display

Use this screen to see how all the dual-inline-package (DIP) switch toggles on the game PCB are set. You can view and change the coin and game options on this screen, shown in Figure 2-3. The coin and game option settings are explained in Tables 2-1, 2-2, and 2-3.

To change a setting, slide the appropriate toggle on the DIP switch to on or off. The screen will immediately display the change in status.

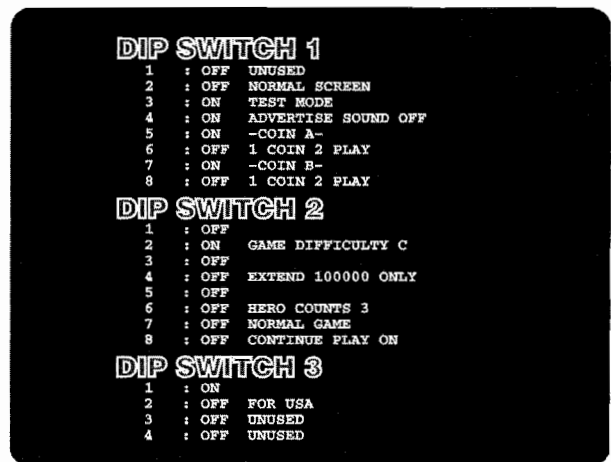


Figure 2-3 DIP Switch Display

Option	Switch Settings		Result
Game Difficulty	1 On	2 Off	A (Easy)
	1 Off	2 Off	B (Normal)
	1 Off	2 On	C (Difficult) ✓
	1 On	2 On	D (More difficult)
Extra Life Granted	3 Off	4 Off	At 100,000 and 400,000 points
	3 On	4 Off	At 100,000 points only
	3 Off	4 On	At 200,000 points only ✓
	3 On	4 On	No extra life granted
No. of Lives (Hero Counts)	5 On	6 On	1 life
	5 Off	6 Off	2 lives ✓
	5 Off	6 On	3 lives
	5 On	6 Off	4 lives
Game Mode	7 Off		Normal mode ✓
	7 On		No-death/stop mode
Continue Play	8 Off		Continues play at same level after inserting more coins ✓
	8 On		No game continuation

✓ *Manufacturer's recommended settings.*

Table 2-2 DIP Switch 2 Settings

Option	Switch Settings		Result
Coin Settings	1 On	2 Off	For U.S. coins. Install 0-ohm resistor into location JP4.
	1 Off	2 On	For European coins. Install 0-ohm resistor into location JP3.

Note: Switches 3 and 4 are unused.

Table 2-3 DIP Switch 3 Settings

Sound Check Screen

Use this screen to check the sound circuitry (see Figure 2-4). Play various sounds: if several of them are not audible, you may have a bad sound ROM or audio circuitry on this game board.

Pushing and releasing the left player joystick towards the right increments the sound number.; if you hold that joystick to the right, the software cycles through all sound numbers. To start playing a sound, press button A on the left side. To stop the sound, press button B.

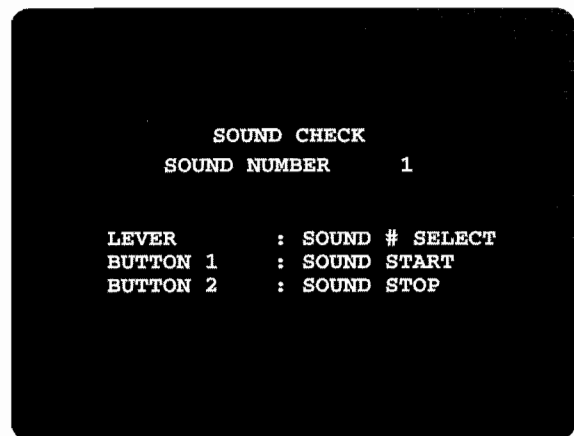


Figure 2-4 Sound Check Screen

Troubleshooting

Table 2-4 (troubleshooting) in this chapter can help you pinpoint problems in your game. This table lists possible sources of problems in various parts of the game.

Problem	Suggested Action
Coin Mechanism Problem	<ol style="list-style-type: none"> 1. Check the wiring to the coin switch and counter. 2. Test the coin switch with the sound test screen in the self-test.
Game Play Problem	<ol style="list-style-type: none"> 1. Check the harness and connectors. 2. Perform the self-test. 3. Check the voltage levels on the PCB.
Joystick Problems	<ol style="list-style-type: none"> 1. Has the joystick been lubricated? If not, lubricate it at the location shown in Figure 3-2. 2. Check the harnesses and connectors. 3. Check the switches on the joystick by using the Input Check screen in the self-test procedure. 4. If you took the control apart, have you reassembled it correctly? 5. Make sure all the parts on the control are in good repair. Repair or replace parts.
Sound Problem	<ol style="list-style-type: none"> 1. Is the speaker volume turned up? (Volume is adjusted on the game PCB.) 2. Check the voltage on the game PCB edge connector. 3. Check the wiring from the PCB to the speaker. 4. Check the voltage level to the PCB. 5. Replace the speaker.
Video Display Problem Screen is dark.	<ol style="list-style-type: none"> 1. Is the game plugged in? 2. Is the game turned on? 3. Are the connections good? 4. Is the line fuse good? 5. Is the display brightness turned up? 6. Are the edge connectors on the game PCB and JAMMA Filter PCB tightly connected? 7. Check all of the items below. If you answer <i>no</i> to any question, you have a problem with the video display, not with the game circuitry. See your video display service manual. <ol style="list-style-type: none"> a. Do you have power to the video display? b. Are the video display's filaments lit? c. Do you have high voltage to the video display? 8. Are the voltage levels to the video display PCB correct? (Power voltage is 100 VAC or 110 VAC, depending on the type of video display. Video signal voltage is 0.5 to 3.5 Volts.) 9. If the level is not correct, check the connectors and the harness.
Only a colored screen appears.	You probably have a serious RAM problem.
Display area wavers or is too small.	<ol style="list-style-type: none"> 1. Do you have correct power voltage to the video display PCB? 2. Do you have correct high voltage to the video display?
Picture is wavy.	<ol style="list-style-type: none"> 1. Is the monitor ground connected to the monitor? 2. Are the sync inputs connected properly?
Picture is upside down.	<p>Check DIP Switch 1, toggle 2, on the game PCB. This toggle should be in the off position for a normal screen.</p> <p>Another possibility is if you serviced the display, you may have connected the wires incorrectly. Switch the horizontal or vertical yoke wires on the display.</p>
Convergence, purity or color problems.	Use the screens in the self-test to adjust the video display. Use the adjustment procedures in your video display manual.
Picture is not centered.	Use the centering procedures in your video display manual.

Table 2-4 Troubleshooting Table

Message	Type of IC
Work RAM Err	Working RAM
Color RAM Err	Color RAM
Free RAM Err	Free RAM
A VRAM Err	A Video RAM
B VRAM Err	B Video RAM
C VRAM Err	C Video RAM
ROM Err	Program ROM
Sound Err	Color ROM

Table 2-5 RAM and ROM Error Messages

Removing and Replacing the Joystick Control

The joystick control is shown in Figure 3-2. If you want to repair the joystick control, disassemble it by removing it from the control panel. To repair the joystick, disassemble it by removing the retaining ring at the bottom of the shaft. To replace any of the four switches, remove the two screws that secure each switch.

Parts Illustrations

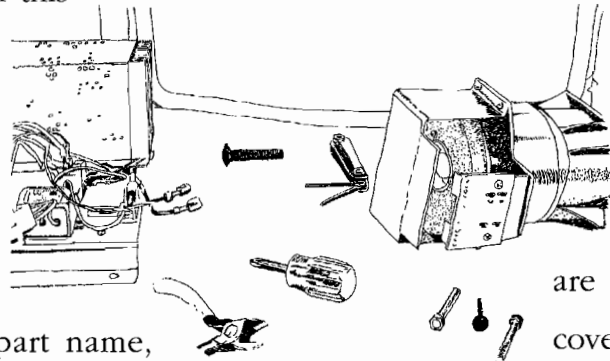
INTRODUCTION

THIS CHAPTER provides information you need to order replacement parts for your kit. All the common

hardware parts sold with this

kit, such as screws, nuts, washers, and so on, are included in these parts illustrations.

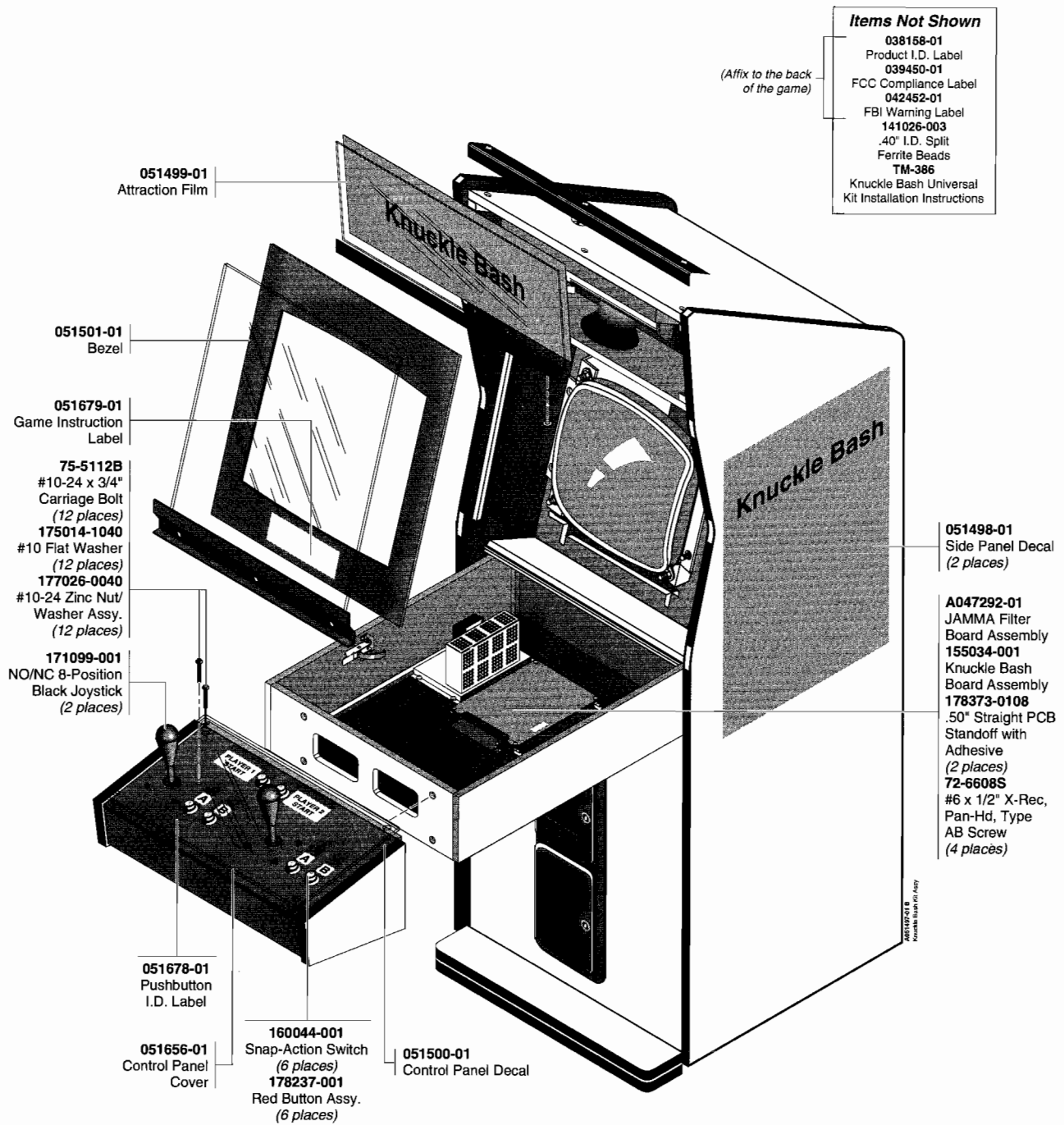
When you order parts, give the part number, part name,



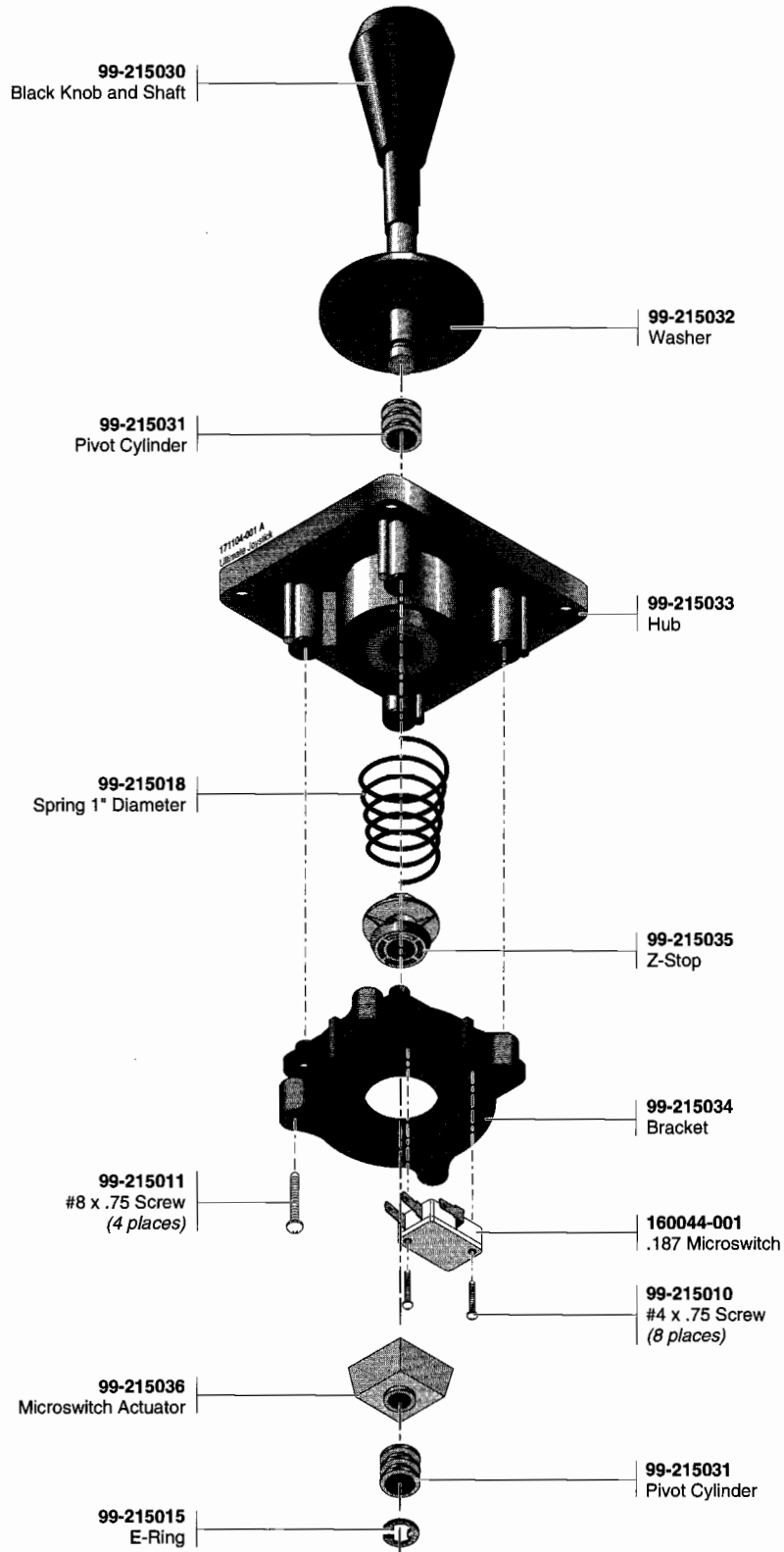
the number of this manual, and the serial number of your kit. ❖ With this information, we can fill your order rapidly and correctly.

We hope this will create less downtime and more profit from your games.

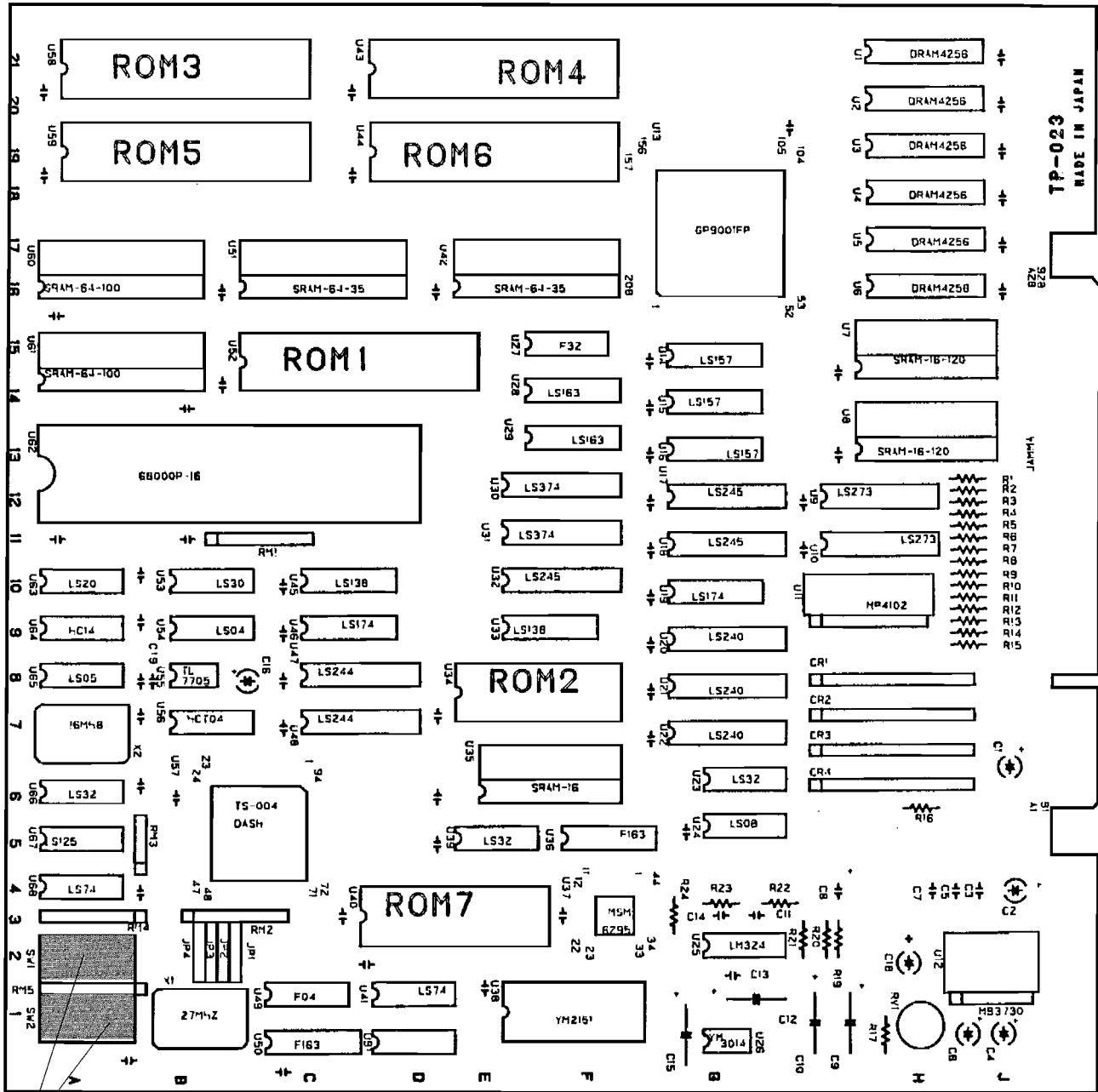
Atari Games Customer Service phone numbers are listed on the inside front cover of this manual.



**Figure 3-1 Parts of Knuckle Bash Universal Kit
A051497-01 C**

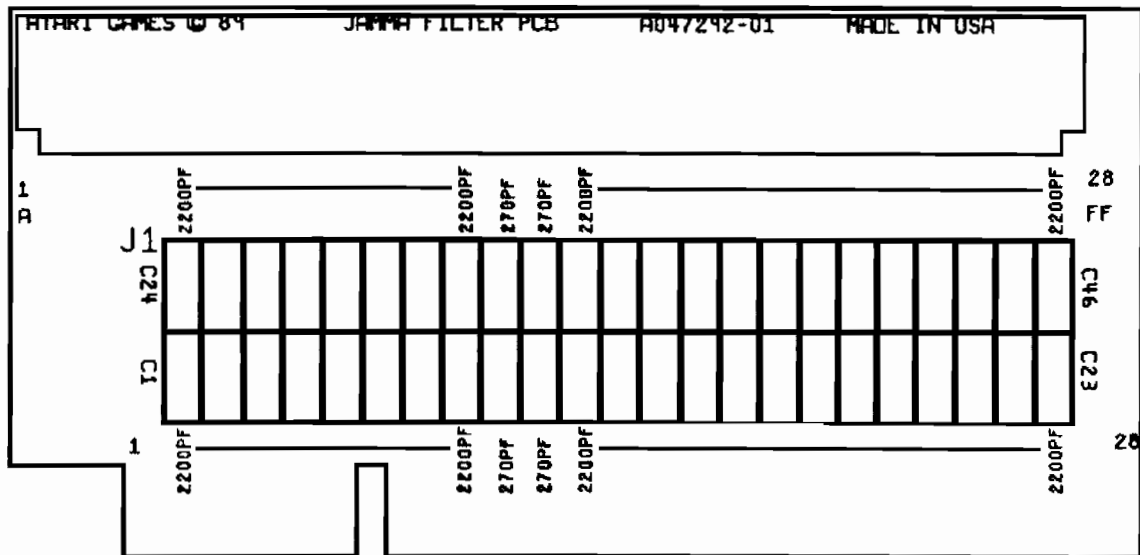


**Figure 3-2 Joystick Assembly
171099-001**



Are both DIP switch locations. Use for setting game and coin options.

Figure 3-3 Knuckle Bash Game PCB Assembly
155034-001



**Figure 3-4 JAMMA Filter PCB Assembly
A047292-01 B**

**JAMMA Filter PCB Assembly
Parts List**

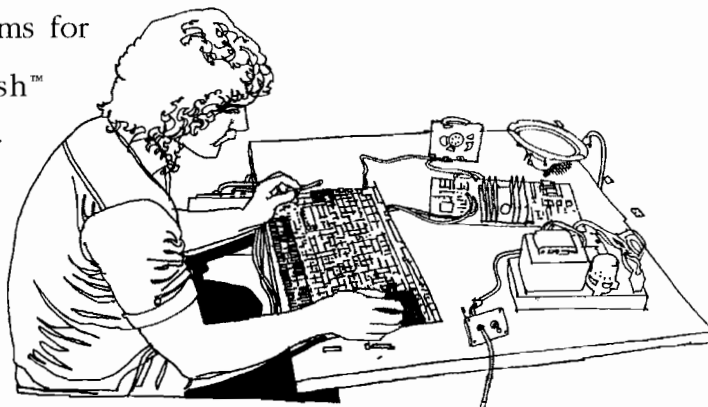
Designator	Description	Part No.	Designator	Description	Part No.
C1-8	2200 pF, 50V, 3-Pin EMI Filter Cap.	140006-222	C32, C33	270 pF, 50V, 3-Pin EMI Filter Cap.	140006-271
C9, C10	270 pF, 50V, 3-Pin EMI Filter Cap.	140006-271	C34-46	2200 pF, 50V, 3-Pin EMI Filter Cap.	140006-222
C11-31	2200 pF, 50V, 3-Pin EMI Filter Cap.	140006-222	J1	Connector, 56 Ckt., .156 Ctr, RT	179240-056

N O T E S

Schematic Diagrams

INTRODUCTION

THIS CHAPTER contains the schematic diagrams for your Knuckle Bash™ game PCB and JAMMA filter PCB. The game PCB and JAMMA filter PCB *assembly drawings* are illustrated in Chapter 3, Parts Illustrations.



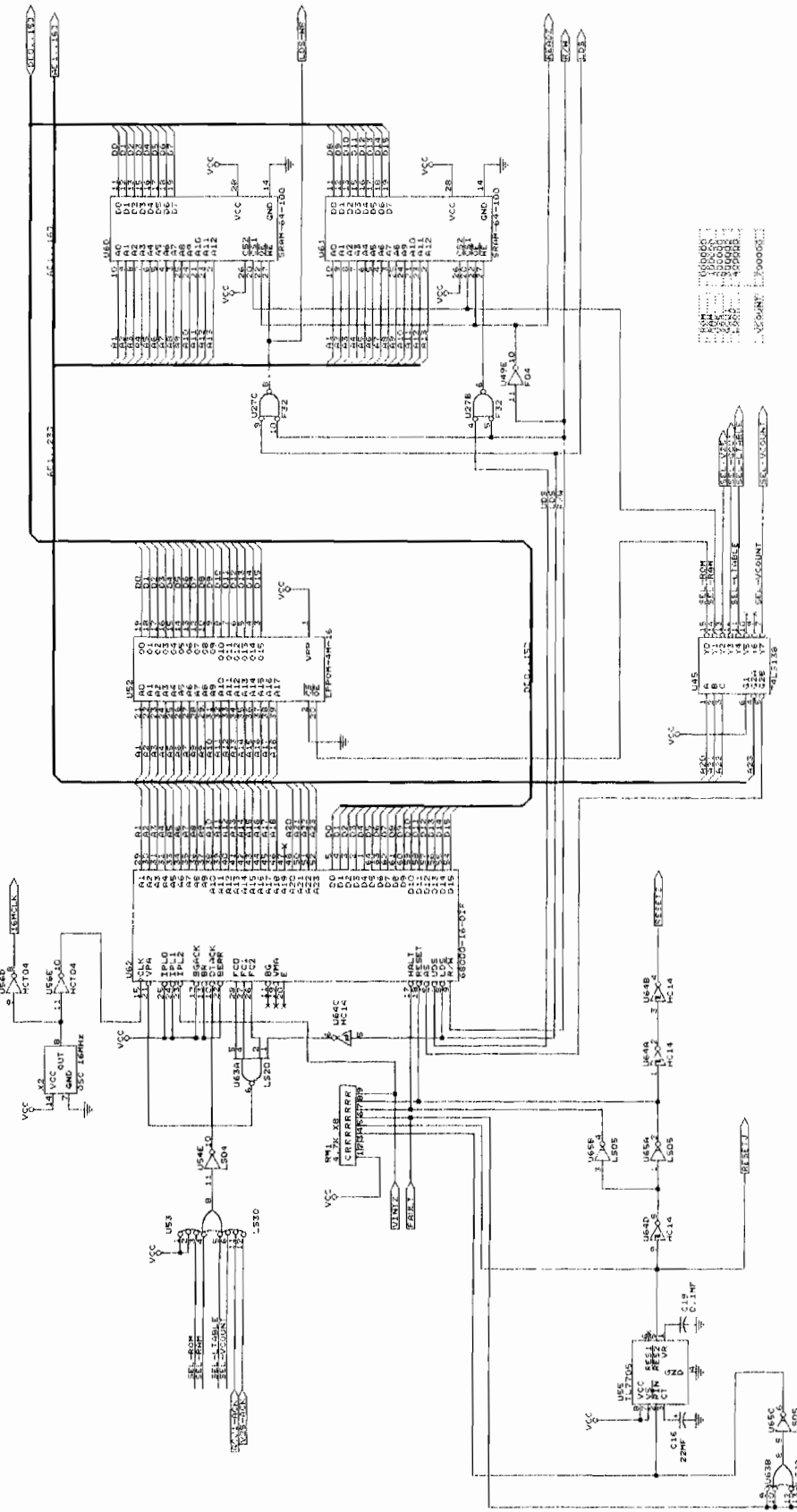


Figure 4-2 Knuckle Bash Game PCB Schematic Diagram

Graphics CPU

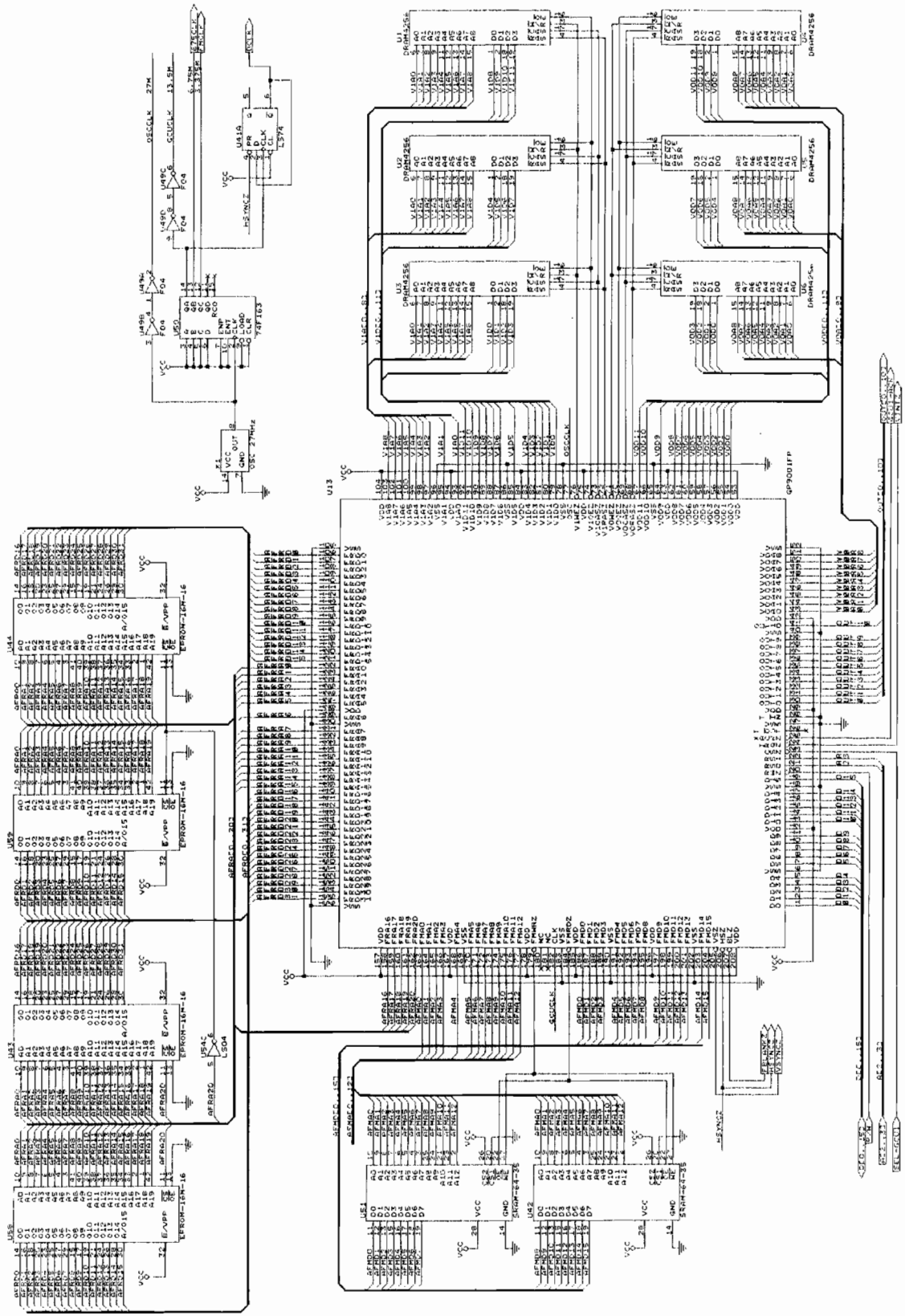


Figure 4-3 Knuckle Bash Game PCB Schematic Diagram
Graphics Control Unit

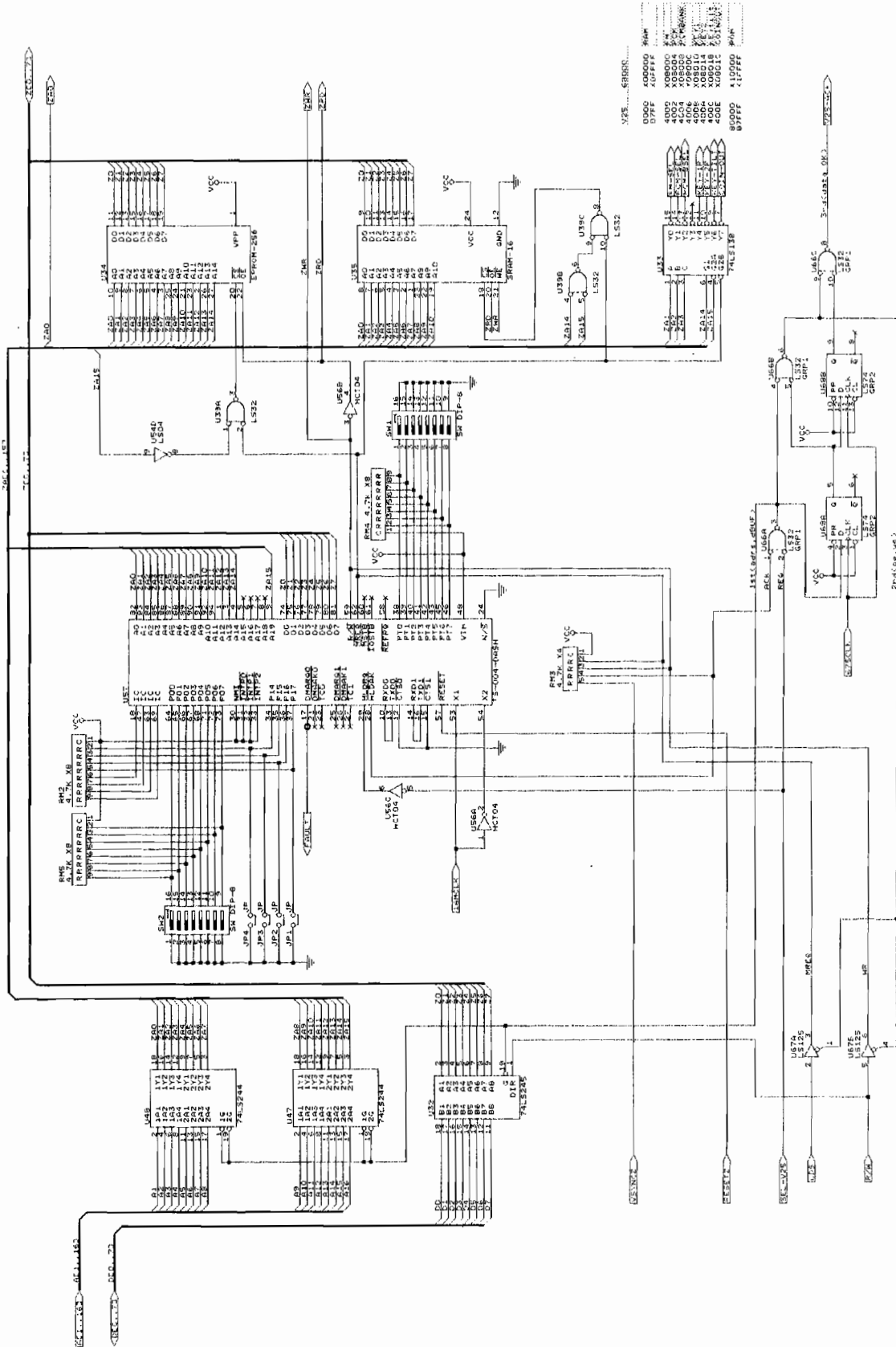


Figure 4-4 Knuckle Bash Game PCB Schematic Diagram
Sound and I/O Processor

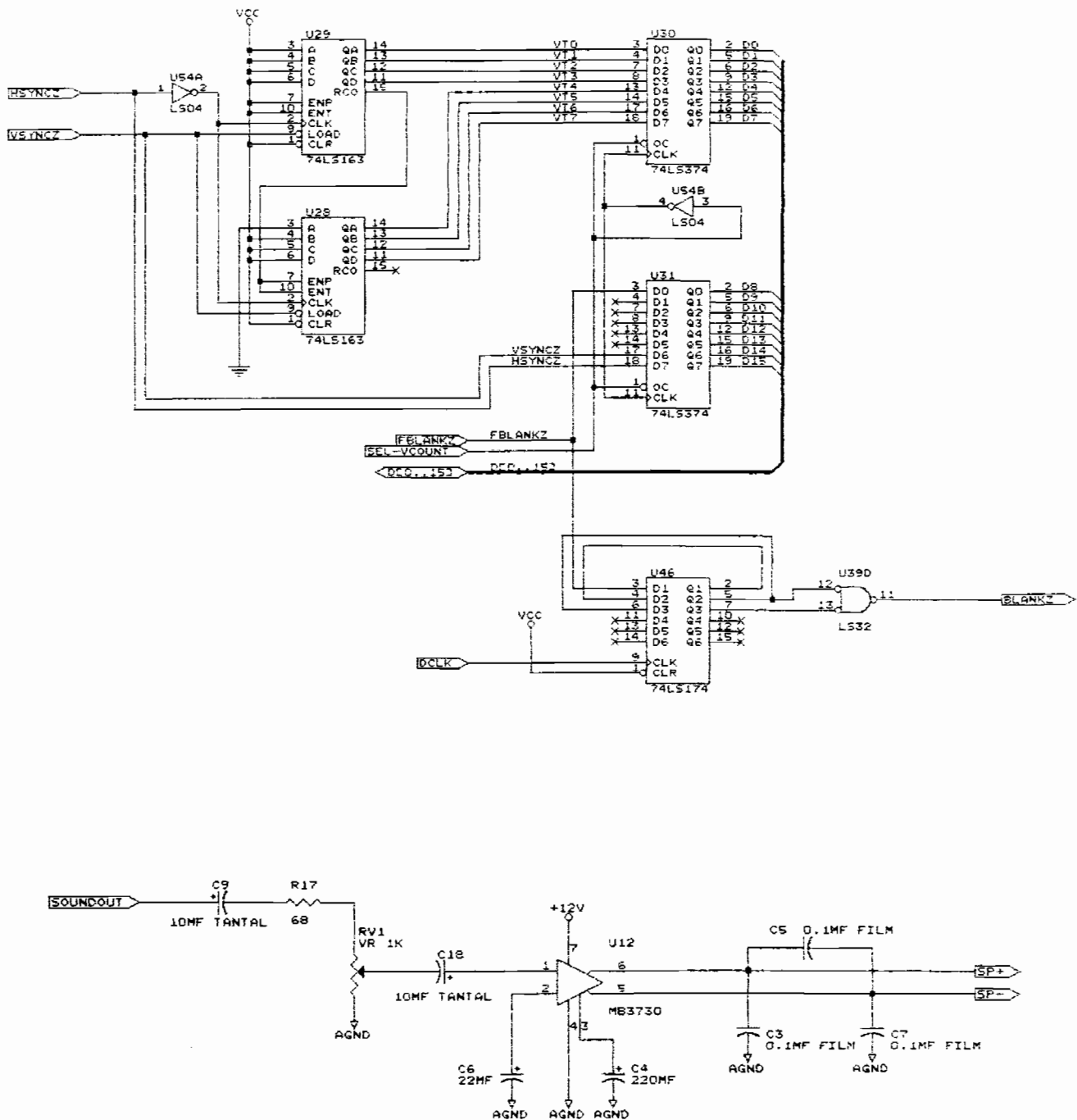


Figure 4-5 Knuckle Bash Game PCB Schematic Diagram

Vertical Line-Counter (top) and Audio Amplifier (bottom)

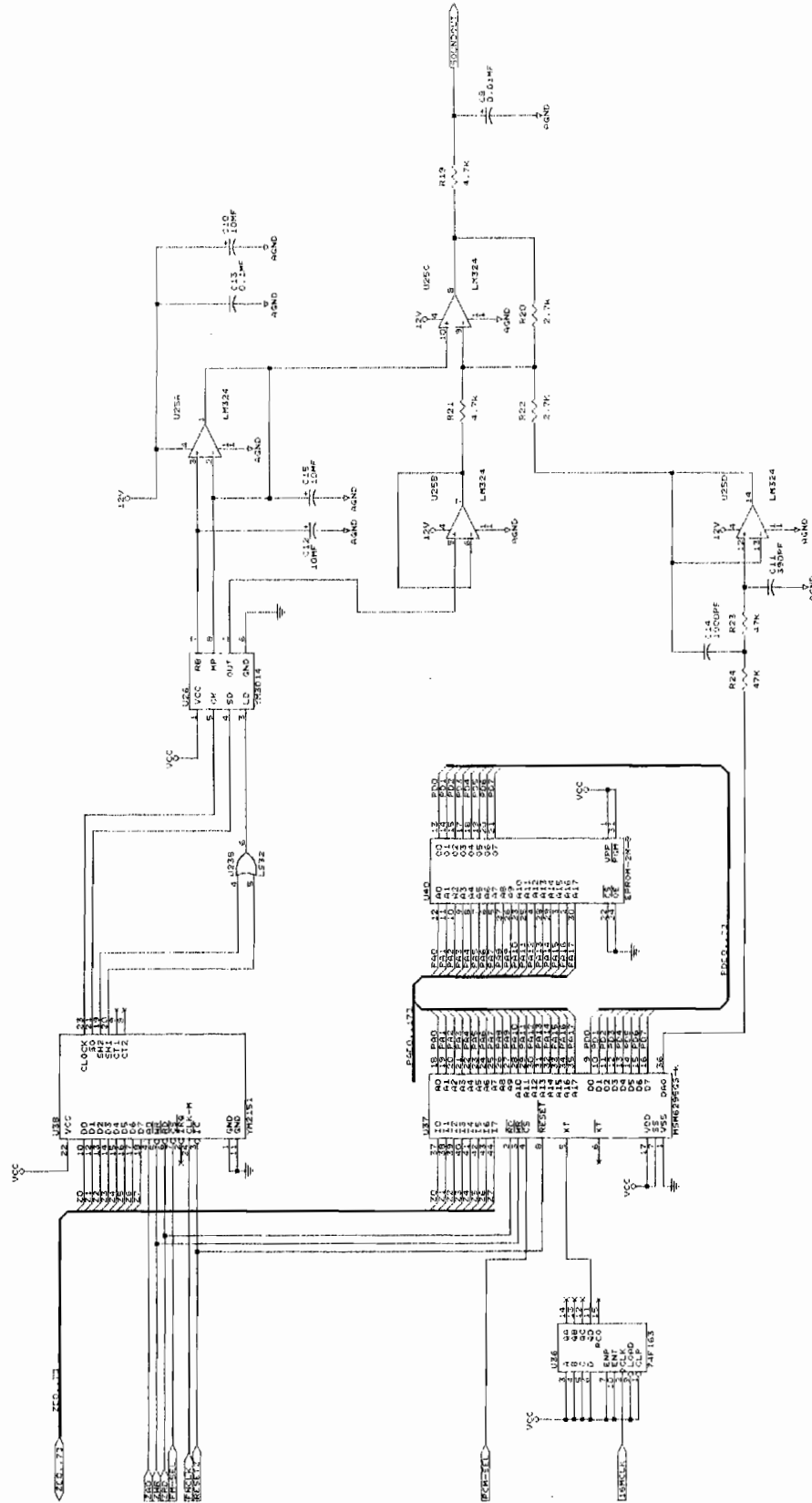


Figure 4-6 Knuckle Bash Game PCB Schematic Diagram
FM and ADPCM Sound Generation

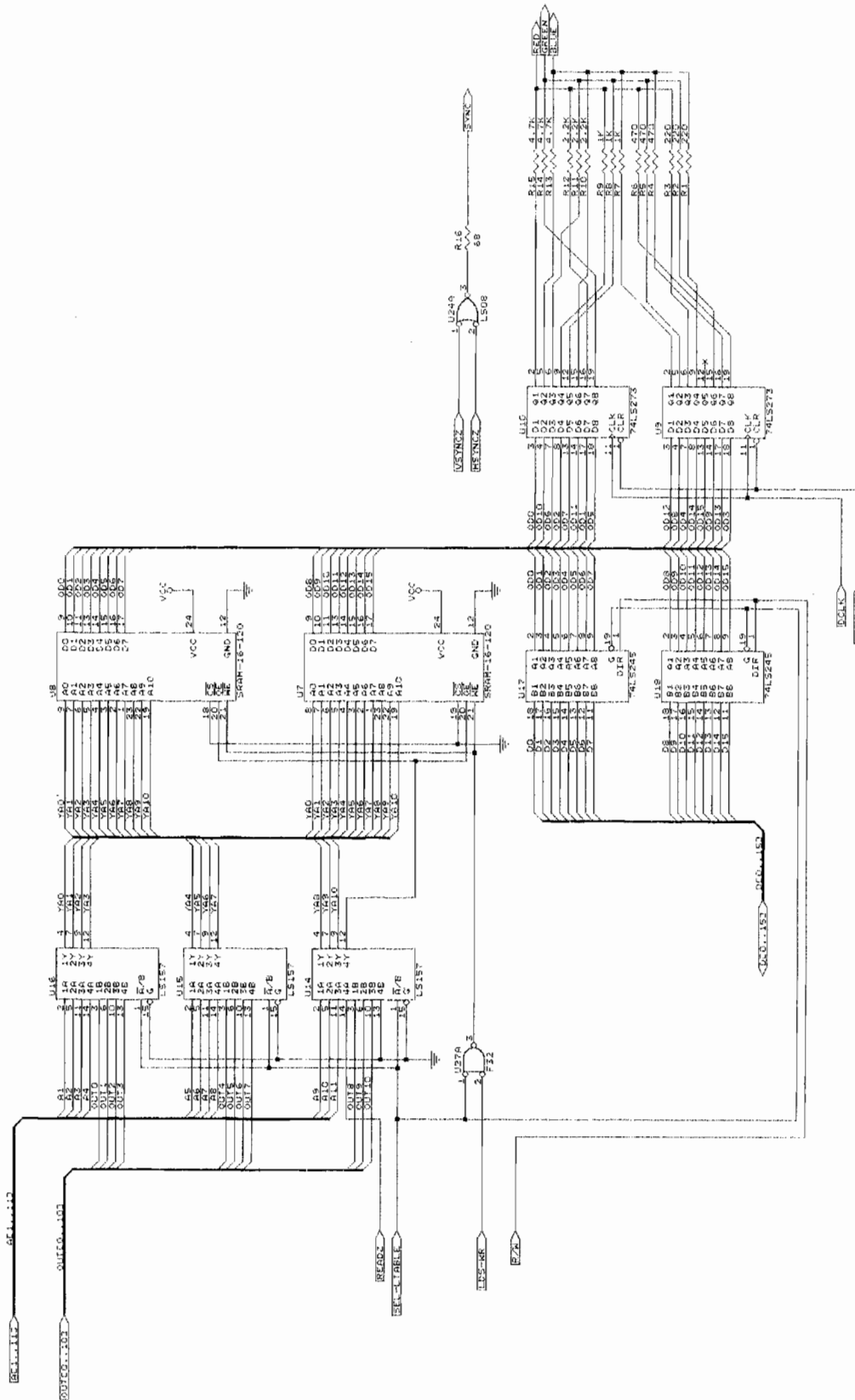


Figure 4-7 Knuckle Bash Game PCB Schematic Diagram
Color Palette Look-up and Video Out

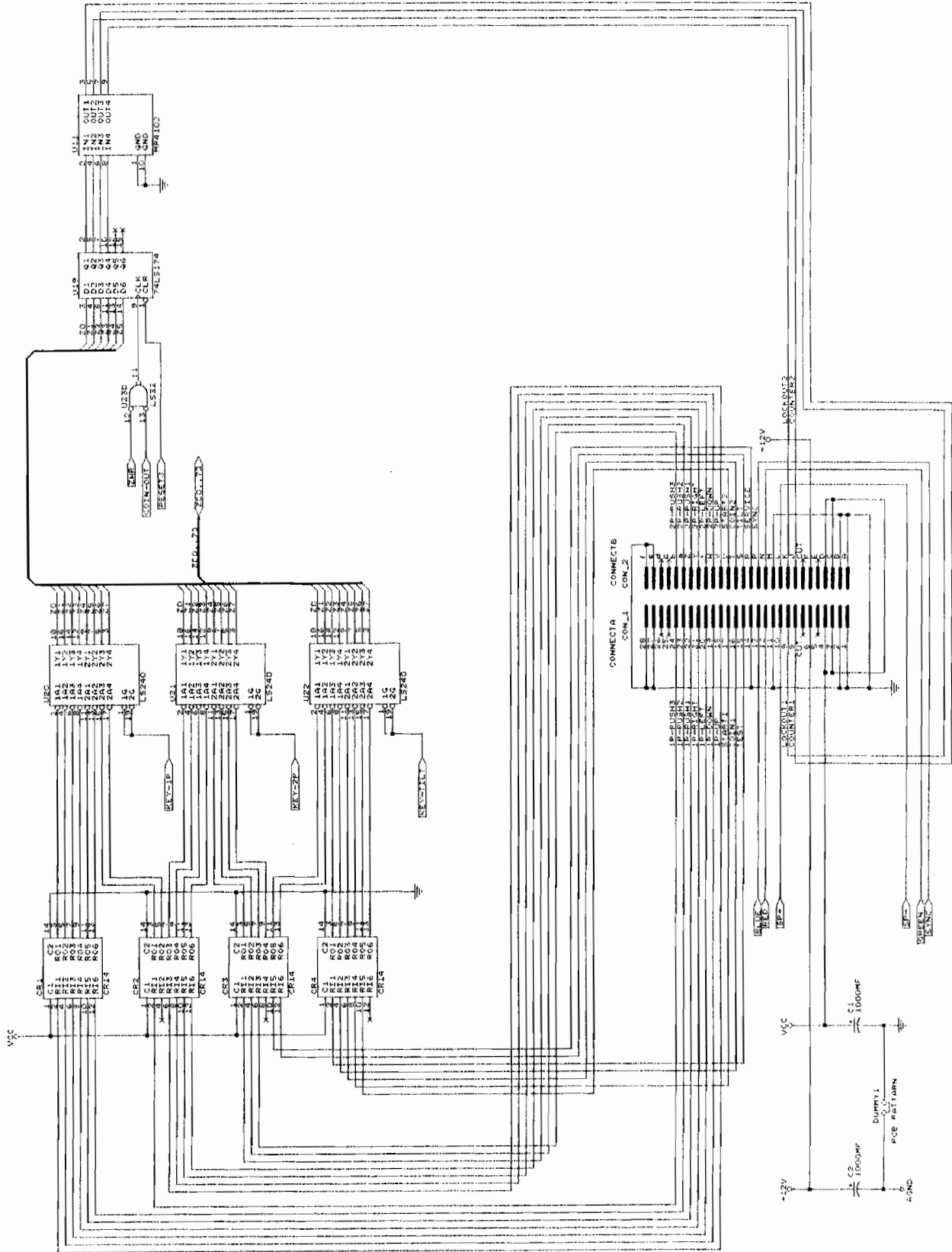


Figure 4-8 Knuckle Bash Game PCB Schematic Diagram
JAMMA and I/O Interface

FROM GAME BOARD

- 1 O — GND
- 2 O — GND
- 3 O — J1+5V
- 4 O — J1+5V
- 5 O — J1-5V
- 6 O — J1+12V
- 7 O — KEY
- 8 O — J1CNTR2
- 9 O — J1LOCK2
- 10 O — J1SPKR1-
- 11 O — J1AUDGND
- 12 O — J1GREEN
- 13 O — J1SYNC
- 14 O — J1SERV
- 15 O — J1TILT
- 16 O — J1RCOIN
- 17 O — J1START2
- 18 O — J1UP2A
- 19 O — J1DOWN2A
- 20 O — J1LEFT2A
- 21 O — J1RT2A
- 22 O — J1FTR2
- 23 O — J1UP2B
- 24 O — J1DOWN2B
- 25 O — J1LEFT2B
- 26 O — J1RT2B
- 27 O — GND
- 28 O — GND
- A O — GND
- B O — GND
- C O — J1+5V
- D O — J1+5V
- E O — J1-5V
- F O — J1+12V
- H O — KEY
- J O — J1CNTR1
- K O — J1LOCK1
- L O — J1SPKR1+
- M O — J1AUD+
- N O — J1RCO
- P O — J1BLUE
- R O — J1VIDGND
- S O — J1SLFTST
- T O — J1LCOIN
- U O — J1START1
- V O — J1UP1A
- W O — J1DOWN1A
- X O — J1LEFT1A
- Y O — J1RT1A
- Z O — J1FTR1
- AA O — J1UP1B
- BB O — J1DOWN1B
- CC O — J1LEFT1B
- DD O — J1RT1B
- EE O — GND
- FF O — GND

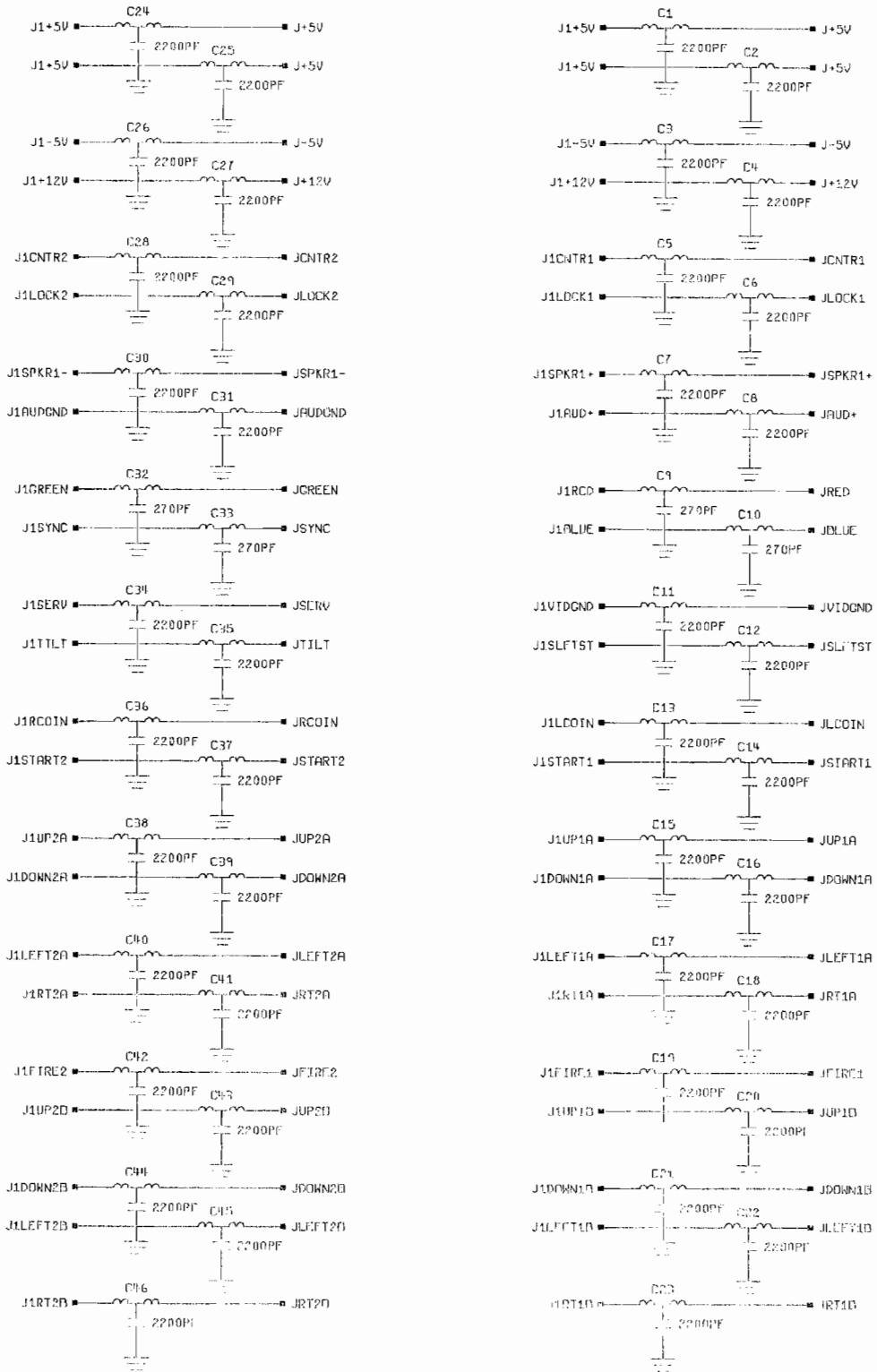


Figure 4-9 JAMMA Filter PCB Schematic Diagram

A047292-02 A

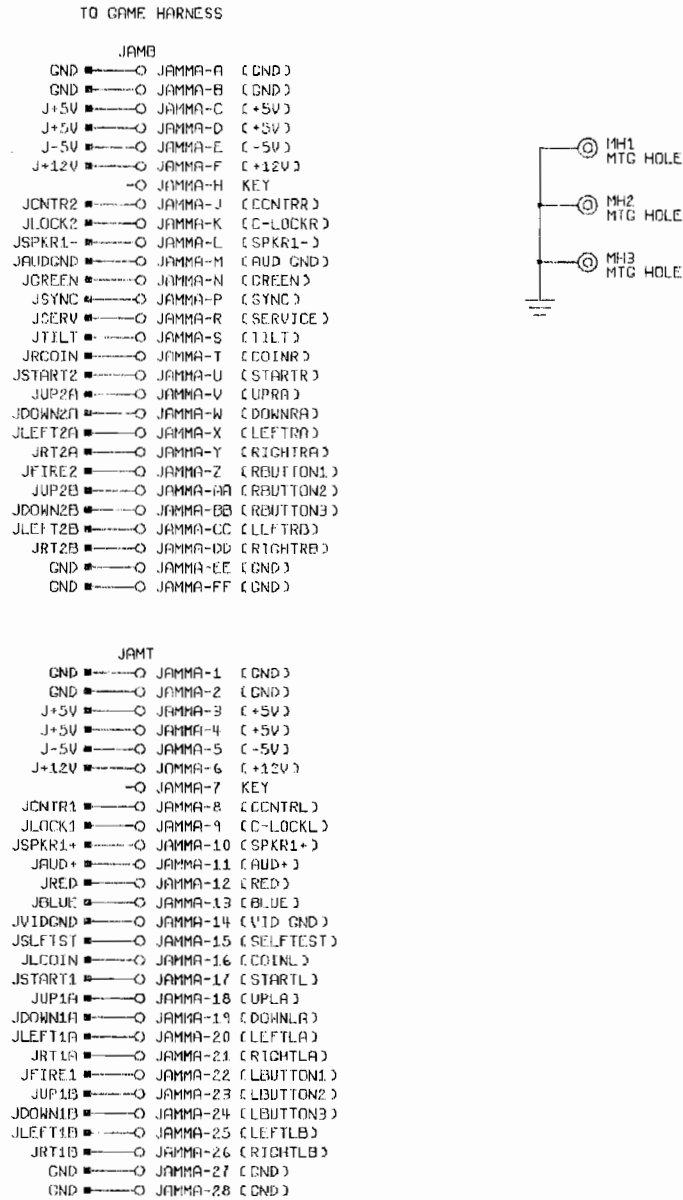


Figure 4-9 JAMMA Filter PCB Schematic Diagram, Continued

A047292-02 A

N O T E S

Warranty

Seller warrants that its printed-circuit boards and parts thereon are free from defects in material and workmanship under normal use and service for a period of ninety (90) days from date of shipment. Seller warrants that its video displays and laser-video disc players (in games supplied with displays and video-disc players) are free from defects in material and workmanship under normal use and service for a period of thirty (30) days from date of shipment. None of the Seller's other products or parts thereof are warranted.

If the products described in this manual fail to conform to this warranty, Seller's sole liability shall be, at its option, to repair, replace, or credit Buyer's account for such products which are returned to Seller during said warranty period, provided:

- (a) Seller is promptly notified in writing upon discovery by Buyer that said products are defective;
- (b) Such products are returned prepaid to Seller's plant; and
- (c) Seller's examination of said products discloses to Seller's satisfaction that such alleged defects existed and were not caused by accident, misuse, neglect, alteration, improper repair, installation, or improper testing.

In no event shall Seller be liable for loss of profits, loss of use, incidental or consequential damages.

Except for any express warranty set forth in a written contract between Seller and Buyer which contract supersedes the terms herein, this warranty is expressed in lieu of all other warranties expressed or implied, including the implied warranties of merchantability and fitness for a particular purpose, and of all other obligations or liabilities on the Seller's part, and it neither assumes nor authorizes any other person to assume for the Seller any other liabilities in connection with the sale of products by Seller.

The use of any non-Atari parts may void your warranty, according to the terms of the warranty. The use of any non-Atari parts may also adversely affect the safety of your game and cause injury to you and others. Be very cautious in using non-Atari-supplied components with our games, in order to ensure your safety.

Atari distributors are independent, being privately owned and operated. In their judgment they may sell parts or accessories other than Atari parts or accessories. Atari Games Corporation cannot be responsible for the quality, suitability or safety of any non-Atari part or any modification including labor which is performed by such distributor.



Atari Games Corporation

675 Sycamore Drive

Milpitas, CA 95035

U.S.A.