

★ JAILBREAK CONVERSION KIT ★

INSTRUCTION MANUAL

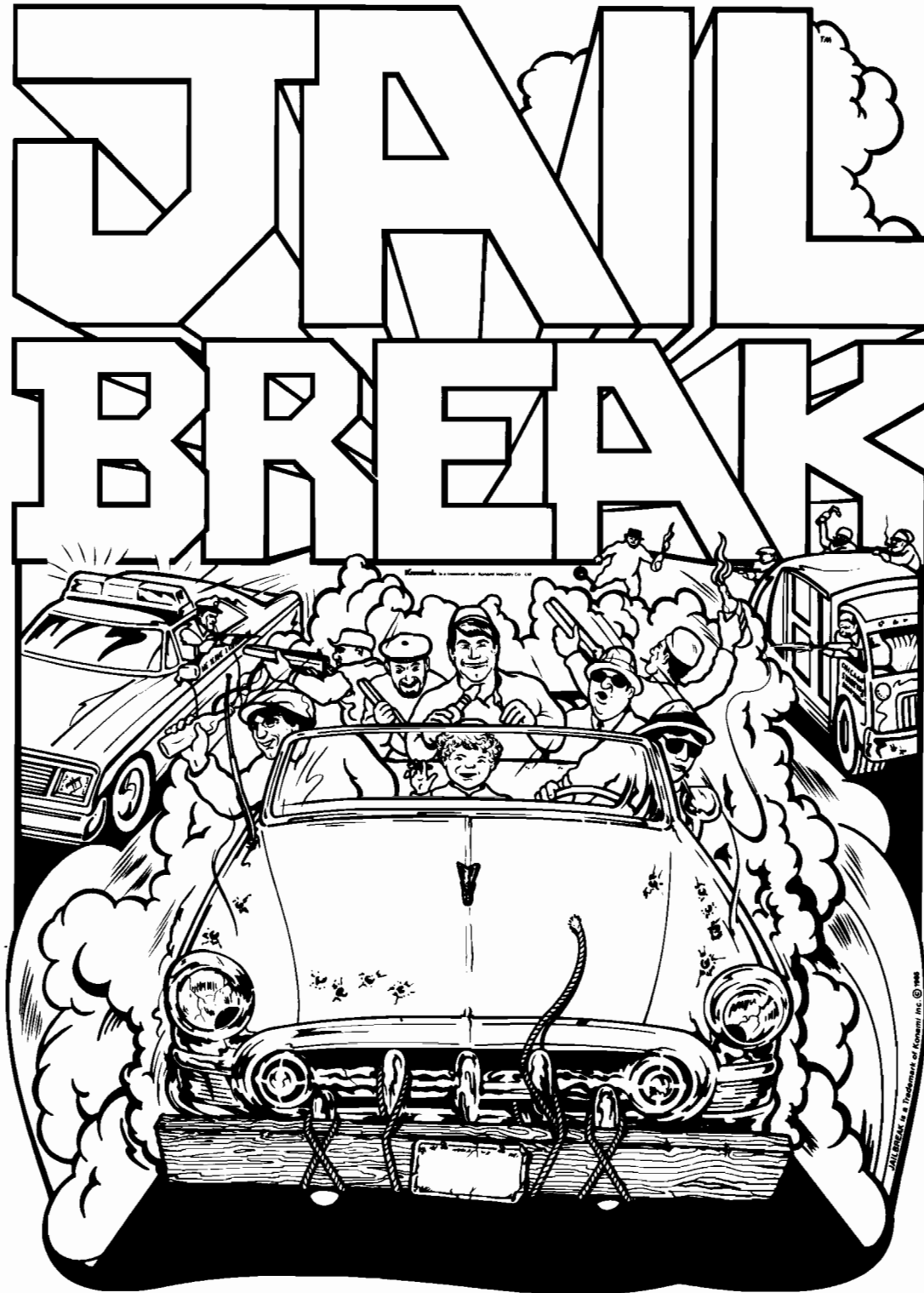

**Konami Inc.**

1555 BRUMMEL AVENUE, ELK GROVE VILLAGE, IL 60007  
TELEPHONE: (312) 364-6633 FAX: (312) 364-1368 TELEX: 6871385 KONAM UW

**JAIL  
BREAK™** is a registered  
trademark of Konami Inc. © 1985 Konami Inc.

**Konami®** is a registered  
trademark of Konami Industry Co., Ltd.

# TABLE OF CONTENTS

---

	Page		Page
Conversion Kit Contents . . . . .	Inside Cover	Wiring Harness Color Code . . . . .	5
Introduction . . . . .	1	Important Installation Notice . . . . .	6
Recommended Control Panel Layouts . . . . .	1	Wiring Diagram . . . . .	7
Graphics . . . . .	2	Technical Information . . . . .	8
Monitor Specifications . . . . .	3	Dip Switch Setting . . . . .	9
Monitor Information . . . . .	4	User Information Warning . . . . .	Back Cover

## CONVERSION KIT CONTENTS:

- MAIN PRINTED CIRCUIT BOARD
- P.C.B. CAGE (FCC REQUIRED)
- CONNECTING WIRING HARNESS
- 6 SETS — BUTTON ASSEMBLIES
- 8-WAY JOYSTICK
- MARQUEE (HEADER)  
(1/8" acrylic sheet)
- ONE SET SIDE PANEL GRAPHICS (left & right)
- CONTROL PANEL OVERLAY
- CONTROL PANEL DECALS  
instruction decals/button decals (2 sets)
- MANUAL
- REGISTRATION CARD

REPLACEMENT ACCESSORIES ARE AVAILABLE THROUGH YOUR DISTRIBUTOR.

THIS KIT USABLE FOR COCKTAIL AND UPRIGHT VIDEO GAMES WITH A RASTAR SCAN MONITOR WHICH IS OR CAN BE MOUNTED HORIZONTALLY.

# JAILBREAK INTRODUCTION

KONAMI CONVERSION KITS are the most complete conversion kits available today. Every detail has been carefully considered, designed and packaged to provide you the means of easily producing a professional conversion.

These kits have all the accessories to easily convert your UPRIGHT or COCKTAIL video game.

We strongly urge you to FULLY STUDY this instruction manual BEFORE you begin your conversion. It contains step-by-step instructions, schematic diagrams and suggestions on how to install your Konami Conversion Kit and maximize your profits.

JAILBREAK can be installed in any horizontally mounted raster scan monitor game.

Everything you will need to construct your new game is provided in this kit. All accessory parts—wiring harness, joystick, etc. are custom made for JAILBREAK by top engineers experienced in the coin-op industry. An 8-way joystick (as provided) MUST be used.

The Player Instruction and Button Control decals are made of a non-destructible acrylic material specifically to keep the player from peeling them off. Should you convert a cocktail table game, JAILBREAK is supplied with 2 sets of button decals.

## SAVE YOURSELF TIME AND MONEY

The following P.C.B.'s are interchangeable with JAILBREAK P.C.B.'s

- Super Cobra • Scramble • Pooyan • Locomotion • Circus Charlie • L'il Hustler
- Juno First • Time Pilot • Gyryss • Tutankham • Turtles • Super Basketball • Mega Zone
- Pandora's Palace • Time Pilot '84 • Track 'n' Field • Hypersports • Roadfighter • Yie-Ar Kung Fu • Kicker
- Rush 'N Attack • Mikie • Frogger (60% — check pin print-out) • Amidar • Roc 'N Rope • The End

In other words, your JAILBREAK will plug right into existing edge connectors of the games listed above — be sure to check your pin print-out. (Keep in mind that JAILBREAK is designed as a horizontal game.)

## DUAL CONTROL

By moving SW#2 of dip switch bank #3 to the "on" position, you are now in the dual control upright mode. This allows you to set up an upright game with two sets of controls rather than one set. The first set of controls should be hooked up to the 1P set of wires; the second set to the 2P wires (see wiring diagrams). Each player still challenges the "computer-controlled" opponent (alternating play). This does not allow simultaneous interaction of players on the video screen.

\*SINGLE CONTROL LAYOUT

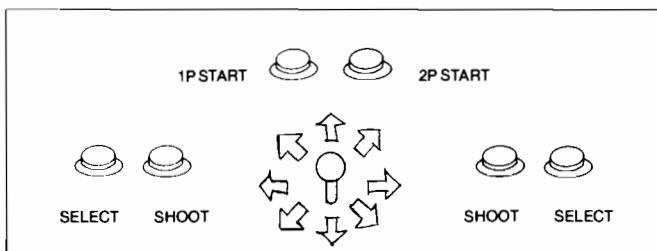

\*RECOMMENDED LAYOUT

DUAL CONTROL LAYOUT

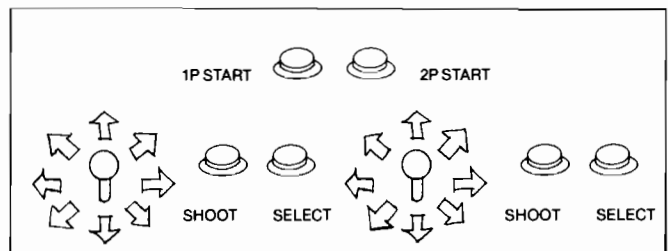

# PUTTING YOUR BEST GAME FORWARD

## PREPARATION:

For best results, all old graphics should be removed completely from the cabinet. "Stick-on" graphics can be removed by using a hairdryer or hot air device. The heat from the dryer will loosen the adhesive, allowing you to easily peel them off — any adhesive residue can be cleaned off with acetone and a soft dry cloth. (DO NOT USE ACETONE ON SURFACES PAINTED WITH FLAT PAINT.)

## TOOLS YOU NEED:

1. Foaming Aerosol (such as "Windex").
2. Soft Squeegee.
3. X-Acto Knife.

## SIDE PANEL DECALS

1. Spray area of cabinet where Side Panel decals are to be applied with foaming aerosol or a mild soap solution.
2. Remove protective backing from decals.
3. Position decals into place.
4. With a soft squeegee, beginning from the center of the decal, slowly and evenly press out excess foam until you achieve a smooth finish.
5. Allow to set approximately 2 to 3 hours before handling. Maximum adherence is achieved in 48 to 72 hours.

6. Trim side decal to fit your cabinet.

## CONTROL PANEL OVERLAY:

1. Refer to Recommended Control Panel Layout on page 1.
2. Drill any new holes needed.
3. Plug any holes that will not be used. (A permanent epoxy filler works well for this step.)
4. Pre-position the overlay prior to removing the backing.
5. Slowly apply the overlay — inch by inch on the control panel, removing the backing as you apply it.
6. Once it's in place, by using an X-Acto knife, cut around the button and joystick placements.

## INSTRUCTION/BUTTON DECALS:

Apply the Player Instruction, Button and 1 Player/ 2 Player decals in their respective positions. Apply pressure liberally. Allow to set as long as possible before putting game on location.

**NOTE:** Maximum adherence is achieved in 48 to 72 hours.

## FCC WARNING LABEL:

FCC Warning Label must be applied to the outside of the cabinet near the line cord entry.

## MARQUEE

(WEAR PROTECTIVE GLASSES WHILE TRIMMING MARQUEE)

1/8" Acrylic Marquee should be cut to fit your game. DO NOT remove protective mask until this is done.

One way of cutting your Marquee is as follows: (Be sure to protect painted side of Marquee from any surface which may scratch or mar finish).

### CUTTING WITH A KNIFE OR SCRIBER

Acrylic sheet up to 3/16" thick may be cut by a method similar to that used for cutting window glass. Use a scribe of some kind — a scribing knife such as the one pictured, a metal scribe, an awl, or even a sturdy craft knife — to score the sheet. Draw the scribe several times (7 or 8 times for a 3/16" thick piece) along a straight edge held firmly in place. It is best not to remove the protective masking. Make the cuts carefully using firm, even pressure. For best results make each stroke cleanly off the edge of the sheet.

Then clamp the acrylic sheet or hold it rigidly under a straight edge with the scribe mark hanging just over the edge of a table. Protect your hands with a cloth, and apply a sharp downward pressure to the other side of the sheet. It will break along the scratch. Scrape the edges to smooth any sharp corners. This method is not recommended for long breaks or thick material.

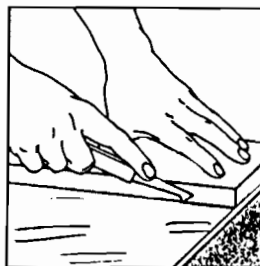

Always draw the scribing knife along a straight edge.

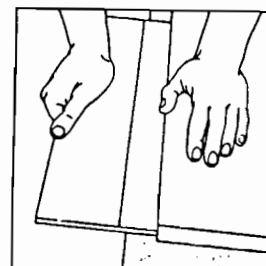

Break sheet over edge of table after scribing.

## P.C.B. CAGE INSTALLATION

Konami, Inc. now supplies a new style P.C.B. cage which is superior to old style cages because of ease of installation. The cage is made of a 32 point stem-stock which is fire retardant.

### TO INSTALL THE CAGE:

1. Open cage bottom and secure to desired P.C.B. position.
2. Install printed circuit board inside cage using wood screws, screwed through the cage bottom into cabinet side.
3. Close the cage over printed circuit board and secure with latch on cage.

# JAILBREAK: MONITOR SPECIFICATIONS

JAILBREAK requires a horizontally mounted monitor. It also generates composite negative sync. If your monitor is composite positive sync, you will have to change to composite negative sync.

- (1) To alternate composite positive sync to composite negative sync, use 7404 IC or 74LS04 IC. The signal on the output pin from the P.C.B. is a combination of H-sync and V-sync.

**NOTE:** Please refer to Figure 2.

**FIGURE 2:**

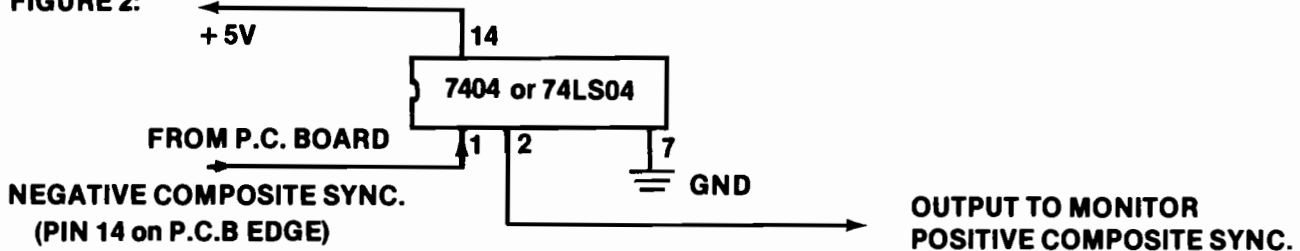

(+ 5V and GND should be taken out of the P.C. Board.)

- (2) Separate Sync modification for JAILBREAK if your monitor has "Separate Sync" input. (For example "Electrohome brand" and Wells-Gardner brand.")

**Step 1**

**WIRING HARNESS**

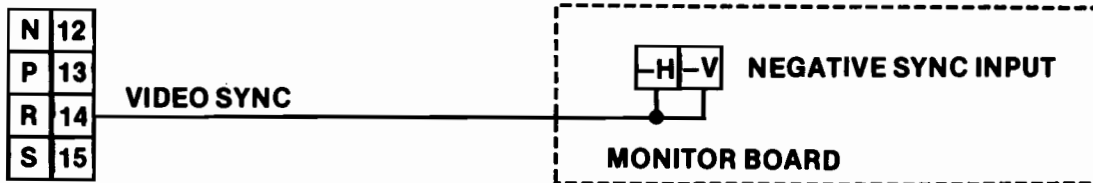

If the picture is still not stable . . .

**Step 2**

Prepare Hook-up wire to separate -H and -V sync. signals.

**WIRING HARNESS**

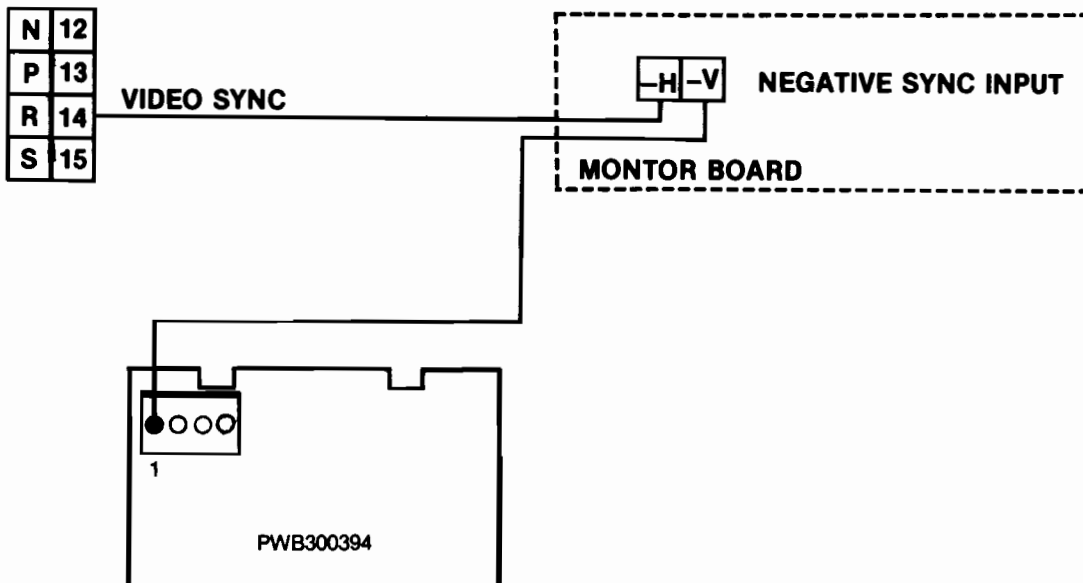

# JAILBREAK: MONITOR INFO.

## SERVICE INSTRUCTIONS

**NOTE:** All monitors are equipped with automatic degaussing coils (L701) which demagnetize the picture tube every time the monitor is turned on after being off for a minimum of 5 minutes. Should any part of the chassis become magnetized it will be necessary to degauss the affected area with a manual degaussing coil. Move the coil slowly around the CRT face and all surrounding metal parts. Then slowly withdraw for a distance of 6 feet before turning off.

### 1.0 BLACK LEVEL CONTROL ADJUSTMENT

This control has been set at the factory and should not need further attention, however, when the game is connected a slight adjustment of VR201 may be necessary to obtain the proper black level (the black portion of the picture just extinguished).

### 2.0 VERTICAL SIZE (HEIGHT)

Location of this control is shown in Fig. 1. This control must be adjusted slowly, if necessary, until the picture or test pattern attains the correct vertical proportions.

### 3.0 CIRCUIT PROTECTION

A 4.0A pigtail fuse, mounted on the Main Board has been provided to protect the Power Output Circuit.

### 4.0 FOCUS

Adjust the focus control, located on the HV unit (T352), for maximum over-all definition and fine picture detail.

### 5.0 HORIZONTAL HOLD CONTROL ADJUSTMENT, VR351 (See Fig. 1)

A warm-up period of at least five minutes should be allowed before alignment is carried out. With the monitor being driven from the game signal, short TP601 to TP31. Adjust VR351 until the picture stops sliding horizontally. Remove the short.

### 6.0 HORIZONTAL VIDEO POSITION

If the video is off center on the raster some compensation can be made by adjusting this control.

### 7.0 VERTICAL RASTER POSITION ADJUSTMENT

If the video is off center vertically, (short dimension of picture tube) some compensation can be made by moving the vertical raster position adjustment jumper to either positions "U" or "D".

### 8.0 HORIZONTAL RASTER POSITION ADJUSTMENT

If the video is off center horizontally (long dimension of the picture tube) some compensation can be made by moving the horizontal raster position adjustment jumper to either positions "R" or "L".

### 9.0 HORIZONTAL WIDTH ADJUSTMENT

The horizontal width coil is a hexagonal tuning tool adjustment. This control must be adjusted slowly, if necessary, until the picture or test pattern attains the correct horizontal proportions.

\* KONAMI GAMES ARE ALL NEGATIVE COMPOSIT SYNC. USE THE THREE PIN CONNECTOR ON THE MONITOR.

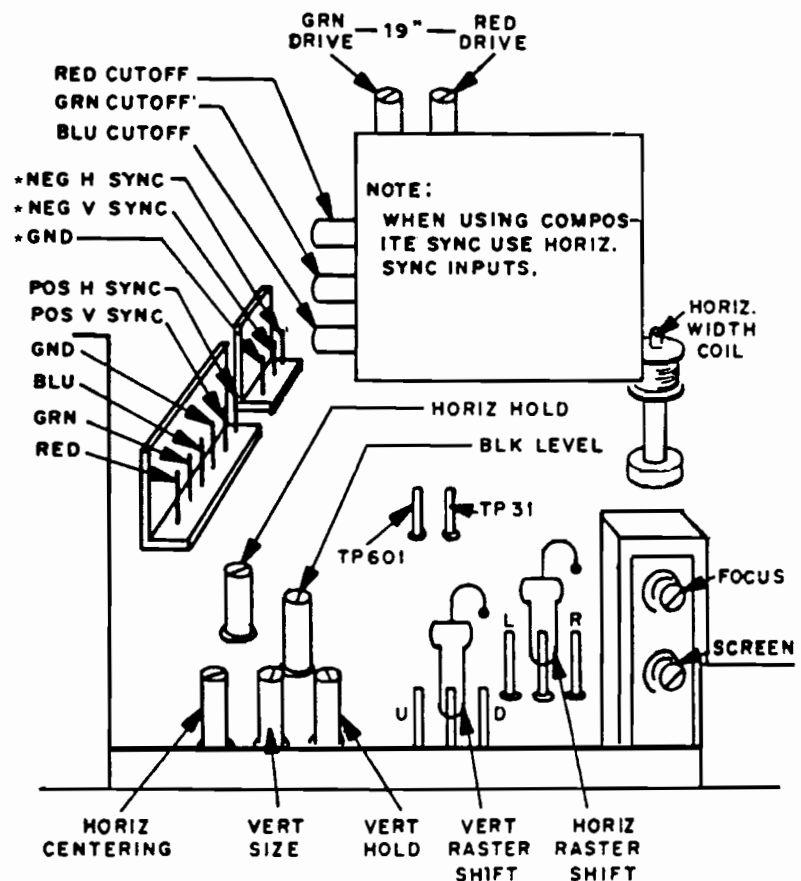

FIGURE 1

# JAILBREAK: WIRING HARNESS

WIRE COLOR KEY:		Solder Side ←		→ Parts Side	
	(EMPTY)	A	1	+ 12V DC	ORANGE
RED/GREEN	SPEAKER OUT	B	2	SPEAKER OUT	ORANGE/GREEN
RED/YELLOW	*2P SHOOT	C	3	2P SELECT*	ORANGE/YELLOW
BROWN/YELLOW	* 2P LEFT	D	4	2P RIGHT*	BLUE/YELLOW
VIOLET/WHITE	1P START	E	5	2P START	VIOLET/YELLOW
ORANGE/WHITE	1P SELECT	F	6	2P UP*	BLACK/YELLOW
RED/WHITE	1P SHOOT	H	7	SERVICE SW	ORANGE/GRAY
BLUE/WHITE	1P RIGHT	J	8	1P LEFT	BROWN/WHITE
BLACK/WHITE	1P UP	K	9	2P DOWN*	GRAY/YELLOW
RED/GRAY	COIN 1	L	10	COIN 2	BLUE/GRAY
GRAY/WHITE	1P DOWN	M	11	COIN COUNTER 1	GREEN/GRAY
WHITE/PINK	(NOT USED)	N	12	COIN COUNTER 2	YELLOW/GRAY
GREEN/BROWN	VIDEO GREEN	P	13	VIDEO BLUE	BLUE/BROWN
RED/BROWN	VIDEO RED	R	14	VIDEO SYNC	WHITE/BROWN
	(EMPTY)	S	15	(NOT USED)	YELLOW/PINK
BLACK	GND	T	16	GND	BLACK
BLACK	GND	U	17	GND	BLACK
RED	+ 5V DC	V	18	+ 5VDC	RED

(BASE COLOR/LINE COLOR)

\*Cocktail Table or Dual Control  
Upright Only

# IMPORTANT INSTALLATION NOTICE FOR JAILBREAK

The solid red heavy gauge wires on the edge connector must be inserted at position B18 & B1, as shown in the diagram below. **\*Reverse condition will result in board damage!**

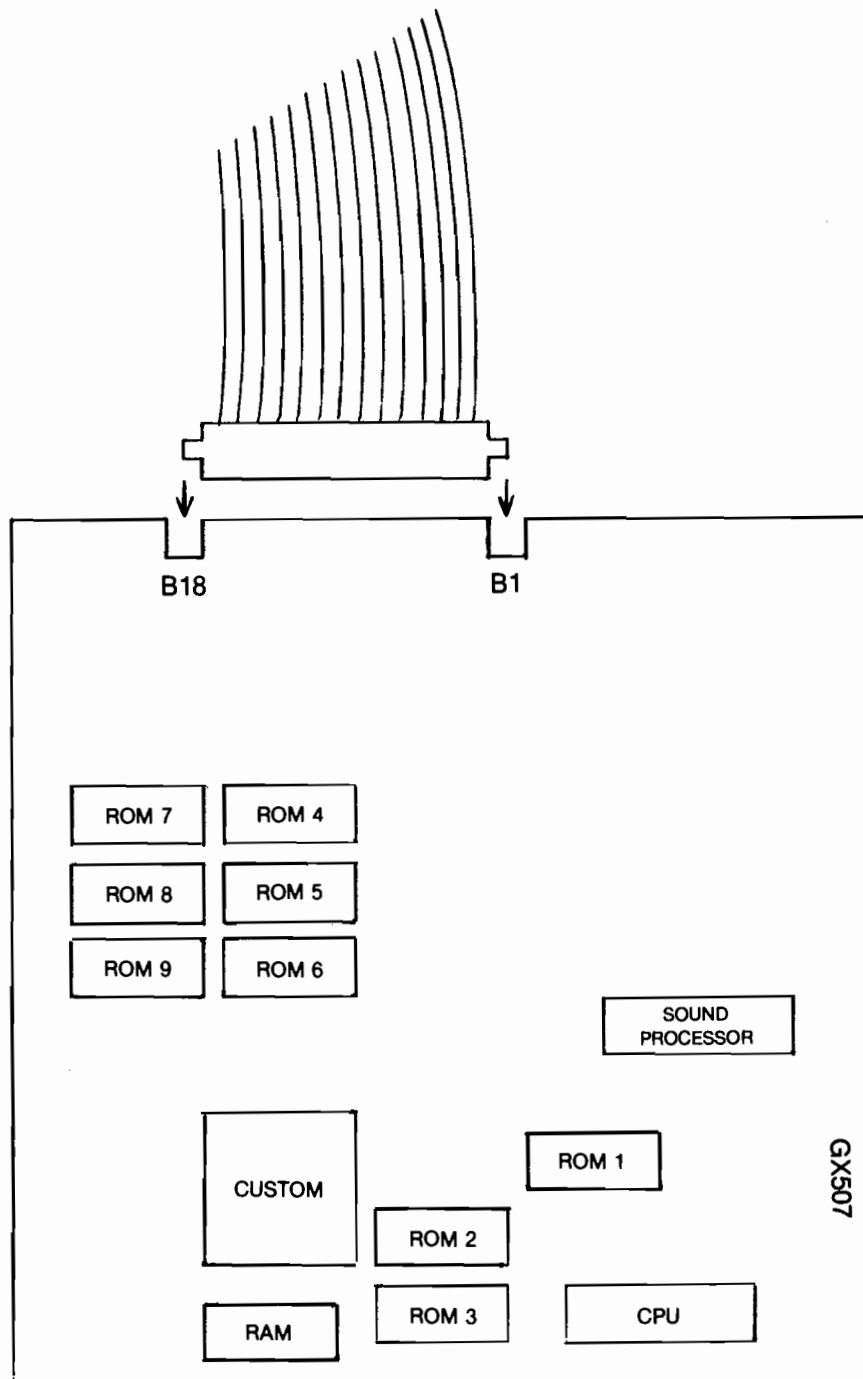



# JAILBREAK WIRING DIAGRAM

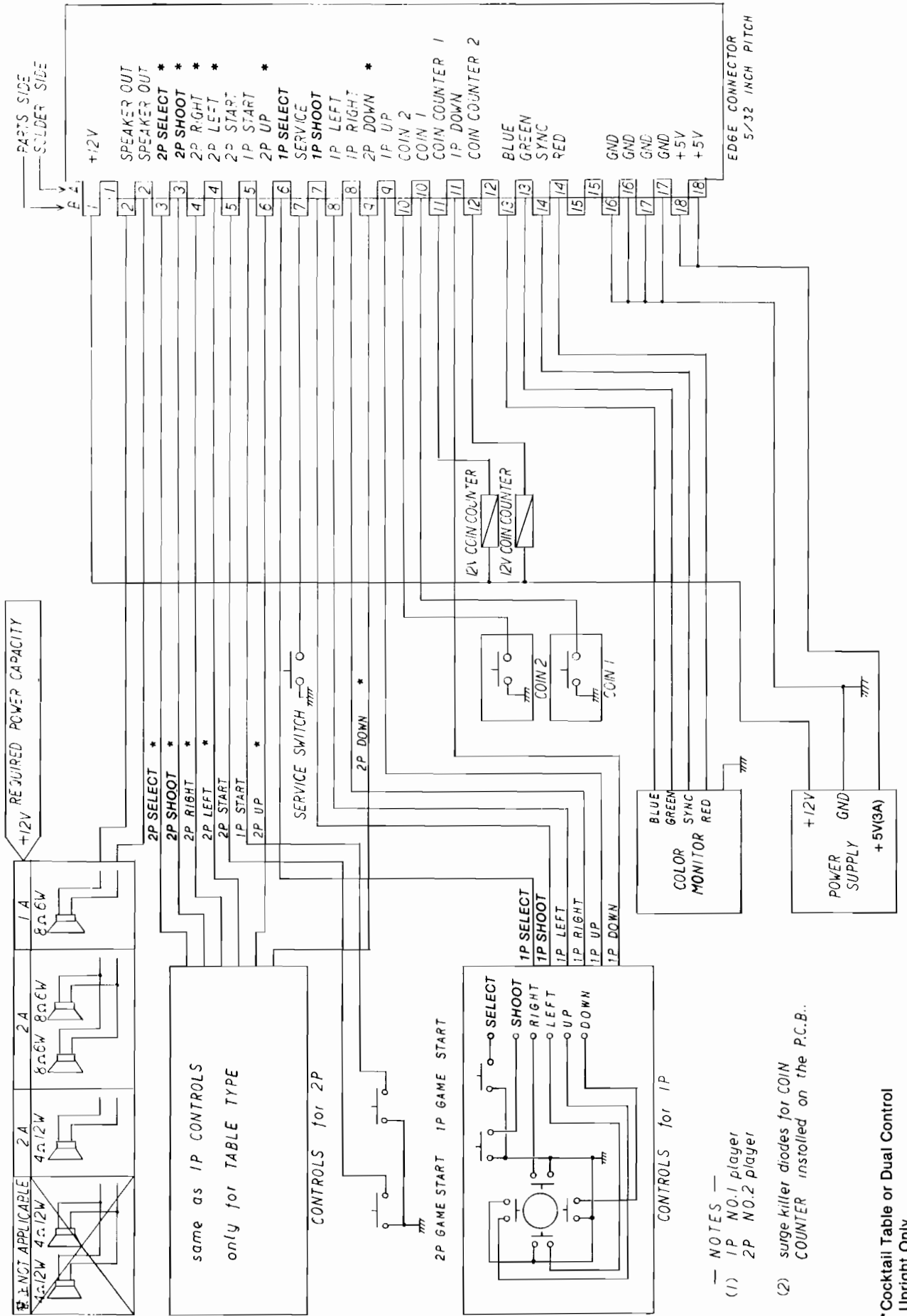

# JAILBREAK: TECHNICAL INFORMATION

(1) Required Power Capacity

+5V DC      3A or more.

+12V DC      See Figure 1 below

**Figure 1:**

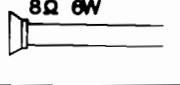
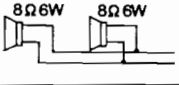
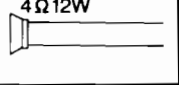
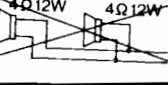
<b>SPEAKER</b>				
<b>Required Power Capacity</b>	12V 1A	12V 2A	12V 2A	Not Applicable

(2) Signal output

- R(red) analog, positive
- G(green) analog, positive
- B(blue) analog, positive
- Sync. H-V composite negative

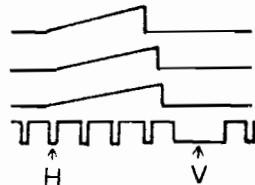

## DIAGNOSTIC PROCEDURES

**AUTOMATIC SELF-TEST** — Upon "Power On", this system will automatically test ROMS and VIDEO RAMS. The screen will display pass or fail conditions as follows:

TEST PASSED	TEST FAILED	IF TEST FAILS
RAM 1 OK	RAM 1 BAD	RAM 1 = 11 E
RAM 2 OK	RAM 2 BAD	RAM 2 = 8 E
ROM 1 OK	ROM 1 BAD	ROM 1 = 11 D
ROM 2 OK	ROM 2 BAD	ROM 2 = 9 D

# DIP SWITCH SETTINGS

## DIP SW No. 1 Settings

Coin 1 Switch Set

SW	4	3	2	1	COIN	PLAY
•	OFF	OFF	OFF	OFF	1	1
			OFF	ON	1	2
			ON	OFF	1	3
			ON	ON	1	4
	OFF	ON	OFF	OFF	1	5
			OFF	ON	1	6
			ON	OFF	1	7
			ON	ON	2	1
	ON	OFF	OFF	OFF	2	3
			OFF	ON	2	5
			ON	OFF	3	1
			ON	ON	3	2
	ON	ON	OFF	OFF	3	4
			OFF	ON	4	1
			ON	OFF	4	3
			ON	ON	FREE PLAY	

Coin 2 Switch Set

SW	8	7	6	5	COIN	PLAY
•	OFF	OFF	OFF	OFF	1	1
			OFF	ON	1	2
			ON	OFF	1	3
			ON	ON	1	4
	OFF	ON	OFF	OFF	1	5
			OFF	ON	1	6
			ON	OFF	1	7
			ON	ON	2	1
	ON	OFF	OFF	OFF	2	3
			OFF	ON	2	5
			ON	OFF	3	1
			ON	ON	3	2
	ON	ON	OFF	OFF	3	4
			OFF	ON	4	1
			ON	OFF	4	3
			ON	ON	INVALIDITY	

## DIP SWITCH NO. 2 SETTINGS

THE NUMBER OF PLAYER'S LIFE

SW	1	2	NUMBER
•	OFF	OFF	1
	ON	OFF	2
	OFF	ON	3
	ON	ON	5

SOUND IN ATTRACT MODE

SW	8	SOUND
•	OFF	OFF
	ON	ON

\*SW 7 NOT USED

CHANGE OF TABLE OR UP-RIGHT

SW	3	TYPE
•	OFF	TABLE
	ON	UP-RIGHT

## DIP SWITCH NO. 3 SETTINGS

Video Screen Flip

SW	1	
•	OFF	NORMAL
	ON	UPSIDE DOWN

BONUS SET

SW	4	FIRST BONUS	SECOND
•	OFF	30,000	Every 70,000
	ON	40,000	Every 80,000

Single/Dual Control Upright

SW	2	TYPE
•	OFF	SINGLE UPRIGHT CONTROL
	ON	DUAL UPRIGHT CONTROL

Difficulty of the Game

SW	5	6	DIFFICULTY
•	OFF	OFF	EASY
	ON	OFF	NORMAL
	OFF	ON	DIFFICULT
	ON	ON	VERY DIFFICULT

\*SW 3 & SW 4: NOT USED

USER INFORMATION  
**WARNING**  
F. C. C. REGULATION COMPLIANCE

THIS KIT IS INTENDED FOR USE ONLY ON COIN-OPERATED VIDEO GAMES MANUFACTURED AFTER OCTOBER 1, 1983 WHICH HAVE BEEN VERIFIED FOR COMPLIANCE WITH REQUIREMENTS IN PART 15 OF F.C.C. RULES FOR A CLASS A COMPUTING DEVICE.

IMPROPER CONNECTION OF THIS KIT OR CONNECTION TO ANY OTHER GAME NOT SO MANUFACTURED OR VERIFIED FOR COMPLIANCE MAY CAUSE UNACCEPTABLE INTERFERENCE TO RADIO AND T.V. RECEPTION, REQUIRING THE OPERATOR TO TAKE WHATEVER STEPS ARE NECESSARY TO CORRECT THE INTERFERENCE.

THE P.C. BOARD CAGE SUPPLIED WITH THIS CONVERSION KIT MUST BE UTILIZED AND TERMINATED TO GROUND AT THE TIME OF INSTALLATION.

**Konami®**

1555 BRUMMEL AVENUE, ELK GROVE VILLAGE, IL 60007  
TELEPHONE: (312) 364-6633 FAX: (312) 364-1368 TELEX: 6871385 KONAM UW