

Nintendo

namco America Inc.

**DONKEY KONG
DONKEY KONG JUNIOR
MARIO BROS**

UPRIGHT AND CABARET

Operator's Manual

Important

**Read PRECAUTIONS and INSTALLATION
Sections before operating game**

FCC Notice

Note: This equipment has been tested and found to comply with the limits for a Class A digital device, pursuant to Part 15 of the FCC Rules. These limits are designed to provide reasonable protection against harmful interference when the equipment is operating in a commercial environment. This equipment uses, and can radiate radio frequency energy and, if not installed and used in accordance with the instruction manual, may cause harmful interference to radio communications. Operation of this equipment in a residential area is likely to cause harmful interference in which case the user will be required to correct the interference at his own expense.

Copyright 1981-2004 NINTENDO & NAMCO AMERICA INC. - All rights reserved

No part of this publication may be reproduced by any mechanical photographic, or electronic process, or in the form of a phonographic recording, nor may it be stored in a retrieval system, transmitted, or otherwise copied for public or private use, without permission from NINTENDO & NAMCO AMERICA INC.

TABLE OF CONTENTS

1.0 SPECIFICATIONS..... 2

1.1 JAMMA IDENTIFICATION..... 3

2.0 PRECAUTIONS..... 4

 2.1 Installation..... 4

 2.2 Handling..... 4

3.0 INSPECTION..... 5

4.0 INTRODUCTION 6

5.0 GAME PLAY 6

6.0 SCREENS 10

 Figure 1: Main Menu Screen..... 10

 Figure 2: Coin / Game Options Screen..... 11

 Figure 3: Audits Screen 11

 Figure 4: Controls Test Screen 12

 Figure 5: Video Tests Screen 13

 Figure 6: Load Factory Default Screen 13

7.0 MAINTENANCE..... 14

 8.1 Monitor Service 14

8.0 TROUBLESHOOTING..... 15

9.0 PARTS LIST 16

APPENDIX A: Wiring Diagram..... 18

1.0 SPECIFICATIONS

Input Power: 120 VAC, 60 Hz, 3 Amp
200 Watts Maximum

Standard: JAMMA standard 56 pin JAMMA edge terminal

Input Power: 120 VAC, 60 Hz, 3 Amp 250 Watts Max

Installed Dimensions: UPRIGHT: 25.5" W x 34" D x 66.5" H

CABARET: 22" W X 33" D X 60" H

Installed Weight: UPRIGHT: 284 Lbs.

CABARET: 224 Lbs

Packed Dims: UPRIGHT: 29" W x 36" D x 76" H

CABARET: 24" W x 35" D x 68" H

Packed Weight: UPRIGHT: 330 Lbs

CABARET: 260 Lbs

WARNING

**REMOVAL OF SERIAL NUMBERS AND/OR BAR-CODES FROM PRODUCT OR
COMPONENTS WILL VOID THE WARRANTY**

1.1 JAMMA IDENTIFICATION

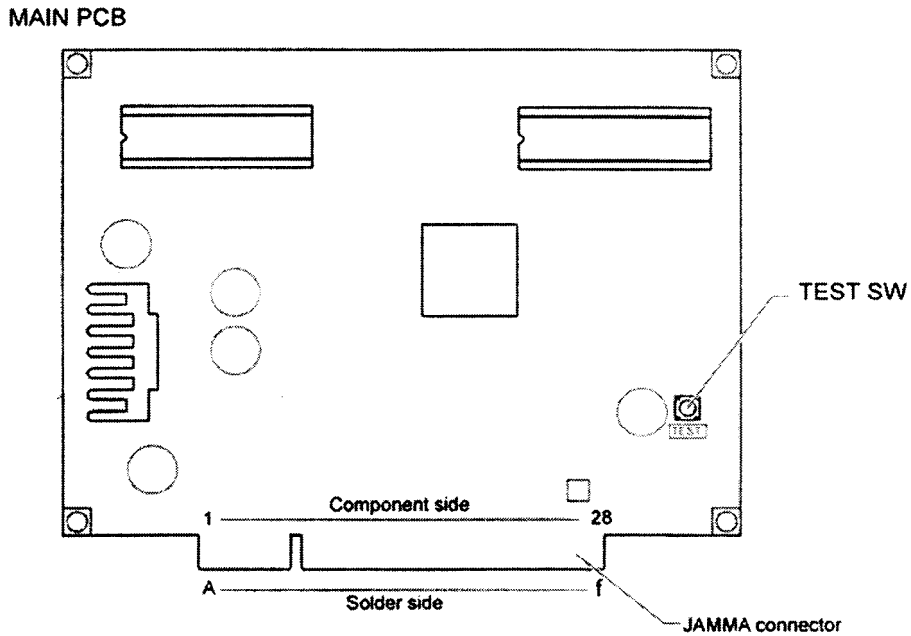

Component side		Solder side	
1	GND	A	GND
2	GND	B	GND
3	+5V	C	+5v
4	+5v	D	+5v
5		E	
6	+12V	F	+12v
7	POST	H	POST
8	METER1	J	
9		K	
10	SPEAKER (+)	L	SPEAKER (-)
11		M	
12	VIDEO R	N	VIDEO G
13	VIDEO B	P	VIDEO SYNC
14	VIDEO GND	R	(SERVICE)
15	TEST	S	
16	COIN 1	T	COIN 2
17	START 1	U	START 2
18	1P UP	V	2P UP
19	1P DOWN	W	2P DOWN
20	1P LEFT	X	2P LEFT
21	1P RIGHT	Y	2P RIGHT
22	1P BUTTON 1	Z	2P BUTTON 1
23	1P BUTTON 2	a	2P BUTTON 2
24	1P BUTTON 3	b	2P BUTTON 3
25		c	
26		d	
27	GND	e	GND
28	GND	f	GND

2.0 PRECAUTIONS

2.1 INSTALLATION

This game is designed for indoor use only. It must *not* be installed outdoors. The following conditions must be avoided.

1. Direct exposure to sunlight, high humidity, direct water contact, dust, high heat, or extreme cold.
2. Vibration. The game must be installed on a level surface with levelers and/or casters in place.

Do not install in an area such that the game would present an obstacle in case of an emergency (i.e., near fire equipment or emergency exits).

2.2 HANDLING

1. Before operating the game, make sure that the main AC power hookup includes a safety ground. This will ensure safe operation as well as compliance with FCC and UL regulations. Measure the AC power line voltage. Verify that the voltage source is between 110 and 125 VAC.
2. Before replacing any parts, turn the AC power OFF and unplug the game.
3. When unplugging the game from an electrical outlet, always grasp the plug, not the line cord.
4. The game power supply includes areas of high voltage. Take care at all times to avoid electrical shock whenever inspecting or adjusting the game.
5. Do not attempt to repair the Printed Circuit Boards (PCBs) on-site. They contain sensitive integrated circuit chips that could be easily damaged, even by the small internal voltage of a multimeter. Always return the PCBs to your distributor for any repairs.
6. Always raise the leg levelers before attempting to move the game.

WARNING

When packing PCB's for shipment, enclose in anti-static wrap. NAMCO America Inc. is not responsible for damage to components due to static discharge.

3.0 INSPECTION

To ensure a successful startup following shipment, the game cabinet should be inspected before initial power-up.

1. Carefully remove the game cabinet from its shipping platform and inspect it for visible signs of damage.

If your game exhibits signs of damage be sure to document it and contact your distributor and transportation carrier immediately.

2. Remove the keys from the coin return. Open and remove the rear access panel.
3. Inspect the game PCB, verifying that all connections are properly seated. Inspect the power supply area for any loose components.
4. Connect the main AC power cord and turn on the power.

4.0 INTRODUCTION

DONKEY KONG

Poor Mario. Just when things were going so well for him – new girlfriend, new car, new job – that beastly ape Donkey Kong kidnaps Mario's girlfriend and drags her off screaming to the top of a steel fortress. To save her, Mario must climb to the top of the fortress, remove dangerous rivets, and fend off life-threatening barrels and fireballs that the ape throws down at him. It's a tough fight, and Mario needs your help. Be a chum. Be a hero. Help Mario save his girlfriend.

DONKEY KONG JR

Donkey Kong the ape is back. Only this time the vengeful Mario is holding the ape prisoner. Luckily the ape has a son, Donkey Kong Junior, who will try to rescue Papa. To free his dad, Junior must make his way through a dark and treacherous jungle. Racing against time, the little fellow climbs and swings across vines, while avoiding the terrible Snapjaws. If he reaches the keys to Papa's cage, Junior must push them to the top of chains while staying clear of Snapjaws and a new flock of nasty Nitpickers. But even then his mission isn't over. Once he reaches Mario's hideout, he must pass yet another test against time. This kid needs help. Don't just stand there! Help poor Junior save his father!

MARIO BROS.

Mario the carpenter and his brother Luigi are hopping mad! The water pipes in their house are blocked with pesky crawling creatures. If the two of them can't get rid of them, they'll never take a bath again!

5.0 GAME PLAY

DONKEY KONG

Move the joystick left or right to make Mario run on the ramps. To help him up and down ladders, first position him under or over the ladder, and then move the joystick up or down. Mario can descend only unbroken ladders. Press the JUMP button on the control panel to make Mario jump over rivets, barrels and fireballs, or grab the hammer, Mario's only weapon against barrels and fireballs. It's easier for him to jump over a barrel or fireball when he's running toward it. If one of those nasties is heading toward him, don't let him be caught on a ladder or with his back turned. When Mario jumps and grabs the hammer, he can hit the barrels or fireballs by first facing them, and then hitting them with the hammer. Once Mario has the hammer, you should act quickly – the hammer will soon disappear. If you miss, you'll lose Mario. Don't try to climb the ladders with the hammer. Mario won't make it.

THE STEEL FORTRESS

The steel fortress has three screens: a ramp screen, a rivet screen and an elevator screen. The game begins with the ramp screen. Here Mario must climb to the top of the screen. Donkey Kong rolls barrels down the ramps to make the going tough. Mario can run away from the barrels, leap over them or smash them with a hammer. When Mario makes it to the top of the ramps, he'll proceed to the rivet screen. On the rivet screen, Mario must remove all of the rivets by either running or jumping over them. At the same time, he must avoid the fireballs that are chasing him. When Mario eliminates every rivet, he'll proceed to the elevator screen. Mario must use the elevators to make his way across several platforms while avoiding the mad springs bouncing at the top of the screen. From the elevator screen he'll return to the ramp screen to continue his rescue mission at a more difficult level. From here, you can continue the game indefinitely until you run out of Mario's. Each screen has a score/bonus points counter at the top. You'll start with 5000 bonus points. You're racing against the clock, so if the counter reaches zero, you lose a Mario. As you go from screen to screen, you'll take your bonus points with you.

SCORING:

Get purse, umbrella.....	300 points
Jumping a barrel.....	100 points
Removing a rivet.....	100 points
Smashing a barrel or fireball.....	300 points
Extra life at.....	20000 points

You begin with three Marios: a player and two backups. If you lose a Mario, a backup is there to take over. Backups begin at the bottom of the screen. When all the Marios are used up, the game is over.

DONKEY KONG JUNIOR

The joystick directs Junior's climbing and jumping, and the jump button controls his jumping.

Climbing and Sliding. Move the joystick up to help the little ape climb up vines or chains. Move it down to help him slide down. Junior can climb up two vines or chains faster than he can climb one. But he'll slide down one vine or chain faster than he'll slide down two. Junior can't climb through platforms.

Swinging Through the Jungle. Move the joystick left or right to position the little ape on the side of the vine or chain closest to his destination. Then, move the joystick again toward the adjoining vine or chain.

Jumping. Press the jump button to make Junior jump in place while standing. Press the button while Junior is running to make him jump in the direction he's facing. To move from a vine or a chain onto a platform, move the joystick in the

direction of the platform. Junior must be on an adjoining vine or chain and above the platform before he can move onto it.

Running. If Junior is standing on a flat surface, move the joystick left or right to make him run in that direction.

MARIO BROS.

Your task is to help Mario kick the pipe pests off the floors and into a bucket of water. Press the jump button to make Mario jump up and punch the floor (and the pest) above him. Move the joystick left or right to make Mario run into stunned pests to kick them. Press the jump button while Mario is running to make him jump from floor to floor. Mario starts the game with three lives. Each time he kicks a pest off a floor, you earn points. If an active pest or a fireball catches Mario, he loses a life. When all the pests are knocked off, the next phase begins.

You earn an extra life at 20,000 points. Scores and the number of lives remaining appear at the top of the screen. The high score appears in the top center. The phase you're playing appears in the bottom left corner of the screen.

A coin spurts out of a water pipe each time Mario kicks a pest off the floor. Make Mario run into the coin or punch it from below to earn 800 bonus points.

The POW switch appears near the bottom center of the screen. When Mario hits the switch, it delivers a punch to all pests on the screen. You can use the POW switch three times before it disappears. You receive a new POW switch in rounds 8 and 13, and every fifth round after that.

The game ends when Mario loses all his lives. Press jump to begin a new game.

COIN PHASE: At certain times during the game, the pests disappear and a coin phase begins. The screen is filled with dangling coins. Mario has only a few seconds to grab as many coins as possible. Every coin Mario gets earns 800 bonus points. A timer at the top of the screen counts down the seconds: 20 seconds for each coin phase. Extra points are awarded if Mario gets all the coins before the time expires.

TWO-PLAYER GAME: In two-player games, one player is Mario and the other player is Luigi. Luigi plays the game the same way Mario does. You can work as a team, with one player punching the pests and the other player kicking them off the floor. Or you can compete with each other for the highest score. If you do, watch out for the sneak attacks – your opponent may punch a pest back on its feet just as you're about to kick it off the floor!

THE PESTS: Knocking off a pest is a two-part maneuver. First, punch the floor directly beneath a pest to flip it onto its back. Then jump up to the floor and kick the stunned pest off the floor before he recovers.

Eliminate SHELLCREEPERS by punching them once from below and then kicking them off the floor before they can get away.

At the first punch, SIDESTEPPERS become enraged and start moving faster. Punch them again to flip them over, then kick them off the floor.

FIGHTERFLIES hop from one section of the floor to another. The only time Mario or Luigi can flip one over is when it's touching the floor.

In higher levels SLIPICE appears. He's a mean iceman who freezes floors into slippery ice. Punch him from below to keep him from chilling the floors.

FIREBALLS can fry Mario and Luigi to a crisp. Avoid fireballs by jumping over them or by jumping to another level. Punch fireballs to destroy them.

PLUMBING TIPS: Use your POW switch when more than one pest is on the screen.

Watch out for the last pest on the screen. It speeds up and is much harder to punch.

Hit a Sidestepper twice quickly. If you're fast, you can flip it over before it scurries off to a different floor.

Punch pests near the edge of a floor so they fall to the level you are on.

SCORING: Here's how to earn points:

- Kick a pest off the floor:.....800 points
- Kick multiple pests off the floor quickly:
 - 1st pest.....800 points
 - 2nd pest.....1600 points
 - 3rd pest.....2400 points
 - 4th pest.....3200 points
 - Get or punch a coin.....800 points
 - Punch Slipice.....500 points
 - Punch green fireball.....200 points
 - Punch orange fireball.....1000 points
 - Punch a pest.....10 points

6.0 SCREENS

Push the TEST button to access the MAINMENU, Figure 1. It consists of a menu of all of the test and adjustment screens. Following Figure 1 is a description of each of the screens accessible through the MAIN MENU screen.

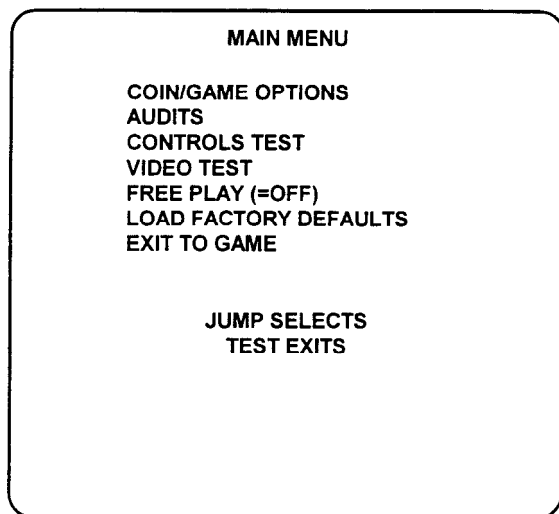

Figure 1: MAIN MENU

How to operate the MAIN MENU

Use the P1 joystick to move the cursor up or down.

Use the P1 jump button to make a selection or change a setting.

How to exit the MAIN MENU

Move the cursor to EXIT TO GAME and push the JUMP button, or press the TEST button.

6.1 COIN/GAME OPTIONS (FIGURE 2)

This screen provides a means to adjust the coin settings and game options..

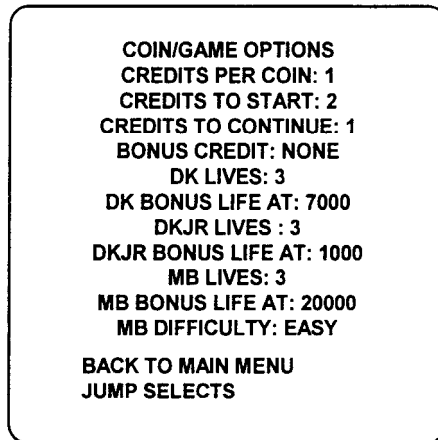

Figure 2: COIN/GAME OPTIONS

Use the P1 joystick to move the cursor up or down.

Use the P1 Jump button to make changes or select.

6.2 AUDITS (FIGURE 3)

The AUDITS screen is used to track number of games played, and includes 1P, 2P and Continues.

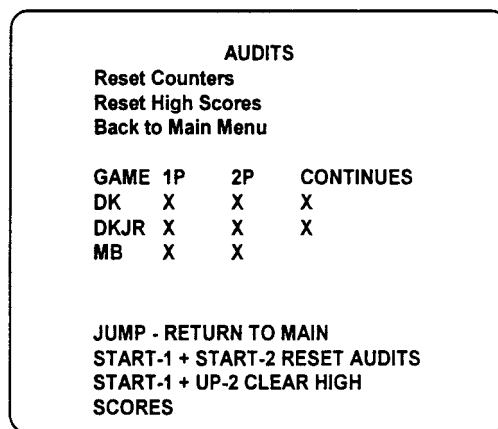

FIGURE 3: AUDITS SCREEN

6.3 CONTROLS TEST (FIGURE 4)

This screen is used for testing the input devices.

1. On the main screen, select "CONTROLS TEST" and execute.

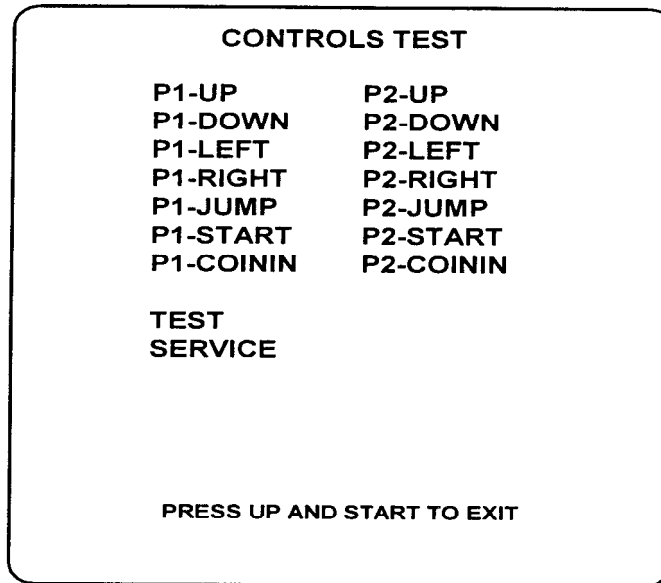

Figure 4: CONTROLS TEST SCREEN

2. When there is an input to each switch, the item on-screen will change color.
Press UP AND START TO EXIT. The monitor goes back to the main screen.

6.4 VIDEO TESTS SCREEN (FIGURE 5)

This screen allows the operator to check picture alignment and color.

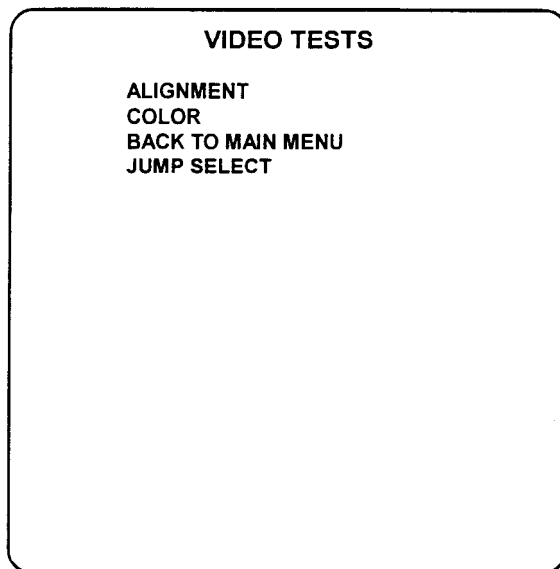

Figure 5: VIDEO TESTS SCREEN

6.5 LOAD FACTORY DEFAULTS SCREEN (FIGURE 6)

This screen allows the operator to reset all settings to factory defaults.

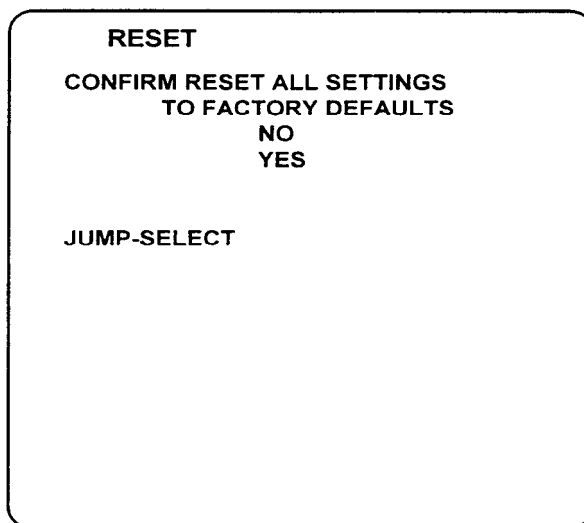

FIGURE 6: LOAD FACTORY DEFAULTS SCREEN

7.0 MAINTENANCE

7.1 MONITOR SERVICE

The 25-inch CGA monitor does not require regular maintenance, and there are no user-serviceable parts inside.

If a monitor malfunction occurs while your game is under warranty, contact your Distributor for assistance.

8.0 TROUBLESHOOTING

Problem		Probable Cause		Solution
No video or sound.	1)	JAMMA connector loose.	1)	Check JAMMA connector to verify it is connected securely to the main pcb.
	2)	No AC power.	1)	Check main AC fuse in back of cabinet. If fuse is OK, check voltage across input side of EMI filter. Should be 115-120VAC. If no voltage, then ON/OFF switch is bad, replace. If EMI filter input voltage is good, check voltage at the output (load side) of EMI filter. If no voltage, EMI filter is bad, replace. Verify that monitor harness is plugged in.
	3)	No DC power.	2)	Check DC output voltage at 12-pin connector. RED to BLK should be 5+/- .15VDC. ORG to BLK should be 12VDC -0/+1.8VDC.
	4)	Main PCB problem.	3)	NOTE: DO NOT ATTEMPT TO REPAIR PCBs OR WARRANTY WILL BE VOIDED. If main PCB is suspected bad, verify by swapping with known good unit. If service is req'd, contact your Distributor.
No audio.	1)	Wires loose, or incorrectly connected.	1)	Check wires on JAMMA connector.
	2)	Sound output set too low.	2)	Adjust audio volume using the adjustment knob located on the service panel.
Distorted audio.	1)	Volume set too high.	1)	Adjust with knob on service panel.
	2)	Main PCB problem.	2)	Replace PCB.
	3)	Incorrect speaker impedance.	3)	Verify 8 ohm speakers.
Distorted video.	1)	Video interface problems between Main PCB, FC PCB and/or CD PCB.	1)	Reseat cards. If problem persists, PCB set requires service.
	2)	Interference from audio ckt.	2)	Confirm by reducing audio volume. If interference goes away, check wiring around JAMMA connector. Wires should be well routed.

9.0 PARTS LIST**CABINET ASSEMBLY - UPRIGHT**

Part Number	Description
DJ40-11285-00	DECAL, CABINET SIDE, LEFT
DJ40-11285-01	DECAL, CABINET SIDE, RIGHT
DJ40-11287-00	DECAL, FRONT CABINET
DJ40-11286-00	FRONT GLASS WITH GRAPHICS
DJ40-11283-00	MARQUEE, STYRENE
DJ05-11292-00	ASSY, CPU RACK
VG85-09701-00	MONITOR, 25" CGA, WGM2574-U4GR60L
VG88-11009-00	POWER SUPPLY, IMPERIAL UP48UTC

CONTROL PANEL ASSEMBLY - UPRIGHT

Part Number	Description
DJ40-11284-00	DECAL, CONTROL PANEL OVERLAY
SI80-11017-00	ASSY, JOYSTICK, 4-WAY, LONG SHAFT, IMPERIAL # 47-9075-00
	PUSHBUTTON W/MICROSWITCH, HORIZONTAL, BLUE
	PUSHBUTTON W/MICROSWITCH, HORIZONTAL, ORANGE

CABINET ASSEMBLY - CABARET

Part Number	Description
DJ40-11291-00	DECAL, CABINET SIDE, LEFT
DJ40-11285-01	DECAL, CABINET SIDE, RIGHT
DJ40-11290-00	DECAL, FRONT PANEL
DJ40-11322-00	DECAL, MONITOR BEZEL, LEFT
DJ40-11322-01	DECAL, MONITOR BEZEL, RIGHT
DJ40-11288-00	MARQUEE, DONKEY KONG CABARET
DJ05-11292-00	ASSY, CPU RACK
VG85-09701-00	MONITOR, 25" CGA, WGM2574-U4GR60L

VG88-11009-00	POWER SUPPLY, IMPERIAL UP48UTC
---------------	--------------------------------

CONTROL PANEL ASSEMBLY - CABARET

Part Number	Description
DJ40-11289-00	DECAL, CONTROL PANEL OVERLAY
SI80-11017-00	ASSY, JOYSTICK, 4-WAY, LONG SHAFT, IMPERIAL # 47-9075-00
	PUSHBUTTON W/MICROSWITCH, HORIZONTAL, BLUE
	PUSHBUTTON W/MICROSWITCH, HORIZONTAL, ORANGE

APPENDIX A: WIRING DIAGRAM

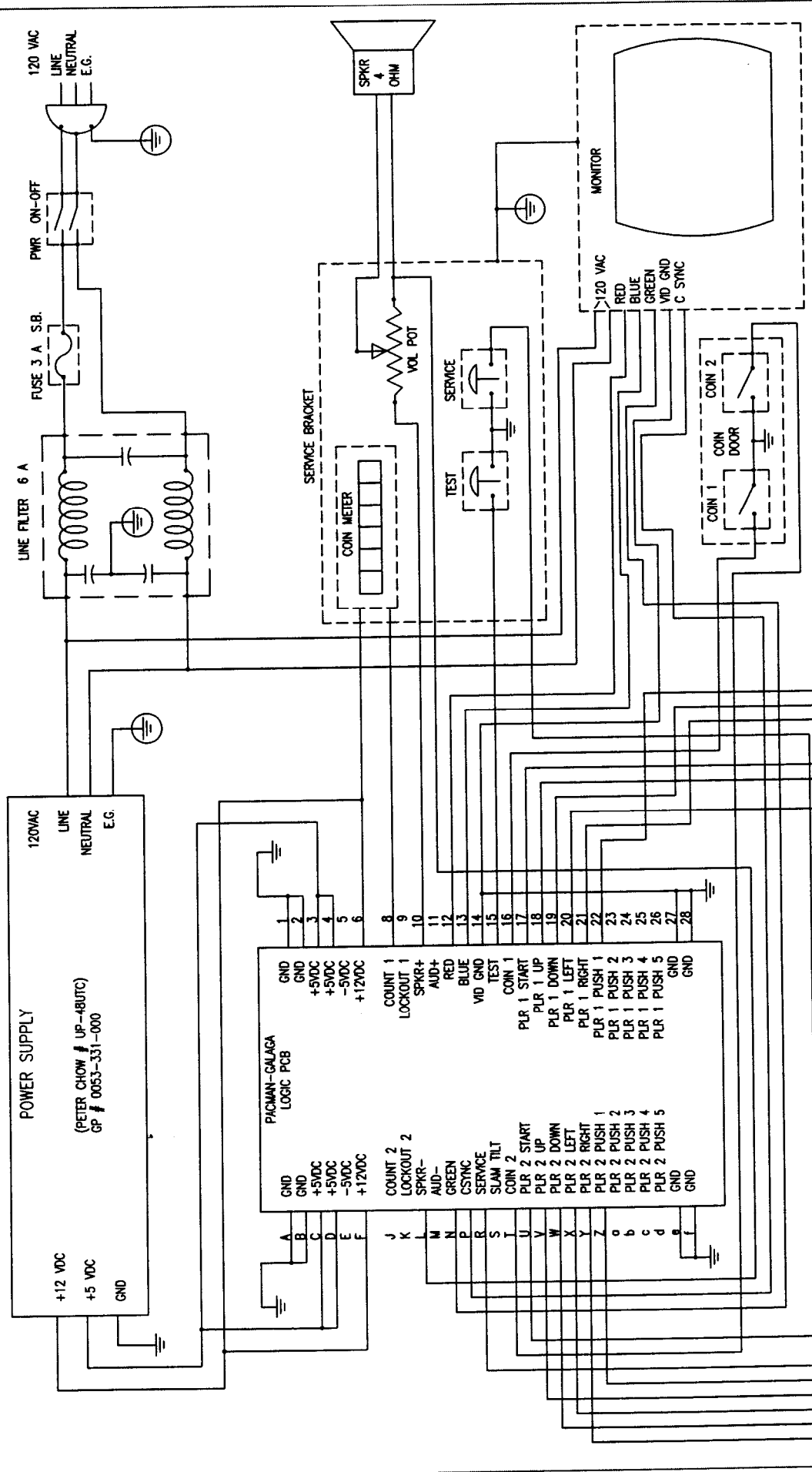

GRAND PRODUCTS INC.
 1757 S. WINTHROP DR. DES PLAINES, IL 60018 PH(847)795-0400

TITLE: DONKEY-KONG GAME: DONKEY-KONG UPRIGHT

SCALE:	QTY PER GAME:	DRAWN: R.D
DATE: 10/29/04	MATERIAL:	
TOL: X ±.030	MAI2	
XX ±.015	FINISH:	
.XXX ±.005	ACAD FILE: DONKEY-KONG	
HOLES: --0	PART NO.:	
ANGLES: ±Z		

SHEET SHEET

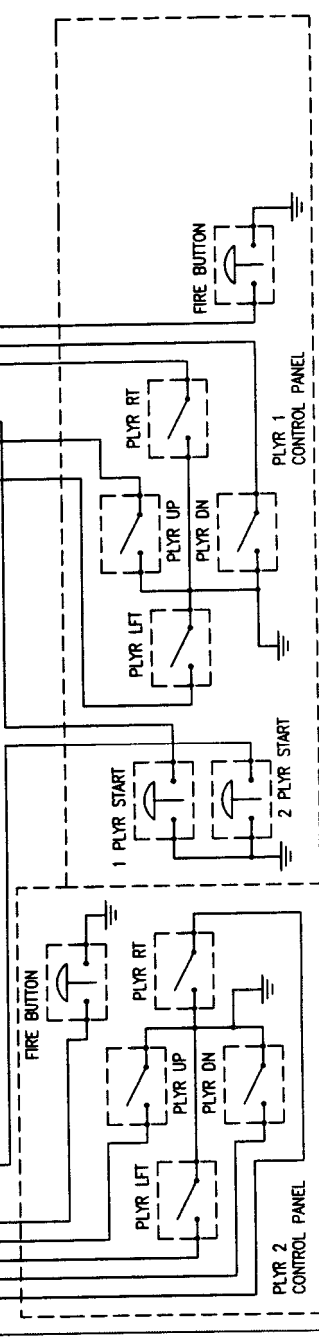

May be equipped with a Neo-Tec model NT-2500 color monitor.

WARRANTY

Seller warrants that its printed circuit boards and parts thereon are free from defects in materials and workmanship under normal use and service for a period of ninety (90) days from the date of shipment. Seller warrants that its video displays (in games supplied with video displays) are free from defects in material and workmanship under normal use and service for a period of thirty (30) days from the date of shipment. None of the Seller's other products or parts thereof are warranted. Seller's sole liability shall be, at its option, to repair, replace, or credit Buyer's account for such products which are returned to Seller during said warranty period, provided:

- a) Seller is promptly notified in writing upon discovery by Buyer that said products are defective
- b) Such products are returned prepaid to Seller's plant, and
- c) Seller's examination of said products discloses to Seller's satisfaction that such alleged defects existed and were not caused by accident, misuse, neglect, alteration, improper repair, improper installation, or improper testing.

In no event shall Seller be liable for loss of profits, loss of use, incidental or consequential damages.

Except for any express warranty set forth in a written contract between Seller and Buyer which contract supersedes the terms herein, this warranty is in lieu of all other warranties expressed or implied, including the implied warranties of merchantability and fitness for a particular purpose, and all other obligations or liabilities on the Seller's part, and it neither assumes nor authorizes any other person to assume for the Seller any other liabilities in connection with the sale of products by Seller.

Namco America Inc. distributors are independent, being privately owned and operated in their judgment they may sell parts or accessories other than **Namco America Inc.** parts or accessories. **Namco America Inc.** cannot be responsible for the quality, suitability or safety of any non-**Namco America Inc.** part or any modification including labor which is performed by such distributor.

SERVICE

If you have questions regarding any **Namco America Inc.** product or require technical support

Contact **Namco America Inc.** Customer Service at

1 (408) 383-3984 or FAX (408) 436-9554

Hours: 7:00 am - 4:00 pm PDT

Parts and repair services for **Namco America Inc.**

products are available through your distributor

NAMCO AMERICA INC.

890 Service St. # C

San Jose, CA 95112

(408) 383-3900

FAX: (408) 436-9554

Technical Assistance (USA)

(408) 383-3984

Fax: (408) 436-9554

Reorder Number DJ45-11324-00

REV A 11/08/04

The specifications of this machine and the instructions in this Operation Manual are subject to change without notice.