

FABEK

1988

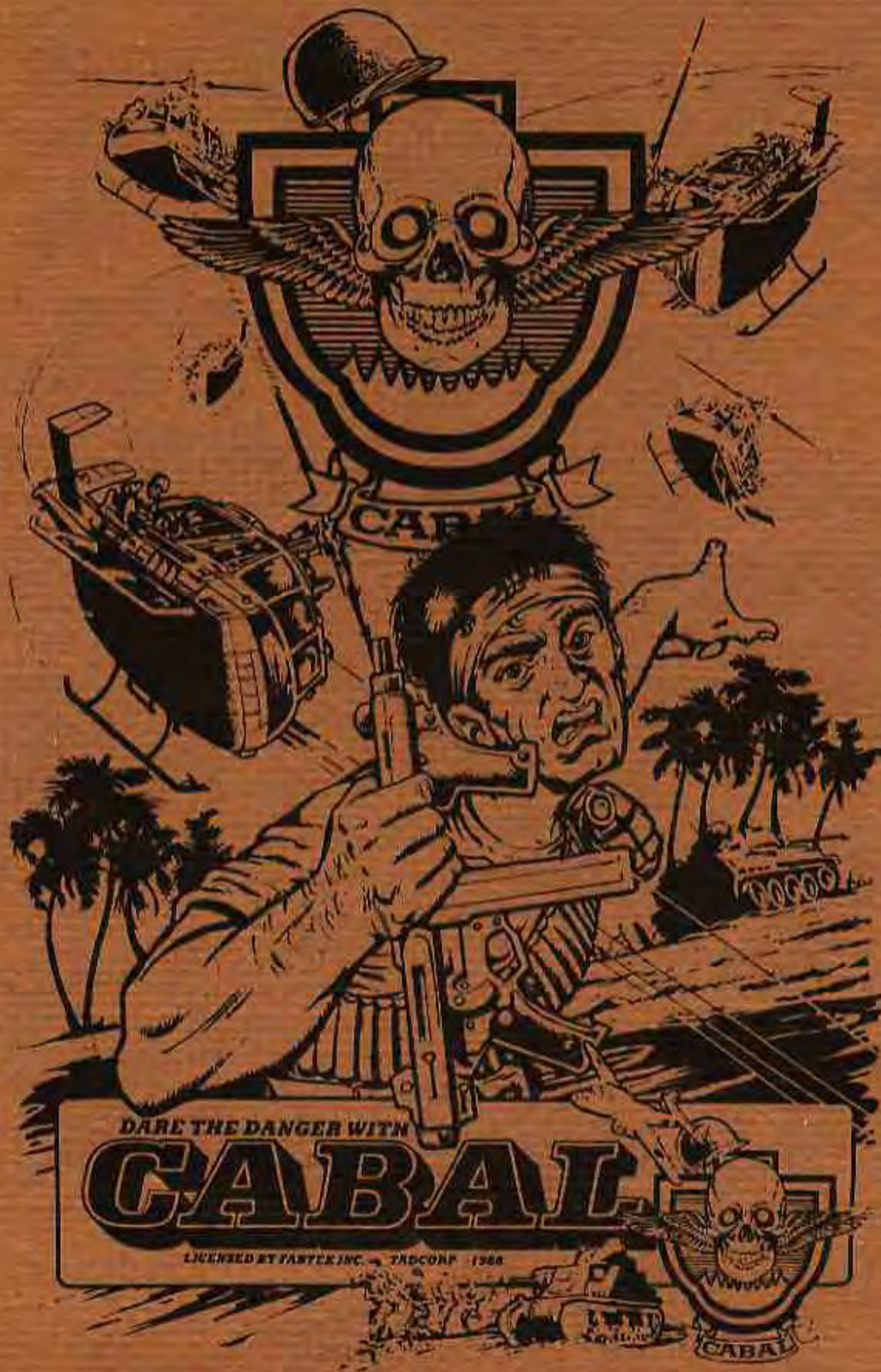

OWNERS MANUAL — CABAL®

VIDEO GAME OPERATOR:

Don't Get Involved In A Federal Crime. Don't Buy Or Operate Copy Or Unauthorized Boards In Your Games.

Warning



*Every operator who buys or operates a counterfeit or unauthorized board (imported or domestic) is contributing to the end of our industry and committing a **FEDERAL CRIME**.*

*New criminal laws have recently been enacted that provide for maximum penalties of \$250,000 or five years in prison or both, per offense. **EACH GAME IS A SEPARATE OFFENSE.***



WARNING

Federal law prohibits intent and actual penalties for the unauthorized reproduction, distribution, or exhibition of copyrighted audiovisual works and video games.

The Federal Bureau of Investigation investigates allegations of criminal copyright infringement.

If you have any information about any unauthorized games in the United States, contact your local FBI or,

 American Amusement Machine Association

205 The Strand
Suite 3
Alexandria, Virginia 22314
(703) 548-8044

All information will be treated in confidence.

SAFETY

The following topics should be carefully studied to insure maximum reliability and safety for both serviceman and customer. Shock Hazard: The high voltage present on the monitor may be very dangerous. Extreme caution must be used when working with or around the monitors. Be certain that the grounding strap is attached to the monitor frame. The picture tube in the monitor is also a hazard and should be handled with care. Do not strike, scratch, or subject the tube to more than moderate pressure as it may implode causing serious injury from flying glass. Be certain that the control panel, power supply monitor, and coin door are all properly grounded to the ground wire inside the line cord. Do not remove ground prong off plug end.

PARTS LIST

- 1 - Plex Marquee
- 1 - Control Panel Overlay
 - 1 - FCC Cage
 - 1 - Graphic Sheet
 - 2 - Side Graphics
 - 1 - Manual
 - 6 - Buttons
 - 1 - Jamma Cable
 - 1 - Marquee Art
- 2 - Track Balls & Mounting Hardware
 - 1 - Cabal PCB

FABTEK®

13807 NE 48 Place
Bellevue, WA 98005
(206) 882-1093

FOR SERVICE CONTACT:

SUMMIT SERVICE

2274 University Avenue
St. Paul, MN 55114
(612) 645-9077

CABAL® is protected by federal copyright laws and is the property of Fabtek®. Any unauthorized versions of this game are illegal by federal law. AAMA protected stickers must be attached to the PCB. Please notify Fabtek® of any boards not having the AAMA seal.

IMPORTANT F.C.C. WARNING

WARNING

THIS EQUIPMENT GENERATES AND CAN RADIATE RADIO FREQUENCY ENERGY; IF NOT INSTALLED AND USED IN ACCORDANCE WITH THE INSTRUCTION MANUAL, IT MAY CAUSE INTERFERENCE WITH RADIO COMMUNICATIONS. AS TEMPORARILY PERMITTED BY REGULATION, IT HAS NOT BEEN TESTED FOR COMPLIANCE PURSUANT TO SUBPART J OF PART 15 OF FCC RULES, WHICH ARE DESIGNED TO PROVIDE REASONABLE PROTECTION AGAINST SUCH INTERFERENCE. OPERATION OF THIS EQUIPMENT IN A RESIDENTIAL AREA IS LIKELY TO CAUSE INTERFERENCE IN WHICH CASE THE USER, AT HIS OWN EXPENSE, WILL BE REQUIRED TO TAKE WHATEVER MEASURES NECESSARY TO CORRECT THE INTERFERENCE.

DANGER

An isolation transformer must be used with the monitor and power supply.

This game must be equipped with a three wire 110 volt plug for safety. Under no circumstance remove the ground plug.

DANGER

This game is designed with a JAMMA 56 pin connector. This plug is one of the finest operator friendly features in our industry today. What this means to you is that:

- 1) 1, 2, A, B, 27, 28, e and f are grounded
- 2) 3, 4, C and D are +5 volts
- 3) 5 and E are -5 volts
- 4) 6 and F are +12 volts

Also, all video and joystick functions are always in the same place. Once a cabinet is wired for JAMMA, it is easily changed from game to game.

Many older games such as Pac Man®, etc., have the power supply on the board. This will not work!!! Only a JAMMA connector with proper voltage will work. Fabtek® recommends using an 11 amp switching power supply with **Cabal®**.

INSTALLATION OF KIT

To Disassemble:

1. Open back door and remove old board set and power supply, if you are using a new switching power supply.
2. Remove marquee glass and monitor glass.
3. Remove control panel and set aside.
4. Remove old wire harness, leaving 110 volt wiring intact. Also, leave the grounding straps to the monitor, coin door, control panel, and power supply intact.

Installation:

1. Mount the board set on the side panel of the cabinet as close to the middle of the game as possible (approximately 10-12" off bottom).

NOTE: Do not mount board directly below control or any vents or cracks so that liquids may seep on to the board. Do not forget about coins that may drop on to the board. Also, mount the board with edge connector facing up.

2. Mount the power supply on the bottom of the cabinet with connectors facing the rear of the cabinet. An optional mounting might be on the side panel just below the board set, connector to rear.
3. If the game does not have an isolation transformer, you must protect your customers and your game. Install one between the 110 volt line and your monitor/power supply.
4. Place the provided JAMMA wiring harness on the board. Connect the +5, +12, -5, and ground wires to the corresponding lugs on the power supply, connecting all the wires. If you don't, you will probably burn the board connector.
5. Run a wire from -5 volts to the coin door lights. Run a wire from +12 volts to the coin counters. This completes the power requirements.
6. Connect the Audio (+) and Audio (-) to the speaker.
7. Connect the video red, green, blue, ground, and sync to the corresponding wires on the monitor. If the monitor is not a negative composite sync, see sync modifications chart.
8. Cut the marquee to size. Replace the marquee lamp, if needed. Install the marquee panel.
9. Connect the coin 1 and coin 2 wires to the coin switches. Connect the coin counter 1 and coin counter 2 wires to the coin counters.

NOTE: If you only have one coin counter, see coin counter diagram. It will not matter if the coin counters are only rated at 6 volts, as the pulse is not long enough to burn out the counter.

10. Mounting the trackballs in your new Cabal® is as easy as 1, 2, 3. First you should choose a horizontal game cabinet. Next, the control panel must have adequate room for the two trackballs and buttons. With the 2¼" chassis punch, you will find it takes no more effort to mount a trackball than a joystick.

The trackball is wired so the wire coming out of the ball is at 7 o'clock. The black wire is ground, and the red wire is +5 volts. The X-axis (Xa and Xb) is the horizontal axis, and the Y-axis (Ya and Yb) is the vertical axis. If the trackball is rotated 90 degrees, the X and Y pairs of wires can be exchanged. If the cursor tracks left-to-right when moving the ball left, exchange Xa and Xb for that trackball. The end result is doing exactly what you would do if two wires were backwards on a joystick.

The recommended layout is spacing each trackball 1/3 of the way in from each side. If there is room the trackballs should be on the lower portion of the control panel. The shoot and grenade buttons are to be mounted in pairs on the side of the trackballs. If your player base demands it and you have the room, you may add two optional buttons for each player so each trackball has four buttons. The player starts can either be on top or on the left side. When laying out any control panel, place your hand on the panel as if you were playing the game so it feels comfortable. As an example; Don't place the buttons 3" apart.

Continue as following:

1. Drill a guide hole for the 2¼" chassis punch.
 2. Make the 2¼" hole using the chassis punch. (Greenlee chassis punch #5004059 2¼")
 3. Make necessary button holes.
 4. Install panel overlay.
 5. Mount Lexan (MR-5) over panel overlay as necessary and bevel edges.
 6. Using hole saw, make holes in Lexan as necessary.
 7. Mount assembly as necessary.
 8. When wiring switch common, make a closed loop to all buttons with common feeding player start 2.
11. Power up the game. Look over your installation for errors, and then apply power, listening for unusual sounds. Check for smoke or sparks. If everything is okay, wire tie all wires to form a nice, neat wiring harness. Clean the cabinet inside and out. Measure the +5 volts on the board, at the furthest point from the edge connector and adjust 5 volts to 5.05 volts. Use a tinted plex over the monitor if there are burns in the screen. We suggest bronze or grey tinted plex. Touch up the cabinet with fresh paint, and then repair all cabinet dents or chips, using an auto body product called **Duraglass**. This is similar to bondo. You can consult your local auto body shop or auto parts supplier for this product, as well as advice on how to use it.

NOTE: If you are going to use plexiglass over the control panel, we suggest that you use a good ½" polycarbonate with a scratch resistant coating. We recommend GENERAL ELECTRIC LEXAN MR5 with margard or TUFFAK CM-2. These do not crack or break with abuse.

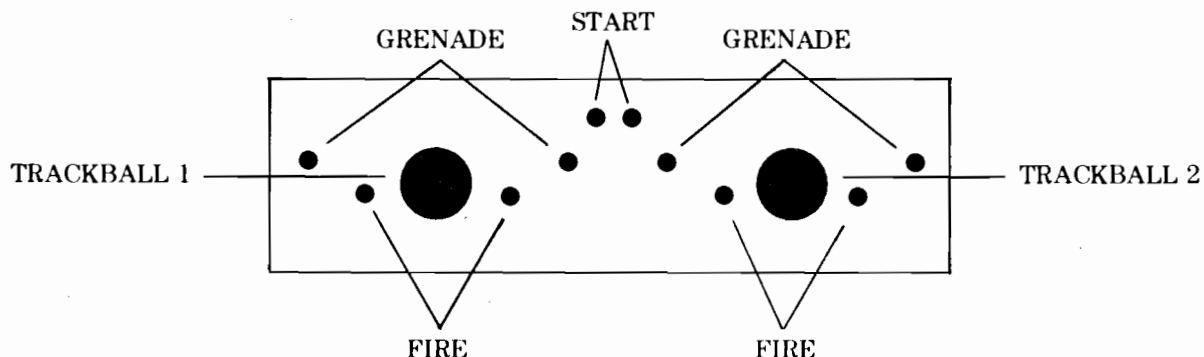

CABAL® by Fabtek®

Fabtek® is dedicated to being the most operator-oriented company in the game industry. In respect to you, the operator, this means several things, such as:

- 1) Having the clearest instructions possible so that you can minimize the time it takes to put the game together;
- 2) Providing useful information to help you produce the best-looking and highest earning game from your Fabtek® Kit;
- 3) Informing you of the proper setting for your game in both street and arcade locations. This is a first for the game industry; we realize that the differentiation between these two types of locations is important, and we want to help you prepare your game so that you can maximize your profits accordingly.
- 4) Continuing to keep the operator informed by publishing all service bulletins in the **Star Tech Journal** and in all other Trade Magazines.

To accomplish all of this, Fabtek® uses more operator input. Our games are made to be operated by operators such as yourself; you need all the information you can get today in order to make a maximum profit.

We would like to thank you for purchasing your new Fabtek® game. We are sure that the Fabtek® way will bring you back to us, game after game. Happy remunerations!

CABAL® "TRACK BALL ADAPTOR"

CABAL® track ball adaptor (to be connected between track ball and edge connector). Track balls which are made in Japan specification is OPEN EMITTER. In order to have the track balls function properly with the track balls not made in Japan, you must use the adaptor below to make the specification OPEN COLLECTOR.

Edge Connector Side

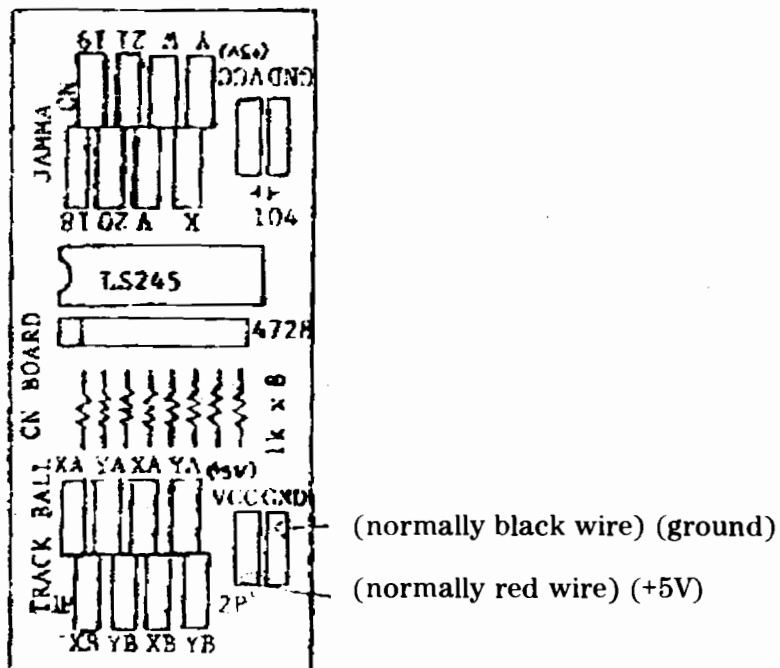

Track Ball Side YA YB

MONITORS

Cabal® is designed to be operated with a horizontal raster scan monitor with negative sync (RGB). This means **Cabal**® will not work with any X-Y (Tempest, Space Dual, Star Trek), etc. An isolation transformer must be used in conjunction with the monitor. This is for your safety. The monitor also utilizes extremely high voltages. The monitor may also retain a charge for an extended period of time. Safety goggles must be worn while removing or replacing the monitor.

It is highly recommended that the monitor is verified good before the new **Cabal**® kit is installed in your new and or rebuilt cabinet.

Cabal®, **Dynamo**® style

Fabtek® is concerned that your Fabtek® game will out earn the competition by 20 percent. The cabinet your kit is installed in will have a major effect on how much money it earns. Installing the game in a used cabinet that has already been kitted several times may not be the best way to maximize profits.

In arcade locations it is recommended installing **Cabal**® in the **Dynamo** 25 inch cabinet. We feel the game will earn 20 percent more money because of the 25 inch monitor and the creative styling of the **Dynamo** cabinet. With the JAMMA connector the game can be powered in about five minutes with only the control panel to be wired.

Dynamo® also has a 19 inch game cabinet for smaller street locations.

WICO COMMERCIAL TRACK BALL

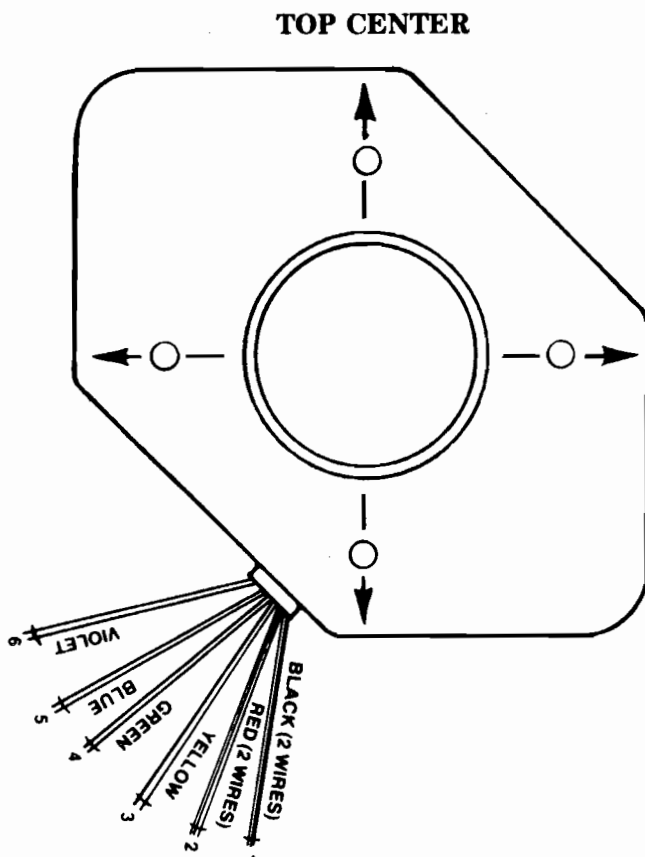

NOTE: Due to various manufacturers' electronic characteristics, you may find that your Trackball Unit, though properly orientated, is visually reversed on the video screen. To correct this problem, the following change(s) must be made to harness wires:

- 1) To switch HORIZONTAL direction (→), exchange the BLUE & VIOLET wires.
- 2) To switch VERTICAL direction (↑), exchange the YELLOW & GREEN wires.

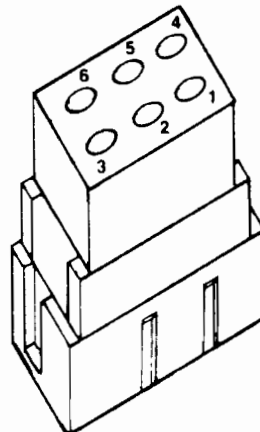

Star Tech Tips

We are grateful to Star Tech Journal™ for allowing us to publish the following excerpts from their journal.

Monitor Sync

If your monitor does not have dual polarity positions for sync, you may use one of the following methods to get your game going.

CURE 1: Install a simple one I.C. Circuit on your logic board. This I.C. may be "piggy backed" on to another 7404 series chip for power by bending up all but the two power pins so that they are parallel to the top surface of the new I.C. and then connecting the power pins only to the existing chip. (See Fig. 1) Next connect the sync wires as shown in Fig. 2. (Note: Figure 2 shows a hookup for either **composite** or **separate** syncs.)

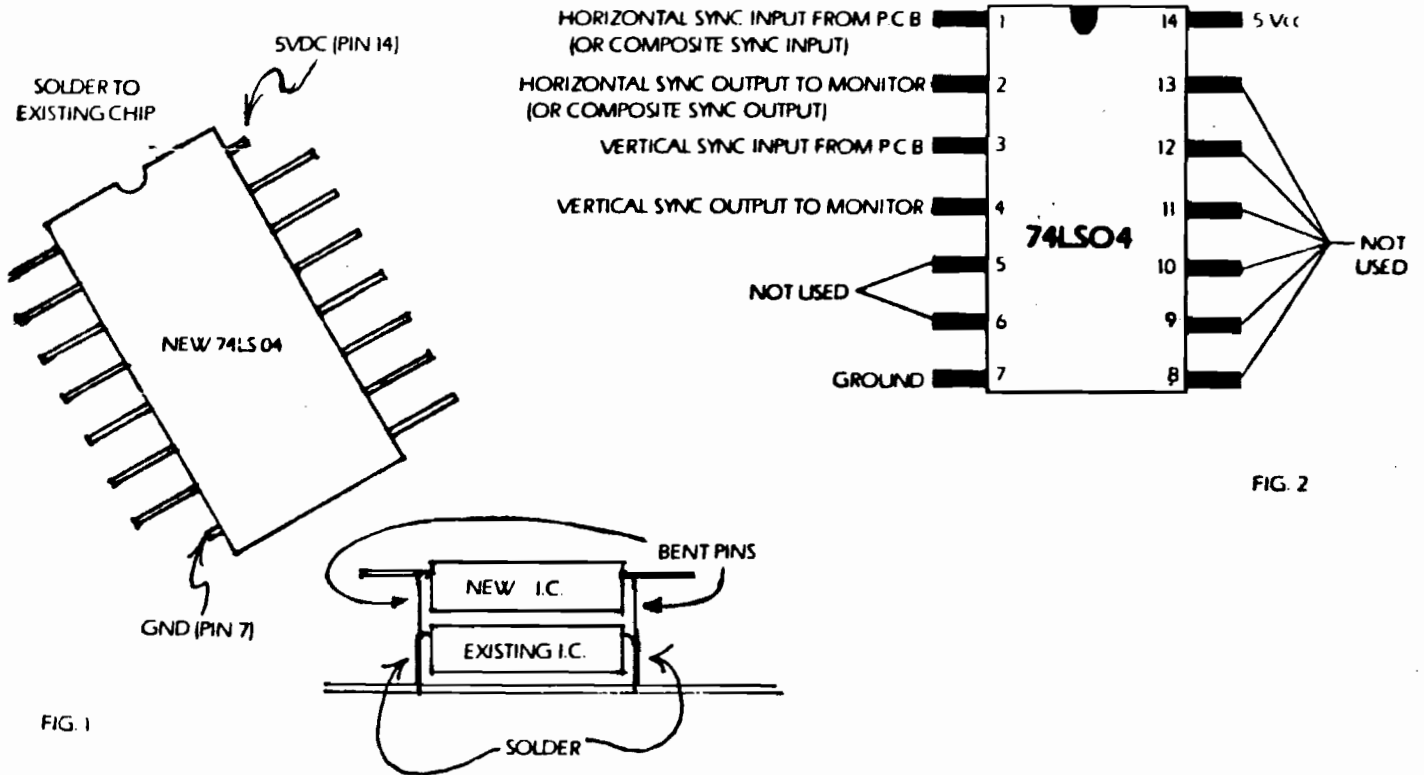

FIG. 2

CURE 2: Used for Wells-Gardner Video-Sync boards with positive sync connections only. (Vertical mount board 85x140B.

Cut the traces on the solder side of the board between input pins 5 & 6 to the unbanded (anode) ends of diodes X201 & X202.

Add MPSA56 transistor as follows:

Collector to anode leads of diodes X201 & X202. Base to pins 5 & 6 of the video input connector.

Emitter to cathode (banded) lead of zener diode ZD201.

Insert a 1N4148 diode - cathode to the emitter of the MPSA56 and anode to the base. (See Fig. 3)

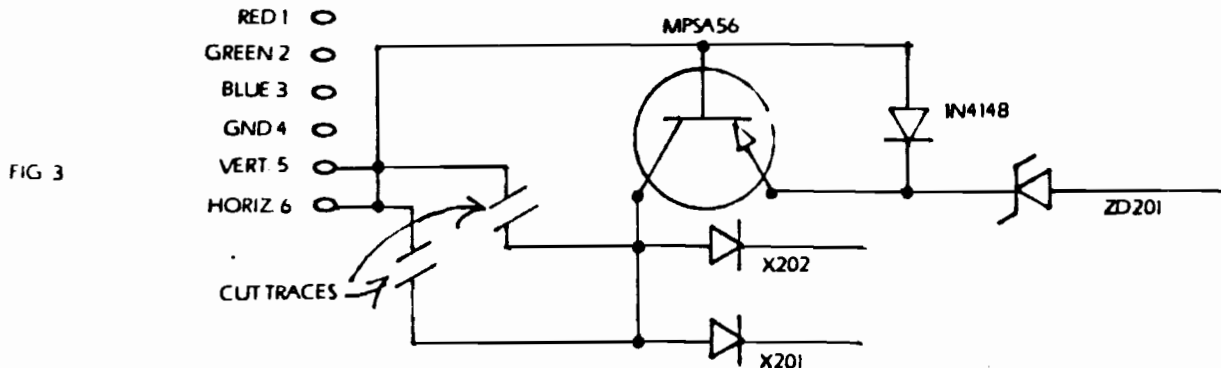

FIG. 3

2. Horizontal Tearing

CAUSE: The negative sync signal of most logic sets are slightly different than the GO7-CBO monitor negative sync inputs. The result of this mismatch is a horizontal "wave" or "curl".

CURE 1: On the monitor deflection board, replace C303 with a 10uf 25V radial lead capacitor with the positive lead towards the collector of X305. (CAUTION: be sure to check this step as the original cap is not polarized.) Then replace C501 with the cap removed from the C303 location.

CURE 2: Connect 1N4148 fast-switching diodes across both the positive and negative sync inputs to the monitor. (See Fig. 4) **NOTE:** Both diodes must be installed or you will not have vertical stability.

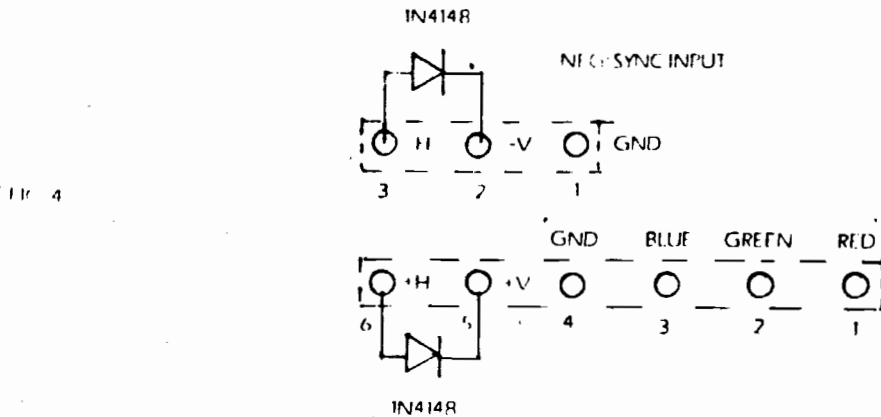

CURE 3: Join negative sync inputs J2 and J3 together with a jumper. Locate W102 and install a jumper from W102 to either J2 or J3.

CURE 3: For Wells-Gardner K4600 series monitors

Replace C356 (47uf 25V) on the Horizontal/vertical board (vertically mounted board nearest the flyback transformer) and center the horizontal hold pot. Turn L351 for the best horizontal stability and fine-tune with the horizontal width pot.

COIN COUNTER DIAGRAM

If only one coin counter is to be used install two diodes in the following manner:

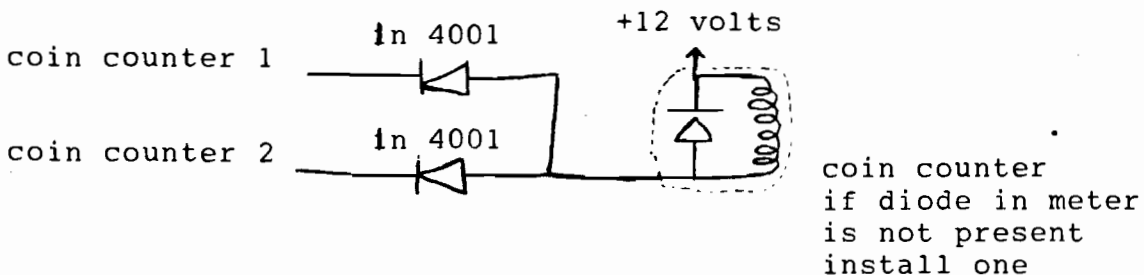

CABAL

SOLDER SIDE			COMPONENT SIDE		
BLACK	GROUND	A	1	GROUND	BLACK
BLACK	GROUND	B	2	GROUND	BLACK
RED	+5 VOLTS	C	3	+5 VOLTS	RED
RED	+5 VOLTS	D	4	+5 VOLTS	RED
YELLOW/GREEN	-5 VOLTS	E	5	-5 VOLTS	YELLOW/GREEN
ORANGE/BLACK	+12 VOLTS	F	6	+12 VOLTS	ORANGE/BLACK
		H	7		
GRAY/GREEN	COIN COUNTER 2	J	8	COIN COUNTER 1	WHITE/BLACK
		K	9		
VIOLET/YELLOW	SPEAKER -	L	10	SPEAKER +	VIOLET/RED
		M	11		
GREEN	VIDEO GREEN	N	12	VIDEO RED	RED
WHITE	VIDEO SYNC -	P	13	VIDEO BLUE	BLUE
		R	14	VIDEO GROUND	BLACK
		S	15		
GRAY/YELLOW	COIN SWITCH 2	T	16	COIN SWITCH 1	GRAY/BLUE
GRAY/RED	START SWITCH 2	U	17	START SWITCH 1	WHITE/GRAY
GRAY/BROWN	2P CONTROL XA	V	18	1P CONTROL XA	WHITE/GREEN
WHITE/YELLOW	2P CONTROL XB	W	19	1P CONTROL XB	WHITE/BLUE
WHITE/RED	2P CONTROL YA	X	20	1P CONTROL YA	BLUE/GREEN
YELLOW/BROWN	2P CONTROL YB	Y	21	1P CONTROL YB	BROWN/YELLOW
RED/GRAY	2P PUSH 1	Z	22	1P PUSH 1	YELLOW/BLACK
RED/WHITE	2P PUSH 2	a	23	1P PUSH 2	BLUE/BLACK
		b	24		
		c	25		
		d	26		
BLACK	GROUND	e	27	GROUND	BLACK
BLACK	GROUND	f	28	GROUND	BLACK

**BLANK SPACES ARE NOT USED.
X AXIS=LEFT,RIGHT (HORIZONTAL)

Y AXIS=UP,DOWN (VERTICAL)

DIP SW 1

option		sw	1	2	3	4	5	6	7	8	
coin mode select		mode 1					off				
		mode 2					on				
mode 1		1 coin 1 play	off	off	off	off					
		2 " 1 "	on	off	off	off					
		3 " 1 "	off	on	off	off					
		4 " 1 "	on	on	off	off					
		5 " 1 "	off	off	on	off					
		6 " 1 "	on	off	on	off					
		1 " 2 "	off	on	on	off					
		1 " 3 "	on	on	on	off					
		1 " 4 "	off	off	off	on					
		1 " 5 "	on	off	off	on					
		1 " 6 "	off	on	off	on					
		2 " 3 "	on	on	off	on					
		3 " 2 "	off	off	on	on					
		5 " 3 "	on	off	on	on					
		8 " 3 "	off	on	on	on					
		Free Play		on	on	on	on				
mode 2		coin selector A	1 coin 1 play	off	off						
			2 " 1 "	on	off						
			3 " 1 "	off	on						
			5 " 1 "	on	on						
		coin selector B	1 coin 2 play			off	off				
1 coin 3 play			on	off							
1 coin 5 play			off	on							
1 coin 6 play			on	on							
Button A B exchange		normal					off				
		invert					on				
TV invert		normal							off		
		invert							on		
track ball		small								off	
		large								on	

DIP SW 2

option		sw	1	2	3	4	5	6	7	8
# of lives at start		3	off	off						
		2	on	off						
		5	off	on						
		unlimited	on	on						
increase # of lives		150K - 500K			off	off				
		200K - 600K			on	off				
		300K - 700K			off	on				
		300K - not increase			on	on				
difficulty		level 1					off	off		
		level 2					on	off		
		level 3					off	on		
		level 4					on	on		
attract mode sound		yes								off
		no								on

